



SPC BENCHMARK 1™

FULL DISCLOSURE REPORT

**HUAWEI TECHNOLOGIES CO., LTD
HUAWEI OCEANSTOR 5500 V5**

SPC-1 V3.7

SUBMISSION IDENTIFIER: A31014

SUBMITTED FOR REVIEW: JULY 9 2018

First Edition – July 2018

THE INFORMATION CONTAINED IN THIS DOCUMENT IS DISTRIBUTED ON AN AS IS BASIS WITHOUT ANY WARRANTY EITHER EXPRESS OR IMPLIED. The use of this information or the implementation of any of these techniques is the customer's responsibility and depends on the customer's ability to evaluate and integrate them into the customer's operational environment. While each item has been reviewed by Huawei. for accuracy in a specific situation, there is no guarantee that the same or similar results will be obtained elsewhere. Customers attempting to adapt these techniques to their own environment do so at their own risk.

This publication was produced in the United States. Huawei may not offer the products, services, or features discussed in this document in other countries, and the information is subject to change with notice. Consult your local Huawei representative for information on products and services available in your area.

© Copyright Huawei 2018. All rights reserved.

Permission is hereby granted to publicly disclose and reproduce this document, in whole or in part, provided the copyright notice as printed above is set forth in full text on the title page of each item reproduced.

Trademarks

SPC Benchmark 1, SPC-1, SPC-1 IOPS, SPC-1 LRT and SPC-1 Price-Performance are trademarks of the Storage Performance Council.

Huawei, the Huawei logo, FusionServer™ and OceanStor are trademarks or registered trademarks of Huawei in the United States and other countries. All other brands, trademarks, and product names are the property of their respective owners.

Benchmark Specification and Glossary

The official SPC Benchmark 1™ (SPC-1™) specification is available on the website of the Storage Performance Council (SPC) at www.storageperformance.org.

The SPC-1™ specification contains a glossary of the SPC-1™ terms used in this publication.

Table of Contents

Audit Certification	4
Letter Of Good Faith	6
Executive Summary	7
Configuration Information	13
Benchmark Configuration and Tested Storage Configuration	13
Benchmark Configuration Creation Process	15
Benchmark Execution Results	16
Benchmark Execution Overview	16
SUSTAIN Test Phase	17
RAMPD_100 Test Phase	20
Response Time Ramp Test	23
Repeatability Test	25
Data Persistence Test	28
Appendix A: Supporting Files	29
Appendix B: Third Party Quotation	30
Appendix C: Tuning Parameters and Options	32
Appendix D: Storage Configuration Creation	34
Appendix E: Configuration Inventory	38
Appendix F: Workload Generator	39

AUDIT CERTIFICATION



Zhong Xu
 Huawei Technologies Co., Ltd.
 Huawei Industrial Base, Bantian,
 Longgang, Shenzhen city,
 Guangdong province, China

July 5, 2018

I verified the SPC Benchmark 1™ (SPC-1™ Revision 3.7) test execution and performance results of the following Tested Storage Product:

HUAWEI OCEANSTOR 5500 V5

The results were:

SPC-1 IOPS™	600,275
SPC-1 Price-Performance™	\$448.60/SPC-1 KIOPS™
SPC-1 IOPS™ Response Time	0.523 ms
SPC-1 Overall Response Time	0.381 ms
SPC-1 ASU Capacity	17,395 GB
SPC-1 ASU Price	\$15.49/GB
SPC-1 Total System Price	\$269,278.72

In my opinion, these performance results were produced in compliance with the SPC requirements for the benchmark.

The testing was executed using the SPC-1 Toolkit Version 3.0.2-1 build g823a. The audit process was conducted in accordance with the SPC Policies and met the requirements for the benchmark.

A Letter of Good Faith was issued by the Test Sponsor, stating the accuracy and completeness of the documentation and testing data provided in support of the audit of this result.

A Full Disclosure Report for this result was prepared by InfoSizing, reviewed and approved by the Test Sponsor, and can be found at www.spcresults.org under the Submission Identifier **A31014**.

A31014

HUAWEI OCEANSTOR 5500 V5

p.2

The independent audit process conducted by InfoSizing included the verifications of the following items:

- The physical capacity of the data repository;
- The total capacity of the Application Storage Unit (ASU);
- The accuracy of the Benchmark Configuration diagram;
- The tuning parameters used to configure the Benchmark Configuration;
- The Workload Generator commands used to execute the testing;
- The validity and integrity of the test result files;
- The compliance of the results from each performance test;
- The compliance of the results from the persistence test;
- The compliance of the submitted pricing model; and
- The differences between the tested and the priced configuration, if any.

The Full Disclosure Report for this result was prepared in accordance with the disclosure requirements set forth in the specification for the benchmark.

The following benchmark requirements, if any, were waived according to the SPC Policies:

- None.

Respectfully Yours,



François Raab, Certified SPC Auditor

LETTER OF GOOD FAITH



©Huawei Technologies Co., Ltd.

Huawei Industrial Base, Bantian, Longgang

Shenzhen city

Guangdong province

China

Tel: 0086-755-28780808

<http://www.huawei.com/en/>

Date: July 5, 2018

From: Huawei Technologies Co., Ltd.

To: Mr. Francois Raab, Certified SPC Auditor
InfoSizing
20 Kreg Lane
Manitou Springs, CO 80829

Subject: SPC-1 Letter of Good Faith for the Huawei OceanStor 5500 V5

Huawei Technologies Co., Ltd. is the SPC-1 Test Sponsor for the above listed product. To the best of our knowledge and belief, the required SPC-1 benchmark results and materials we have submitted for that product are complete, accurate, and in full compliance with V3.6 of the SPC-1 benchmark specification.

In addition, we have reported any items in the Benchmark Configuration and execution of the benchmark that affected the reported results even if the items are not explicitly required to be disclosed by the SPC-1 benchmark specification.

Signed:

Date:

Handwritten signature of Meng Guangbin, dated 2018.07.05.

Meng Guangbin

President of Storage Product Line



SPC BENCHMARK 1™

EXECUTIVE SUMMARY

HUAWEI TECHNOLOGIES CO., LTD HUAWEI OCEANSTOR 5500 V5

SPC-1 IOPS™	600,275
SPC-1 Price-Performance™	\$448.60/SPC-1 KIOPS™
SPC-1 IOPS™ Response Time	0.523 ms
SPC-1 Overall Response Time	0.381 ms
SPC-1 ASU Capacity	17,395 GB
SPC-1 ASU Price	\$15.49/GB
SPC-1 Total System Price	\$269,278.72
Data Protection Level	Protected 2 (RAID-10)
Physical Storage Capacity	42,960 GB
Pricing Currency / Target Country	U.S. Dollars / USA

SPC-1 V3.7

SUBMISSION IDENTIFIER: A31014

SUBMITTED FOR REVIEW: JULY 9, 2018

Benchmark Configuration Diagram

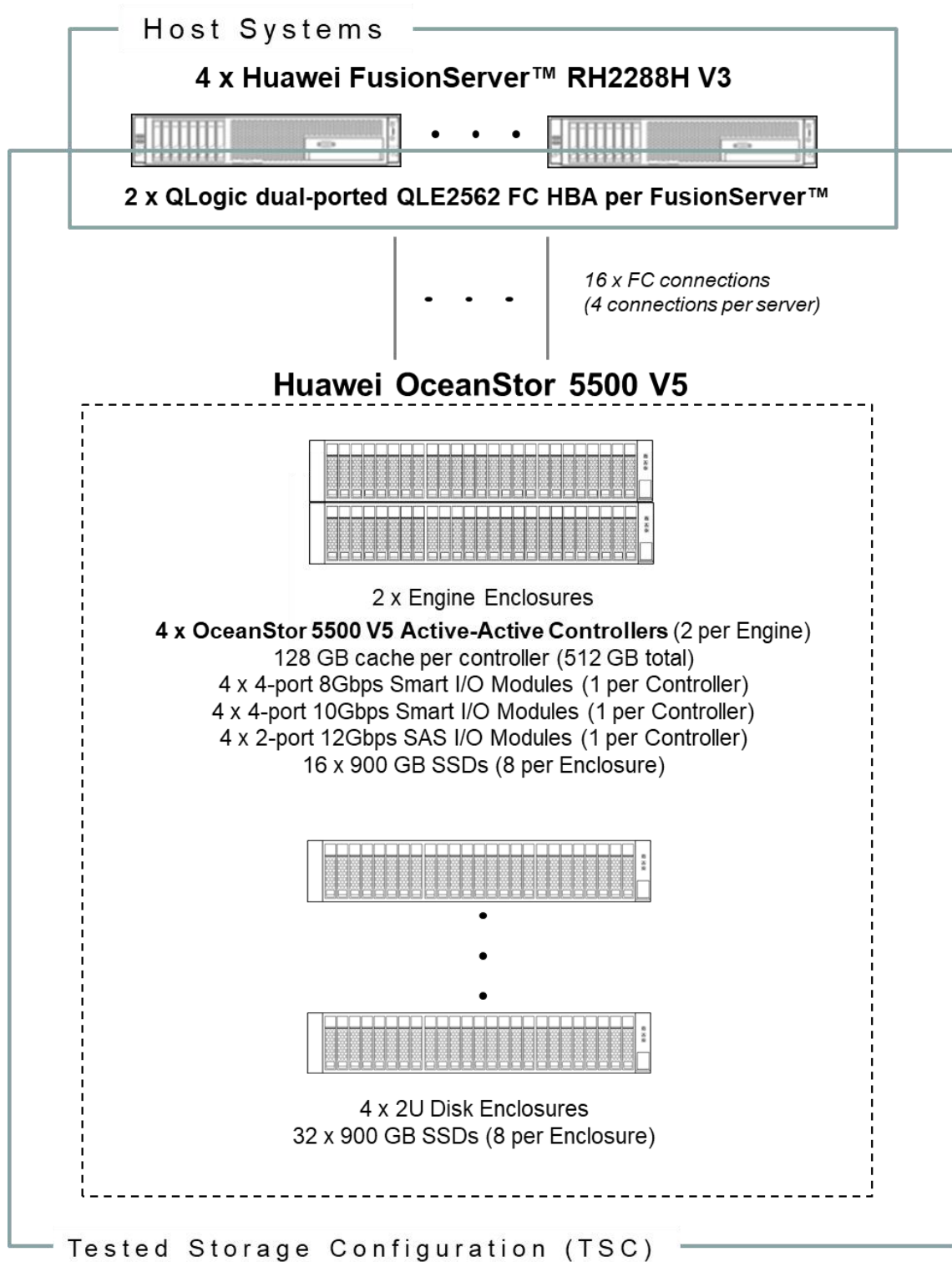

Tested Storage Product Description

The new generation of mid-range hybrid flash storage, dedicated to providing the reliable and efficient data services for enterprises.

Cloud-ready operating system, flash-enabled performance, and intelligent management software, delivering top-of-the-line functionality, performance, efficiency, reliability, and ease of use.

Satisfies the data storage requirements of large-database OLTP/OLAP, cloud computing, and many other applications, making it a perfect choice for sectors such as government, finance, telecommunications, and manufacturing.

For more details, visit:

<http://e.huawei.com/en/products/cloud-computing-dc/storage/massive-storage/5300-5500-5600-5800-v5>

Priced Storage Configuration Components

8 x QLogic dual-ported QLE2562 FC HBA
4 x OceanStor 5500 V5 Active-Active Controllers (2 per enclosure), each with: <ul style="list-style-type: none">128 GB cache (512 GB total)4 x 4-port 8Gbps Smart I/O Modules4 x 4-port 10Gbps Smart I/O Modules4 x 2-port 12Gbps SAS I/O Modules
2 x System enclosures, each with: <ul style="list-style-type: none">8 x 900 GB SSDs (16 total)
4 x 2U Disk enclosures, each with: <ul style="list-style-type: none">8 x 900 GB SSDs (32 total)

Storage Configuration Pricing

	Description	Qty	Unit Price	Ext. Price	Disc.	Disc. Price
Hardware & Software						
55V5-256G-2S-AC2-8FC	5500 V5 (2U, Dual Ctrl, AC\240HVDC, 256GB, SmartIO, 8*8Gb FC, 4 Port 4*12Gbps SAS, 25*2.5", SPE34C0225)	2	85,524.00	171,048.00	68%	54,735.36
SMARTIO10ETH	4 port SmartIO I/O module (SFP+, 10Gb Eth/FCoE (VN2VF)/Scale-out)	4	6,288.00	25,152.00	68%	8,048.64
HSSD-900G2S-A6	900GB SSD SAS Disk Unit (2.5")	48	9,096.00	436,608.00	70%	130,982.40
DAE52525U2-AC-A2	Disk Enclosure (2U, AC\240HVDC, 2.5", Expanding Module, 25 Disk Slots, without Disk Unit, DAE52525U2)	4	10,584.00	42,336.00	68%	13,547.52
N8GHBA000	QLOGIC QLE2562 HBA Card, PCIE, 8Gbps DualPort, Fiber Channel Multimode LC Optic Interface, English Manual, No Drive CD	8	1,698.00	13,584.00	0%	13,584.00
SN2F01FCPC	Patch Cord, DLC/PC, DLC/PC, Multi-mode, 3m, A1a.2, 2mm, 42mm DLC, OM3 bending insensitive	24	14.00	336.00	0%	336.00
LIC-55V5-BS	Basic Software License for Block (Including Device Manager, SmartThin, SmartMulti-tenant, SmartMigration, SmartErase, SmartMotion, UltraPath and SystemReporter)	1	8,676.00	8,676.00	70%	2,602.80
Hardware & Software Subtotal						223,836.72
Support & Maintenance						
02351QJY-88134ULF-36	5500 V5 (2U, Dual Ctrl, AC\240HVDC, 256GB, SmartIO, 8*8Gb FC, 4 Port 4*12Gbps SAS, 25*2.5", SPE34C0225 & 2*Disk Enclosure-2U, AC\240HVDC, 2.5", DAE52525U2&24*900GB SSD SAS Disk Unit(2.5"))-Hi-Care Onsite Premier 24x7x4H Engineer Onsite Service-36Month(s)	2	15,156.00	30,312.00	0%	30,312.00
88034JUH-88134UHK-36	Basic Software License for Block (Including Device Manager, SmartThin, SmartMulti-tenant, SmartMigration, SmartErase, SmartMotion, UltraPath and SystemReporter) - Hi-Care Application Software Upgrade Support Service-36Month(s)	1	2,085.00	2,085.00	0%	2,085.00
8812153244	OceanStor 5500 V5 Installation Service - Engineering	1	13,045.00	13,045.00	0%	13,045.00
Support & Maintenance Subtotal						45,442.00
SPC-1 Total System Price						269,278.72
SPC-1 IOPS™						600,275
SPC-1 Price-Performance™ (\$/SPC-1 KIOPS™)						448.60
SPC-1 ASU Capacity (GB)						17,395
SPC-1 ASU Price (\$/GB)						15.49

Third-Party Reseller: Huawei Technologies Co., Ltd. only sells its products to third-party resellers who, in turn, sell those products to U.S. customers. The above reflects the pricing quoted by one of those third-party resellers. See Appendix B of the Full Disclosure Report for a copy of the third-party reseller's quotation.

Discount Details: The discounts shown are based on the storage capacity purchased and are generally available.

Warranty: Hi-Care Premier On-Site Service include: 7x24 Technical Assistance Center Access. Access to all new software updates and Online Support. 24x7 with 4-hour On-site Hardware Replacement.

Availability Date: Currently available.

Response Time and Throughput Graph

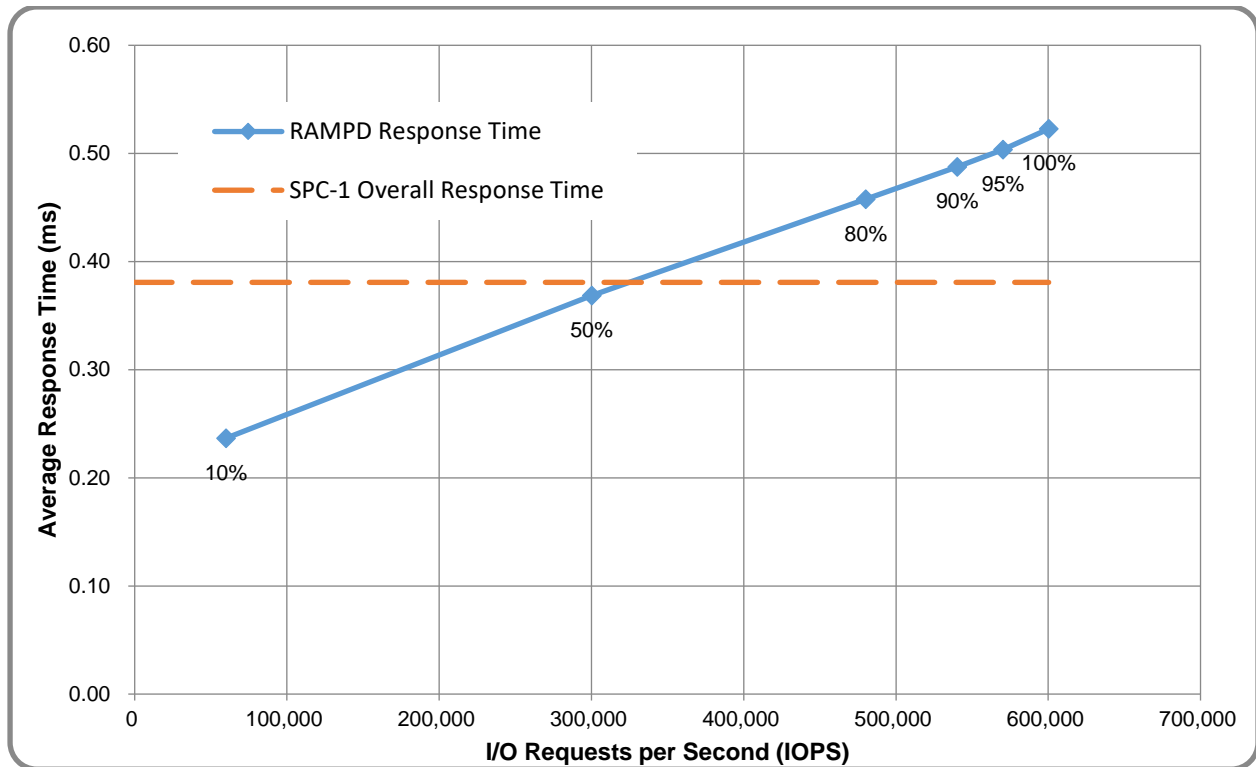

Contact Information	
Test Sponsor Primary Contact	Huawei Technologies Co., Ltd. – www.huawei.com Zhong Xu – xuzhong@huawei.com
SPC Auditor	InfoSizing – www.sizing.com Francois Raab – francois@sizing.com

Revision Information	
SPC Benchmark 1™ Revision	V3.7.0
SPC-1 Workload Generator Revision	V3.0.2-1 build g823a
Publication Revision History	First Edition

CONFIGURATION INFORMATION

Benchmark Configuration and Tested Storage Configuration

The following diagram illustrates the Benchmark Configuration (BC), including the Tested Storage Configuration (TSC) and the Host System(s).

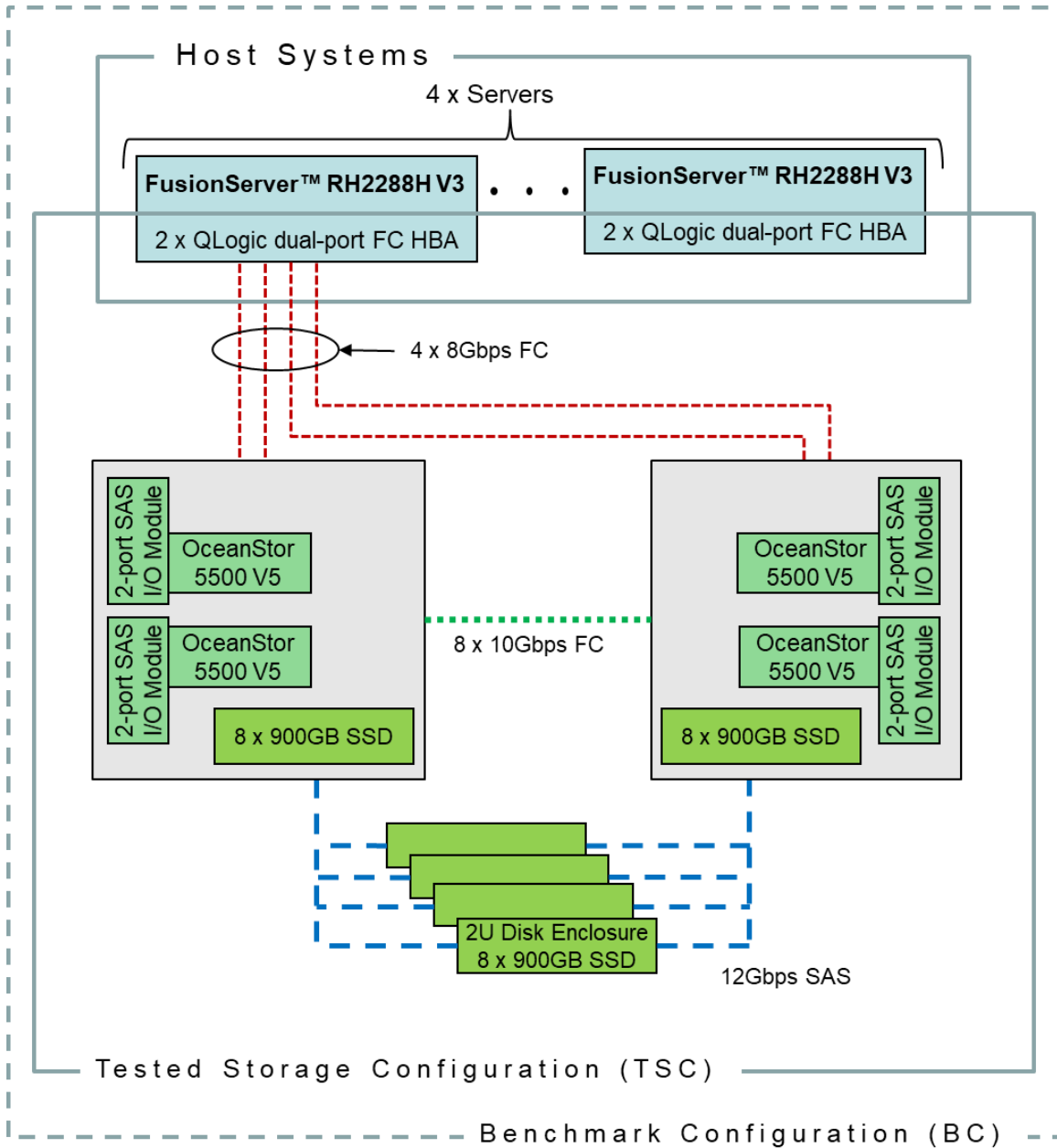

Storage Network Configuration

The Tested Storage Configuration (TSC) involved an external storage subsystem made of 4 Huawei OceanStor 5500 V5, driven by 4 host systems (Huawei FusionServer RH2288H V3). The OceanStor controllers were grouped in sets of 2, forming 2 OceanStor Engines. Each FusionServer host system connected one-to-one to each OceanStor Engine. That connection was established via a port from 1 of the 2 dual-port Fibre Chanel HBAs on the FusionServer; and a port from 1 of the 4 4-port Smart I/O Modules on the OceanStor Engine, leaving 12 of these ports inactive in each Engine. These Fibre Chanel paths operated at 8Gbps.

Host System and Tested Storage Configuration Components

The following table lists the components of the Host System(s) and the Tested Storage Configuration (TSC).

Host Systems
4 x Huawei FusionServer™ RH2288H V3 2 x Intel® Xeon® E5-2667 v4 (3.2 GHz, 8 Cores, 25 MB L3) 128 GB Main Memory Red Hat Enterprise Linux 7.1
Priced Storage Configuration
8 x QLogic dual-ported QLE2562 FC HBA 4 x OceanStor 5500 V5 Active-Active Controllers (2 per Engine), each with: 128 GB cache (512 GB total) 4 x 4-port 8Gbps Smart I/O Modules 4 x 4-port 10Gbps Smart I/O Modules 4 x 2-port 12Gbps SAS I/O Modules 2 x Engine enclosures, each with: 8 x 900 GB SSDs (16 total) 4 x 2U Disk enclosures, each with: 8 x 900 GB SSDs (32 total)

Differences Between Tested and Priced Storage Configurations

There were no differences between the Tested Storage Configuration and the Priced Storage Configuration.

Component Changes in Revised Full Disclosure Report

The following table outlines component changes that were made in revisions to this Full Disclosure Report.

Original Component	Revised Component	Description of Change
n/a	n/a	Initial submission

Benchmark Configuration Creation Process

Customer Tuning Parameters and Options

All the customer tuning parameters and options that have been altered from their default values for this benchmark are included in Appendix C and in the Supporting Files (see Appendix A).

Tested Storage Configuration Creation

A detailed description of how the logical representation of the TSC was created is included in Appendix D and in the Supporting Files (see Appendix A).

Tested Storage Configuration Inventory

An inventory of the components in the TSC, as seen by the Benchmark Configuration, is included in Appendix E and in the Supporting Files (see Appendix A).

Workload Generator Storage Configuration

The SPC-1 Workload Generator storage configuration commands and parameters used to invoke the execution of the tests are included in Appendix F and in the Supporting Files (see Appendix A).

Logical Volume Capacity and ASU Mapping

The following table details the capacity of each ASU and how they are mapped to logical volumes (LV).

	LV per ASU	LV Capacity	Used per LV	Total per ASU	% ASU Capacity
ASU-1	18	434.9	434.9	7,827.6	45.00%
ASU-2	18	434.9	434.9	7,827.6	45.00%
ASU-3	2	869.8	869.7	1,739.5	10.00%
SPC-1 ASU Capacity				17,394.6	

Physical Storage Capacity and Utilization

The following table details the Physical Capacity of the storage devices and the Physical Capacity Utilization (percentage of Total Physical Capacity used) in support of hosting the ASUs.

Devices	Count	Physical Capacity	Total Capacity
900GB SSD	48	895.0	42,960.0
Total Physical Capacity			42,960.0
Physical Capacity Utilization			40.49%

Data Protection

The data protection level used for all logical volumes was **Protected 2**, which was accomplished by configuring 16 pools of 18 drives into 16 RAID-10 arrays.

BENCHMARK EXECUTION RESULTS

This portion of the Full Disclosure Report documents the results of the various SPC-1 Tests, Test Phases, and Test Runs.

Benchmark Execution Overview

Workload Generator Input Parameters

The SPC-1 Workload Generator commands and input parameters for the Test Phases are presented in the Supporting Files (see Appendix A).

Primary Metrics Test Phases

The benchmark execution consists of the Primary Metrics Test Phases, including the Test Phases SUSTAIN, RAMPD_100 to RAMPD_10, RAMPU_50 to RAMPU_100, RAMP_0, REPEAT_1 and REPEAT_2.

Each Test Phase starts with a transition period followed by a Measurement Interval.

Measurement Intervals by Test Phase Graph

The following graph presents the average IOPS and the average Response Times measured over the Measurement Interval (MI) of each Test Phase.

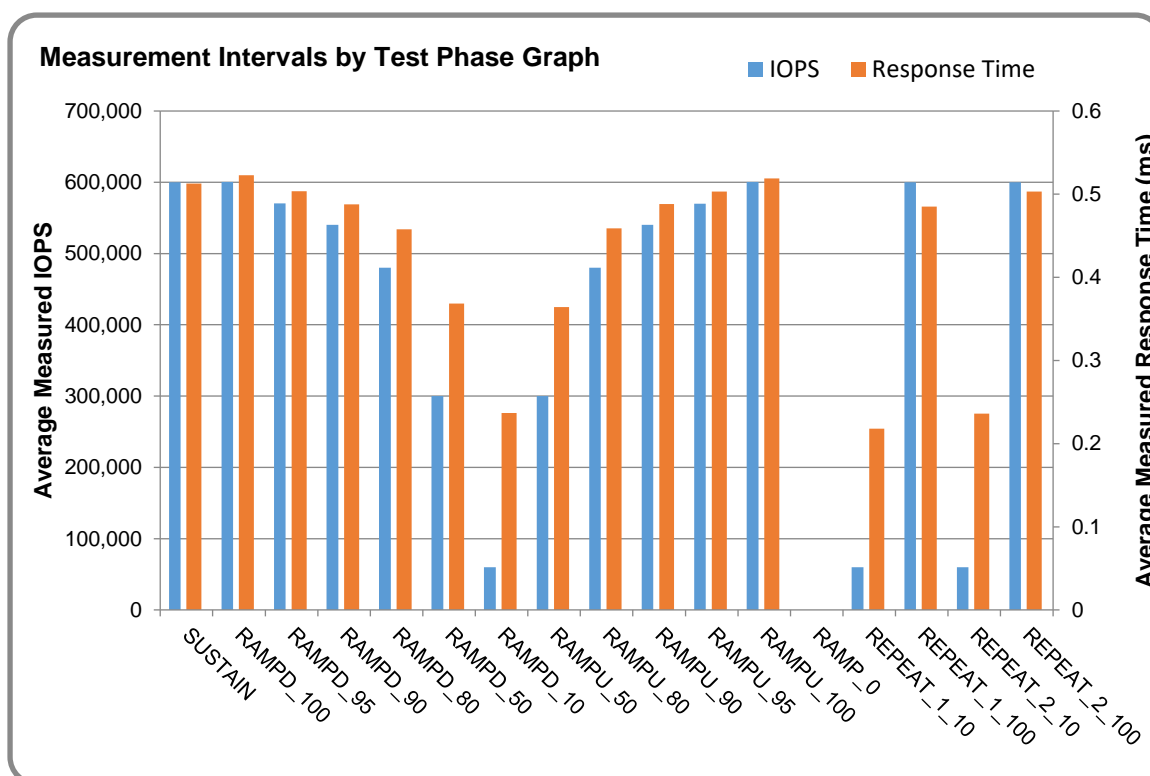

Exception and Waiver

None.

SUSTAIN Test Phase

SUSTAIN – Results File

The results file generated during the execution of the SUSTAIN Test Phase is included in the Supporting Files (see Appendix A) as follows:

- SPC1_METRICS_0_Raw_Results.xlsx

SUSTAIN – Execution Times

Interval	Start Time	End Time	Duration
Transition Period	29-Jun-18 12:29:11	29-Jun-18 22:29:11	10:00:00
Measurement Interval	29-Jun-18 22:29:11	30-Jun-18 06:29:12	8:00:01

SUSTAIN – Throughput Graph

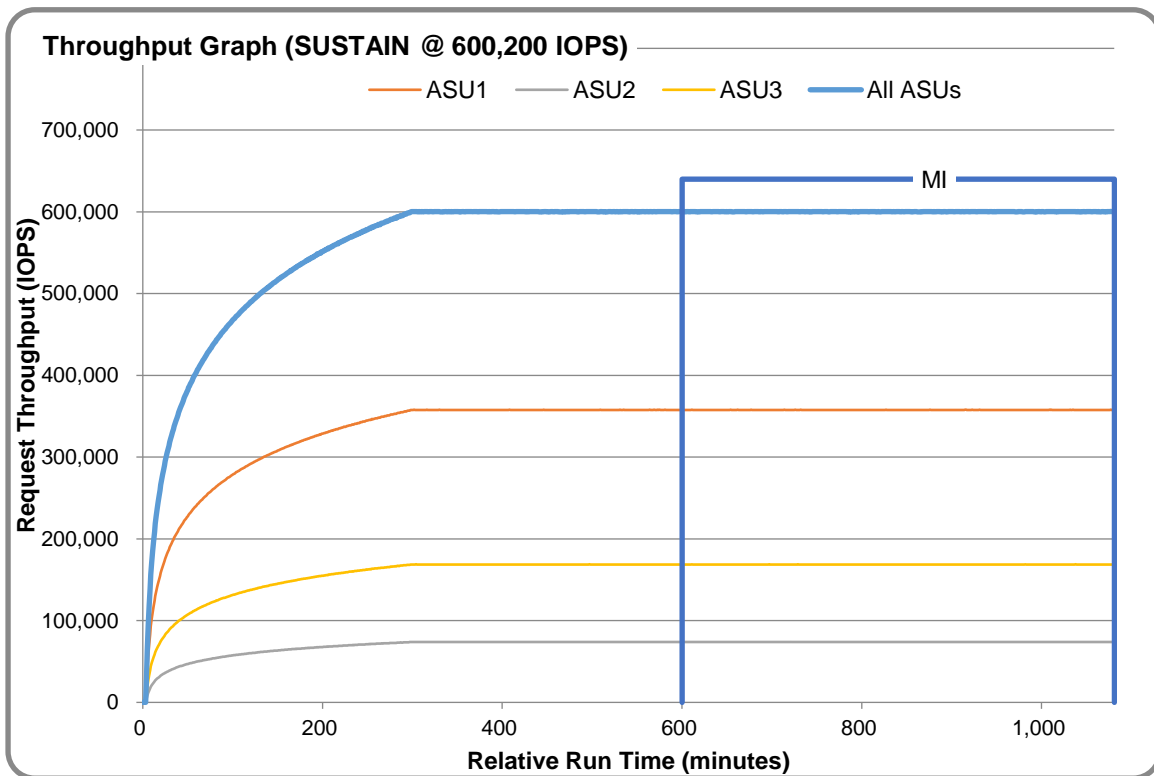

SUSTAIN – Response Time Graph

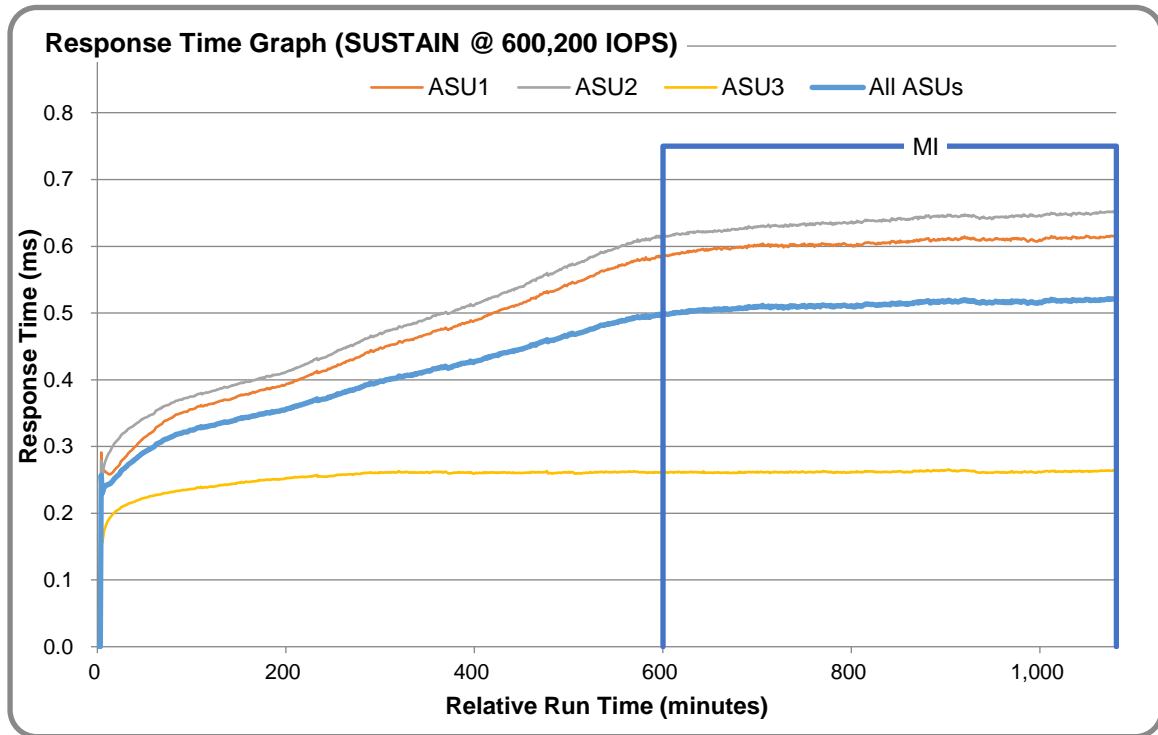

SUSTAIN – Data Rate Graph

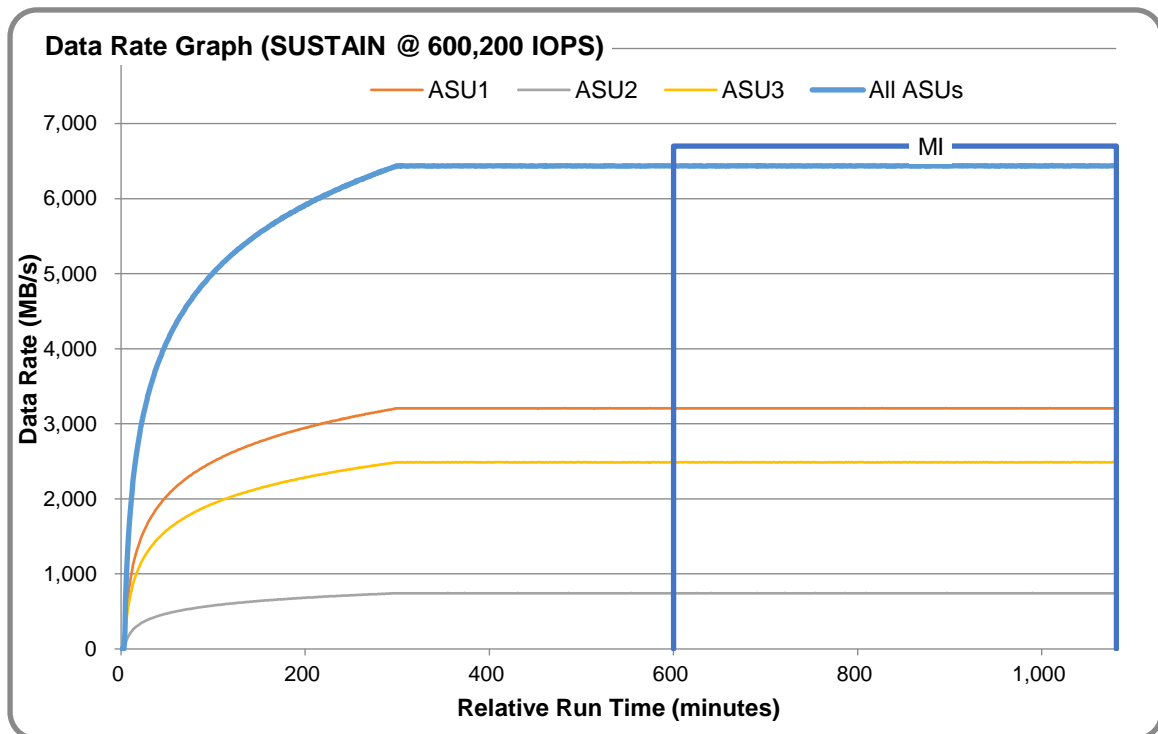

SUSTAIN – Response Time Frequency Graph

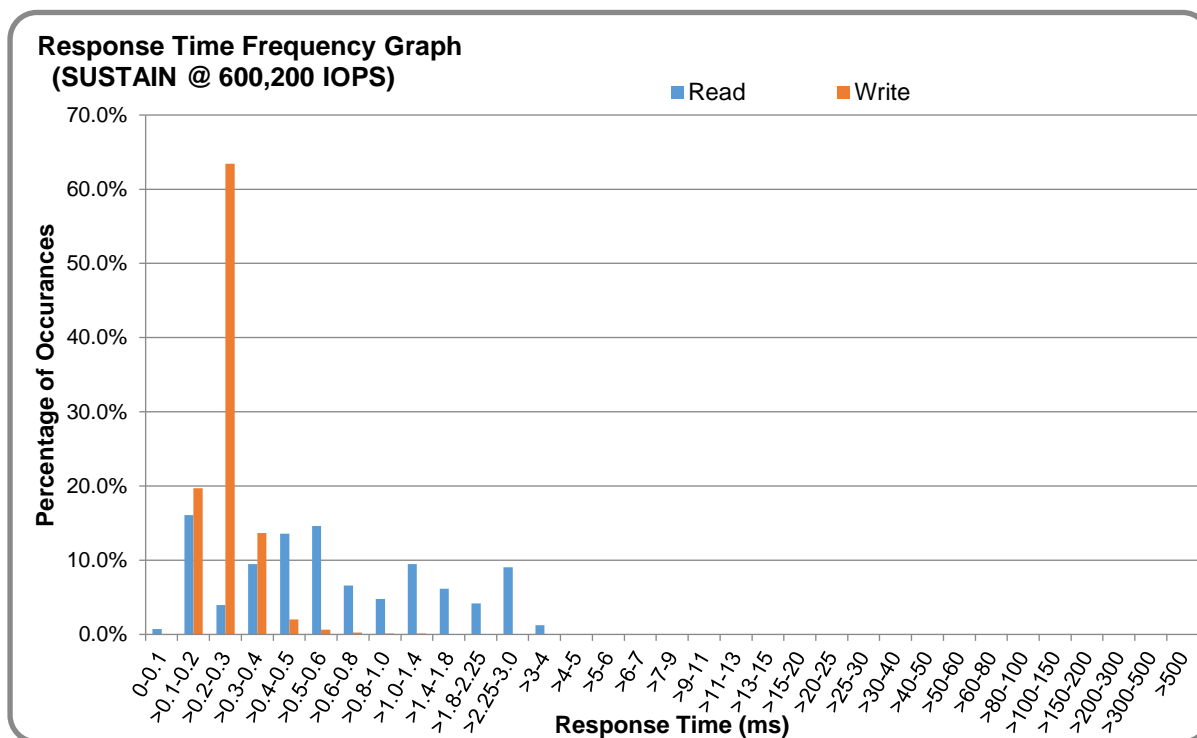

SUSTAIN – Intensity Multiplier

The following table lists the targeted intensity multiplier (Defined), the measured intensity multiplier (Measured) for each I/O STREAM, its coefficient of variation (Variation) and the percentage of difference (Difference) between Target and Measured.

	ASU1-1	ASU1-2	ASU1-3	ASU1-4	ASU2-1	ASU2-2	ASU2-3	ASU3-1
Defined	0.0350	0.2810	0.0700	0.2100	0.0180	0.0700	0.0350	0.2810
Measured	0.0350	0.2810	0.0700	0.2100	0.0180	0.0700	0.0350	0.2810
Variation	0.0009	0.0003	0.0006	0.0003	0.0013	0.0006	0.0009	0.0003
Difference	0.012%	0.002%	0.004%	0.000%	0.002%	0.003%	0.010%	0.002%

RAMPD_100 Test Phase

RAMPD 100 – Results File

The results file generated during the execution of the RAMPD_100 Test Phase is included in the Supporting Files (see Appendix A) as follows:

- SPC1_METRICS_0_Raw_Results.xlsx

RAMPD 100 – Execution Times

Interval	Start Time	End Time	Duration
Transition Period	30-Jun-18 06:30:11	30-Jun-18 06:33:11	0:03:00
Measurement Interval	30-Jun-18 06:33:11	30-Jun-18 06:43:12	0:10:01

RAMPD 100 – Throughput Graph

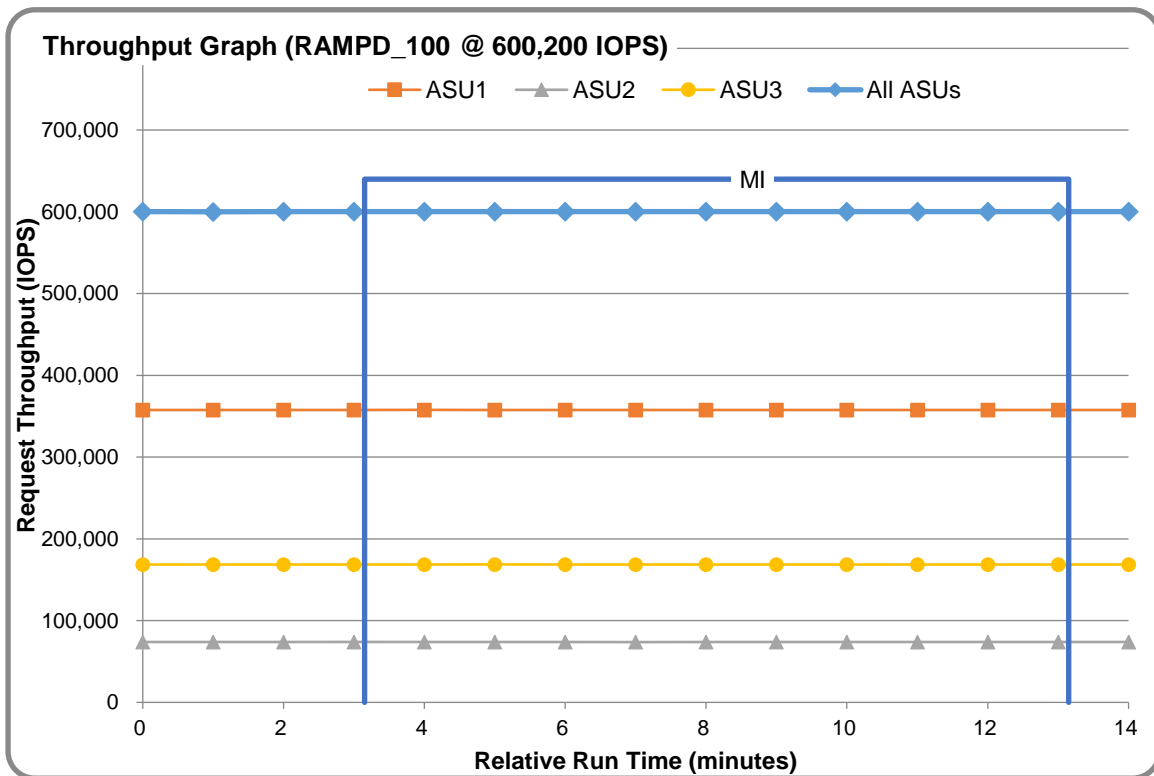

RAMPD 100 – Response Time Graph

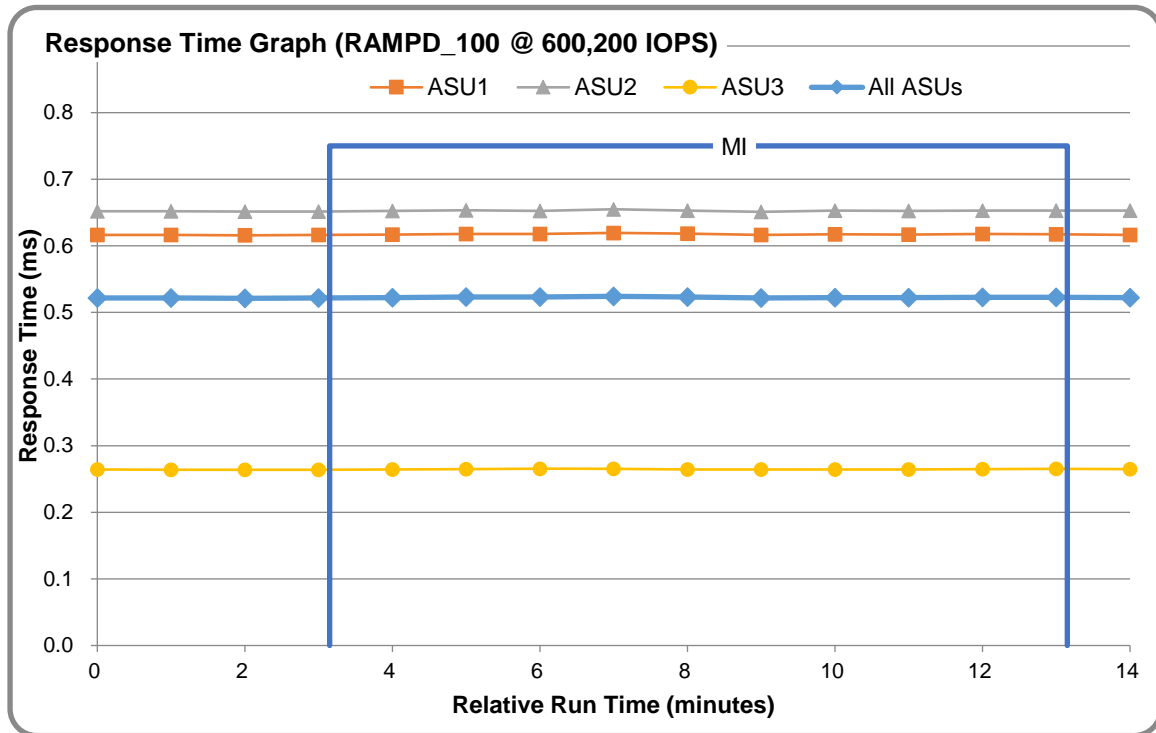

RAMPD 100 – Data Rate Graph

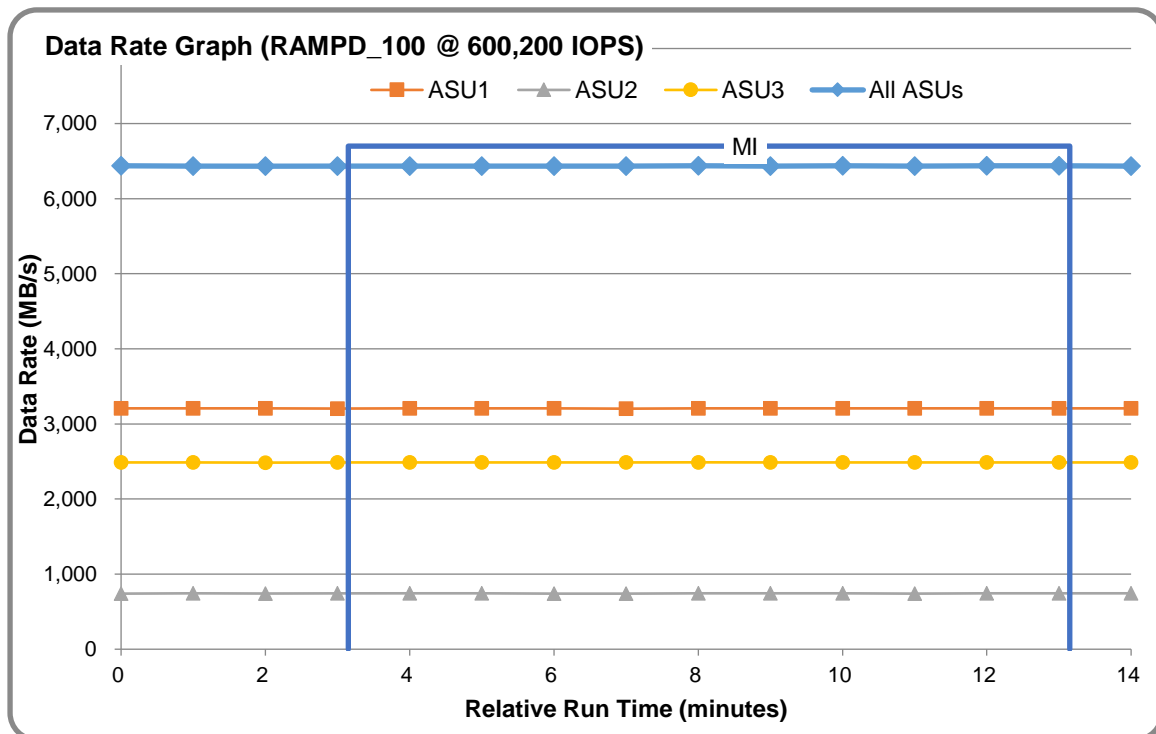

RAMPD 100 – Response Time Frequency Graph

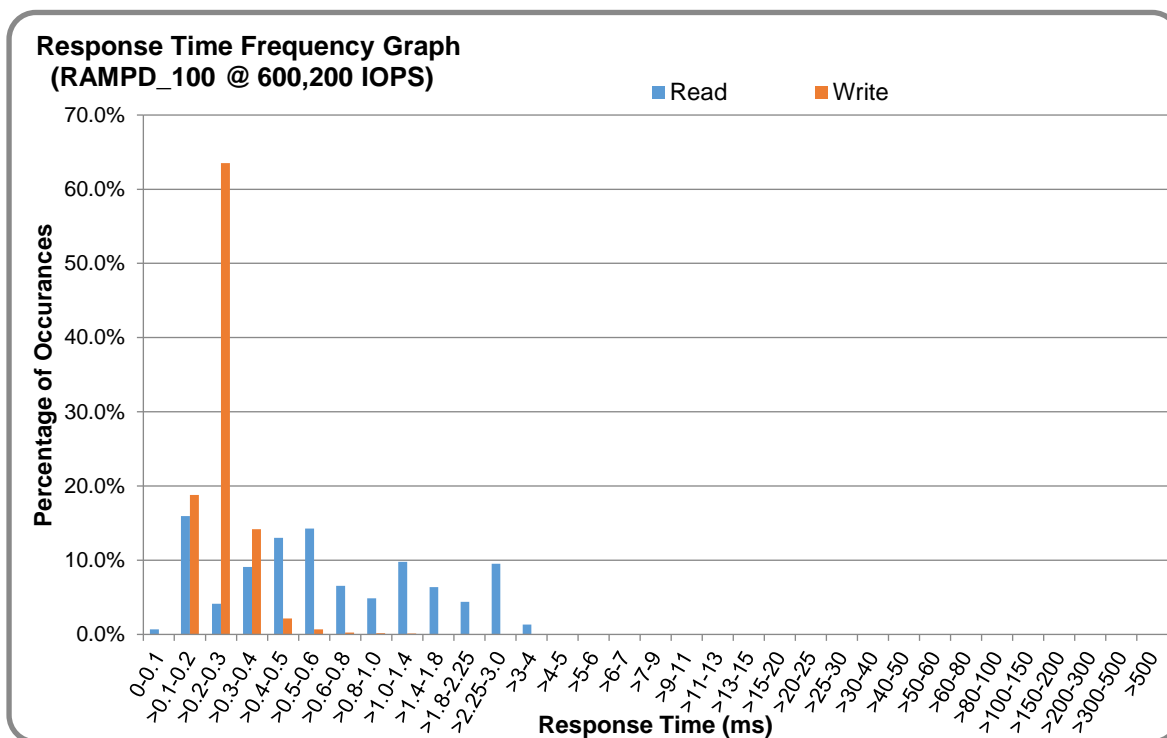

RAMPD 100 – Intensity Multiplier

The following table lists the targeted intensity multiplier (Defined), the measured intensity multiplier (Measured) for each I/O STREAM, its coefficient of variation (Variation) and the percentage of difference (Difference) between Target and Measured.

	ASU1-1	ASU1-2	ASU1-3	ASU1-4	ASU2-1	ASU2-2	ASU2-3	ASU3-1
Defined	0.0350	0.2810	0.0700	0.2100	0.0180	0.0700	0.0350	0.2810
Measured	0.0350	0.2810	0.0700	0.2100	0.0180	0.0700	0.0350	0.2810
Variation	0.0012	0.0002	0.0004	0.0004	0.0010	0.0006	0.0009	0.0003
Difference	0.046%	0.003%	0.012%	0.015%	0.005%	0.015%	0.043%	0.002%

RAMPD 100 – I/O Request Summary

I/O Requests Completed in the Measurement Interval	360,160,286
I/O Requests Completed with Response Time <= 30 ms	360,160,286
I/O Requests Completed with Response Time > 30 ms	0

Response Time Ramp Test

Response Time Ramp Test – Results File

The results file generated during the execution of the Response Time Ramp Test is included in the Supporting Files (see Appendix A) as follows:

- **SPC1_METRICS_0_Raw_Results.xlsx**

Response Time Ramp Test – Phases

The Response Time Ramp Test is comprised of 11 Test Phases, including six Ramp-Down Phases (executed at 100%, 95%, 90%, 80%, 50%, and 10% of the Business Scaling Unit) and five Ramp-Up Phases (executed at 50%, 80%, 90%, 95%, and 100% of the Business Scaling Unit).

Response Time Ramp Test – Average Throughput Graph

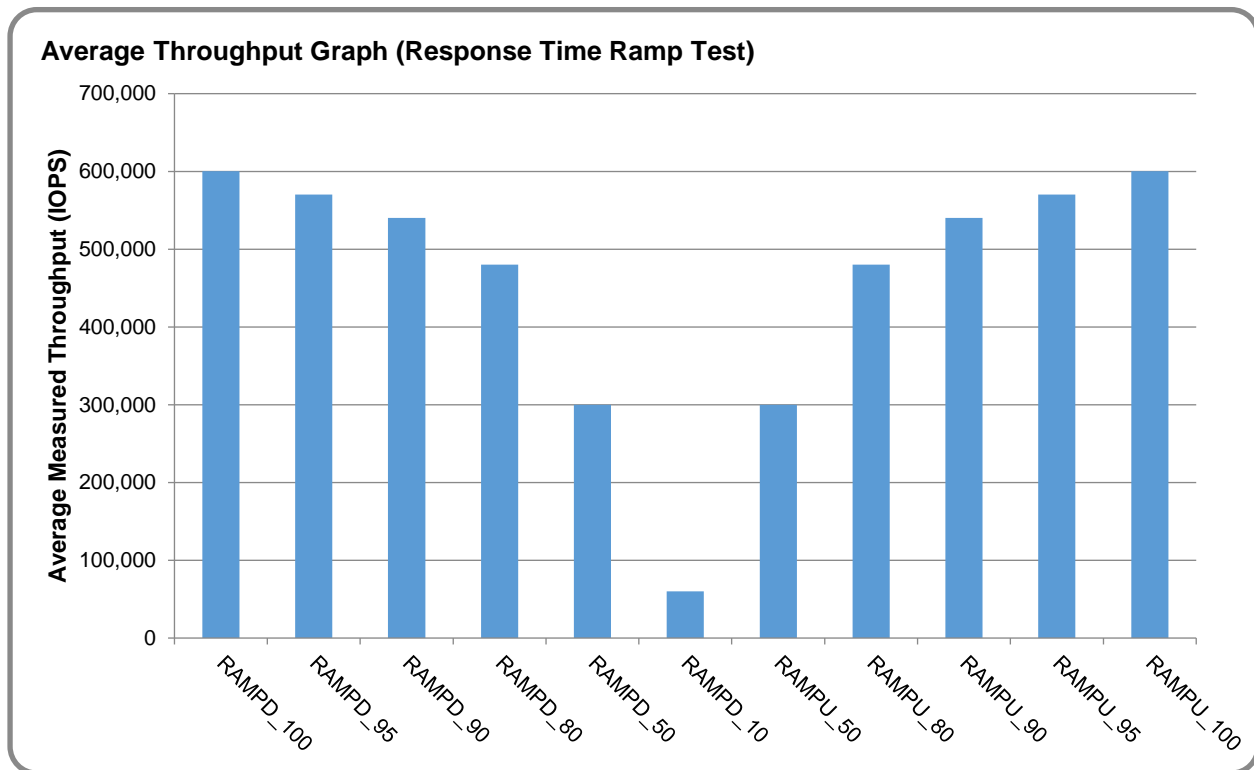

Response Time Ramp Test – Average Response Time Graph

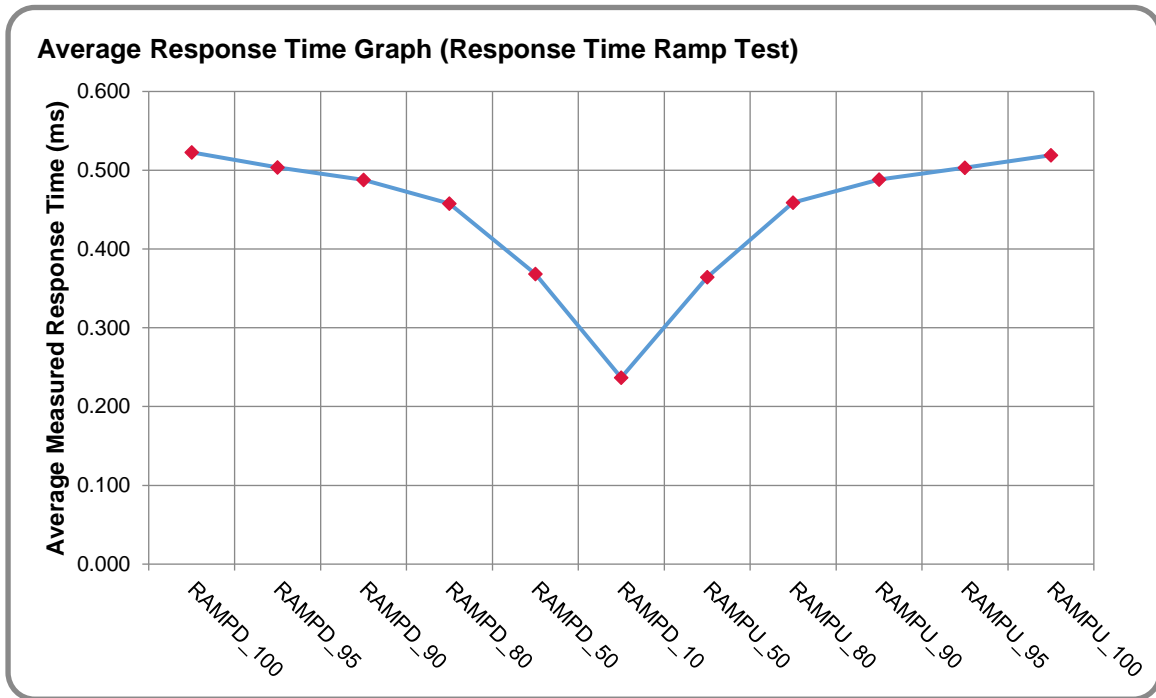

Response Time Ramp Test – RAMPD 10 Response Time Graph

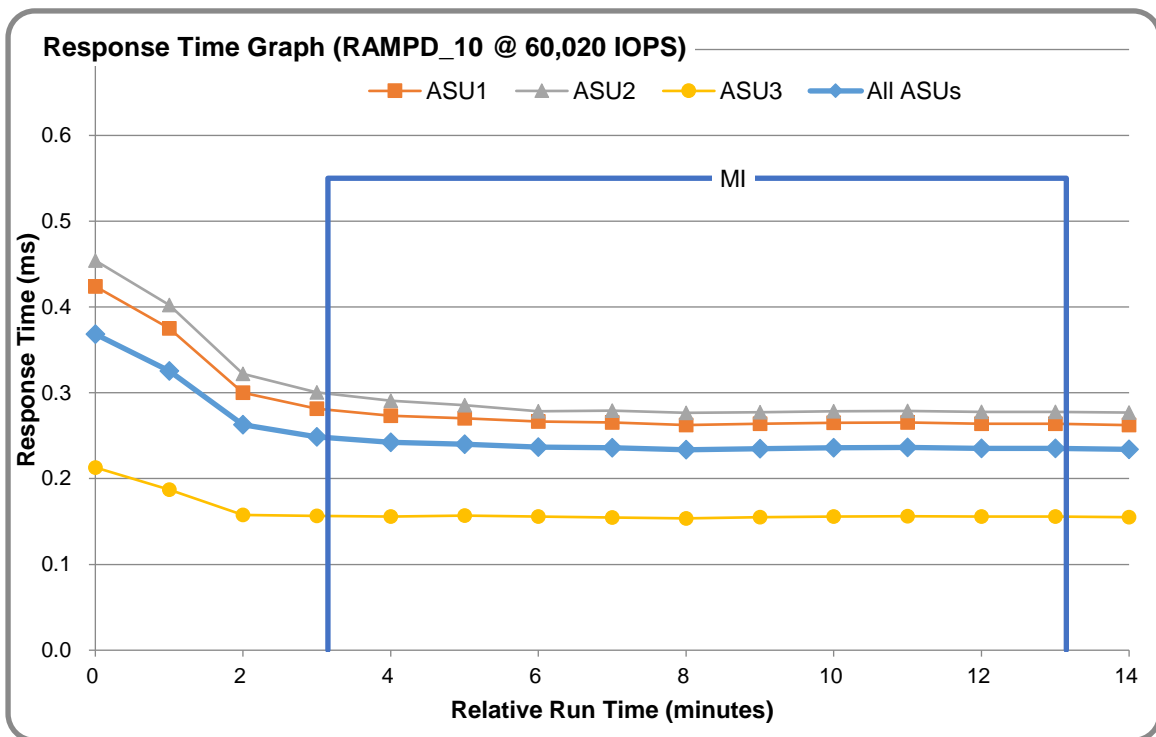

Repeatability Test

Repeatability Test Results File

The results file generated during the execution of the Repeatability Test is included in the Supporting Files (see Appendix A) as follows:

- SPC1_METRICS_0_Raw_Results.xlsx

Repeatability Test Results

The throughput measurements for the Response Time Ramp Test (RAMPD) and the Repeatability Test Phases (REPEAT_1 and REPEAT_2) are listed in the tables below.

Test Phase	100% IOPS	10% IOPS
RAMPD	600,275.3	60,012.7
REPEAT_1	600,240.1	60,023.1
REPEAT_2	600,165.2	60,019.2

REPEAT 1 100 – Throughput Graph

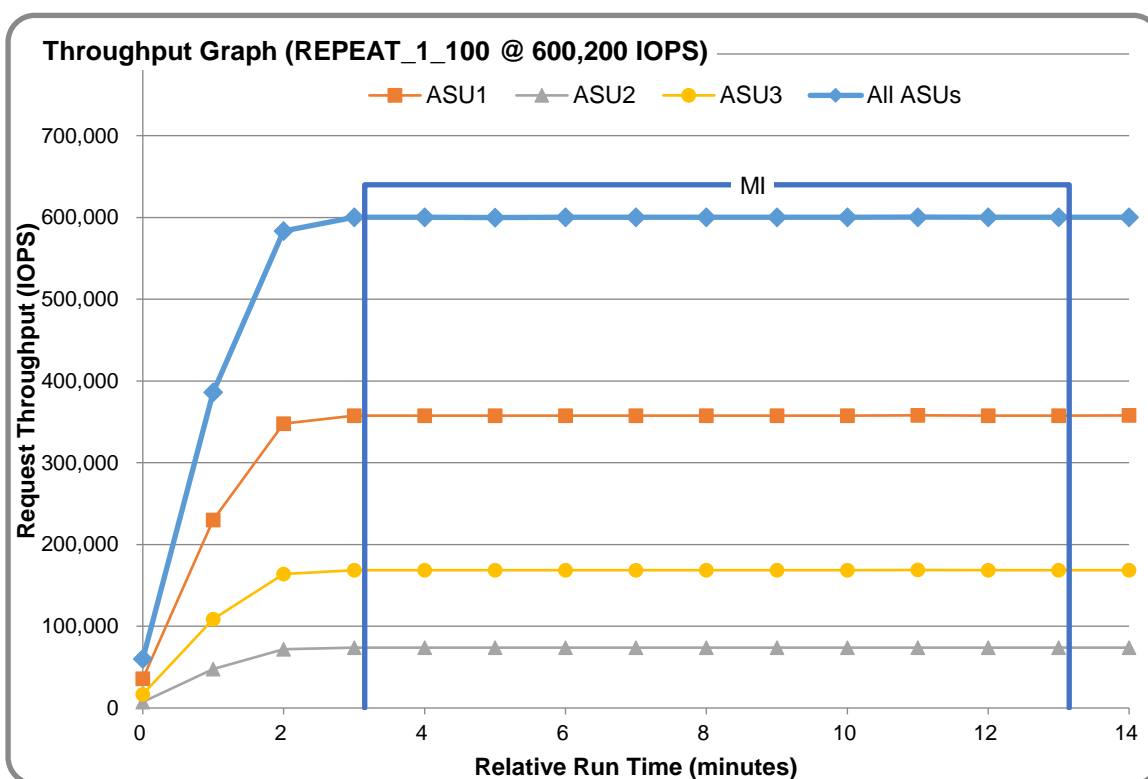

REPEAT 1 100 – Response Time Graph

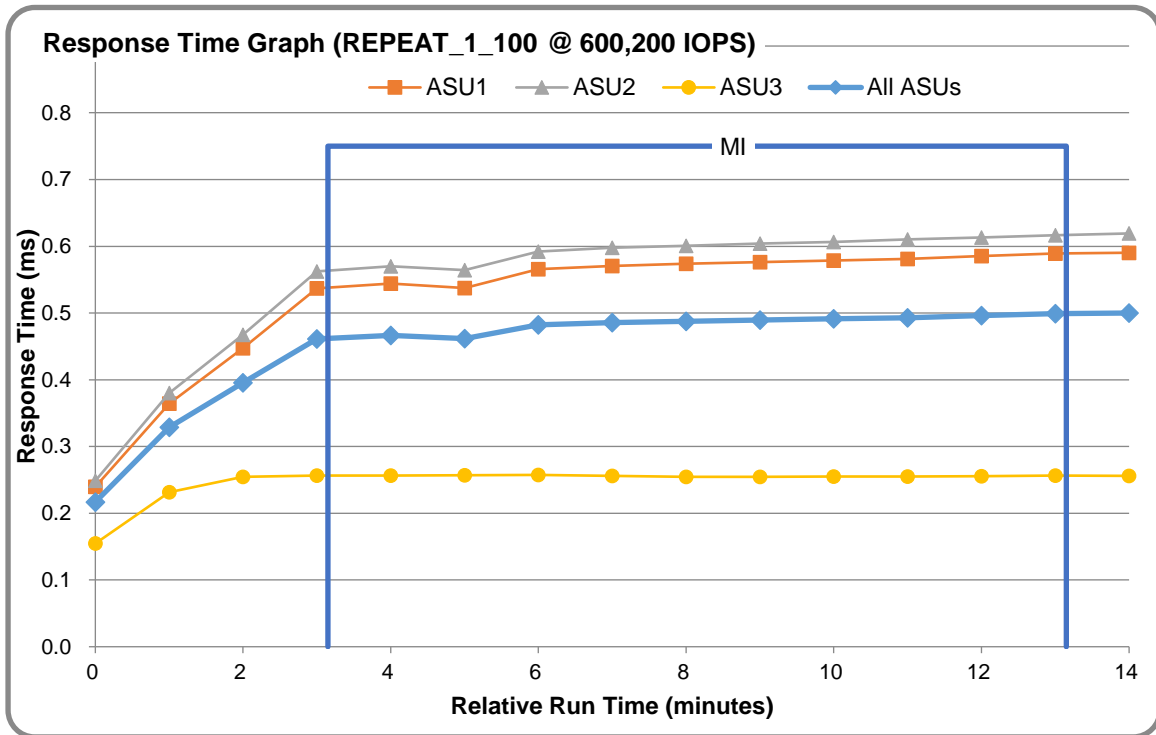

REPEAT 2 100 – Throughput Graph

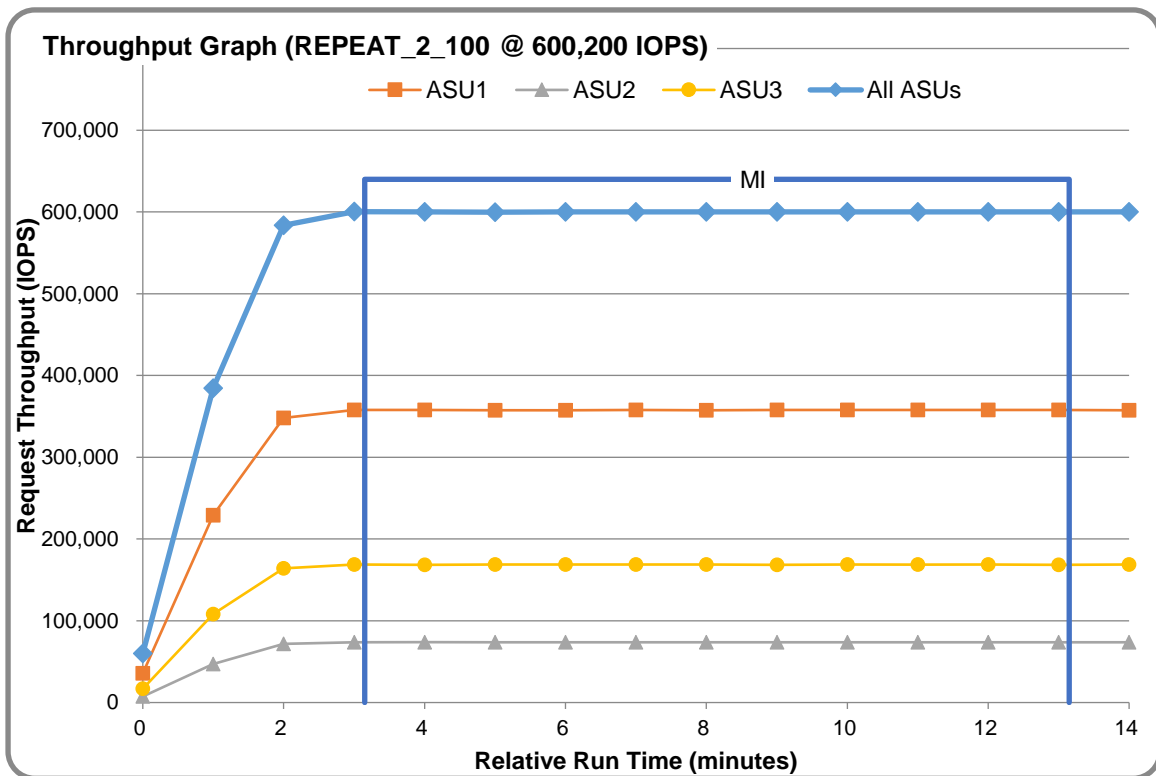

REPEAT 2 100 – Response Time Graph

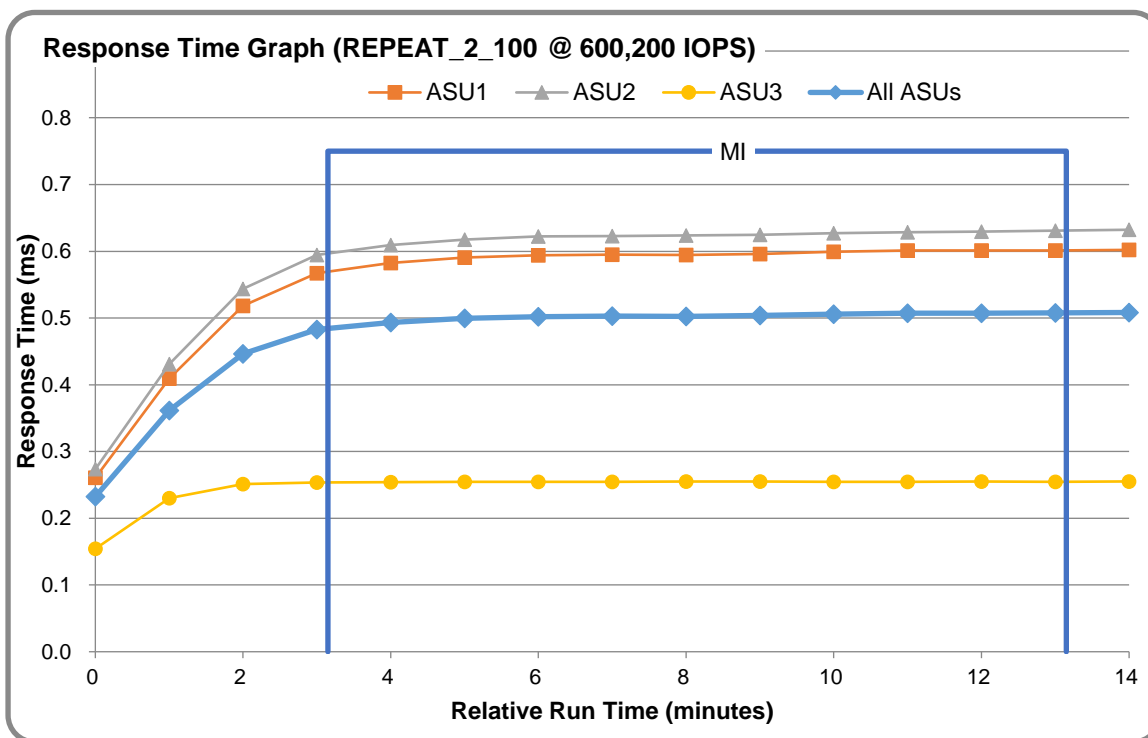

Repeatability Test – Intensity Multiplier

The following tables lists the targeted intensity multiplier (Defined), the measured intensity multiplier (Measured) for each I/O STREAM, its coefficient of variation (Variation) and the percent of difference (Difference) between Target and Measured.

REPEAT_1_100 Test Phase

	ASU1-1	ASU1-2	ASU1-3	ASU1-4	ASU2-1	ASU2-2	ASU2-3	ASU3-1
Defined	0.0350	0.2810	0.0700	0.2100	0.0180	0.0700	0.0350	0.2810
Measured	0.0350	0.2810	0.0700	0.2100	0.0180	0.0700	0.0350	0.2810
Variation	0.0009	0.0002	0.0005	0.0002	0.0008	0.0005	0.0009	0.0003
Difference	0.014%	0.011%	0.001%	0.004%	0.051%	0.008%	0.008%	0.006%

REPEAT_2_100 Test Phase

	ASU1-1	ASU1-2	ASU1-3	ASU1-4	ASU2-1	ASU2-2	ASU2-3	ASU3-1
Defined	0.0350	0.2810	0.0700	0.2100	0.0180	0.0700	0.0350	0.2810
Measured	0.0350	0.2810	0.0700	0.2100	0.0180	0.0700	0.0350	0.2810
Variation	0.0006	0.0003	0.0005	0.0002	0.0012	0.0004	0.0010	0.0003
Difference	0.011%	0.002%	0.004%	0.008%	0.021%	0.003%	0.043%	0.005%

Data Persistence Test

Data Persistence Test Results file

The results files generated during the execution of the Data Persistence Test is included in the Supporting Files (see Appendix A) as follows:

- **SPC1_PERSIST_1_0_Raw_Results.xlsx**
- **SPC1_PERSIST_2_0_Raw_Results.xlsx**

Data Persistence Test Execution

The Data Persistence Test was executed using the following sequence of steps:

- The PERSIST_1_0 Test Phase was executed to completion.
- The Benchmark Configuration was taken through an orderly shutdown process and powered off.
- The Benchmark Configuration was powered on and taken through an orderly startup process.
- The PERSIST_2_0 Test Phase was executed to completion.

Data Persistence Test Results

Data Persistence Test Phase: Persist1	
Total Number of Logical Blocks Written	123,285,725
Total Number of Logical Blocks Verified	68,665,991
Total Number of Logical Blocks Overwritten	54,619,734
Total Number of Logical Blocks that Failed Verification	0
Time Duration for Writing Test Logical Blocks (sec.)	601
Size in bytes of each Logical Block	8,192
Number of Failed I/O Requests in the process of the Test	0

Committed Data Persistence Implementation

The persistency of committed data is implemented at two levels. At the disk level, data loss is prevented through the use of RAID 10 arrays. At the controller level, all caches are mirrored across controllers, where write requests are only completed once the local cache has been successfully mirrored in another controller's cache. In addition, cache content is protected from a loss of power by flushing the cache content to permanent flash memory, as soon as a power loss is detected. The flushing action is powered by a battery backup located in each controller.

APPENDIX A: SUPPORTING FILES

The following table details the content of the Supporting Files provided as part of this Full Disclosure Report.

File Name	Description	Location
/SPC1_RESULTS	Data reduction worksheets	root
SPC1_INIT_0_Raw_Results.xlsx	Raw results for INIT Test Phase	/SPC1_RESULTS
SPC1_METRICS_0_Quick_Look.xlsx	Quick Look Test Run Overview	/SPC1_RESULTS
SPC1_METRICS_0_Raw_Results.xlsx	Raw results for Primary Metrics Test	/SPC1_RESULTS
SPC1_METRICS_0_Summary_Results.xlsx	Primary Metrics Summary	/SPC1_RESULTS
SPC1_PERSIST_1_0_Raw_Results.xlsx	Raw results for PERSIST1 Test Phase	/SPC1_RESULTS
SPC1_PERSIST_2_0_Raw_Results.xlsx	Raw results for PERSIST2 Test Phase	/SPC1_RESULTS
SPC1_Run_Set_Overview.xlsx	Run Set Overview Worksheet	/SPC1_RESULTS
SPC1_VERIFY_0_Raw_Results.xlsx	Raw results for first VERIFY Test Phase	/SPC1_RESULTS
SPC1_VERIFY_1_Raw_Results.xlsx	Raw results for second VERIFY Test Phase	/SPC1_RESULTS
/C_Tuning	Tuning parameters and options	root
aio-max-nr.sh	Set maximum asynchronous I/O	/C_Tuning
nr_requests.sh	Increase disk queue depth	/C_Tuning
scheduler.sh	Change the I/O scheduler	/C_Tuning
/D_Creation	Storage configuration creation	root
mklun.txt	Create the storage environment	/D_Creation
mkvolume.sh	Create the Logical Volumes	/D_Creation
/E_Inventory	Configuration inventory	root
shstorage.tcl	Captures profile of storage environment	/E_Inventory
profile1_volume.log	List of logical volumes before INIT	/E_Inventory
profile1_storage.log	List of storage devices before INIT	/E_Inventory
profile2_volume.log	List of logical volumes after restart	/E_Inventory
profile2_storage.log	List of storage devices after restart	/E_Inventory
/F_Generator	Workload generator	root
slave_asu.asu	Defining LUNs hosting the ASUs	/F_generator
4host.HST	Host configuration file	/F_generator
full_run.sh	Executing all test phases	/F_generator

APPENDIX B: THIRD PARTY QUOTATION



Address: 32 Broadway, Suite 401
New York, NY 10004
Tel: 212-809-6625
Email: sales@noviant.com

07/03/2018, Quote Valid:90 Days

No.	Model	Description	Qty.	Unit Price (USD)	Disc. (off)	Total Disc. Price
1	Phase					
1.1	Location					
1.1.1	OceanStor 5500 V5 Main Equipment					
1.1.1	Controller Enclosure					
	55V5-256G-2S-AC2-8FC	5500 V5(2U,Dual Ctrl,AC\240HVDC,256GB,SmartIO,8*8Gb FC,4 Port 4*12Gbps SAS,25*2.5",SPE34C0225)	2	85524	68%	54,735.36
1.1.2	Expanding Interface Module					
	SMARTIO10 ETH	4 port SmartIO I/O module(SFP+,10Gb Eth/FCoE(VN2V/F)/Scale-out)	4	6288	68%	8,048.64
1.1.3	Disk Components					
	HSSD-900G2S-A6	900GB SSD SAS Disk Unit(2.5")	48	9096	70%	130,982.40
1.1.4	Disk Enclosure					
	DAE52525U2-AC-A2	Disk Enclosure(2U,AC\240HVDC,2.5",Expanding Module,25 Disk Slots,without Disk Unit,DAE52525U2)	4	10584	68%	13,547.52
1.1.5	HBA					
	N8GHBA000	QLOGIC QLE2562 HBA Card,PCIE,8Gbps DualPort ,Fiber Channel Multimode LC Optic Interface,English Manual, No Drive CD	8	1698	0%	13,584.00
1.1.6	Accessory					
	SN2F01FCPC	Patch Cord,DLC/PC,DLC/PC,Multi-mode,3m,A1a,2.2mm,42mm DLC,OM3 bending insensitive	24	14	0%	336.00
1.1.7	Storage Software					
	LIC-55V5-BS	Basic Software License for Block (Including Device Manager,SmartThin,SmartMulti-tenant,SmartMigration,SmartErase,SmartMotion, UltraPath and SystemReporter)	1	8676	70%	2,602.80
Total of Product						223,836.72
1.1.8	Maintenance Support Service					

02351QJY-88134ULF-36	5500 V5(2U,Dual Ctrl,AC\240HVDC,256GB,SmartIO,8*8Gb FC,4 Port 4*12Gbps SAS,25*2.5",SPE34C0225&2"Disk Enclosure-2U,AC\240HVDC,2.5",DAE52525U2&24*900GB SSD SAS Disk Unit(2.5"))-Hi-Care Onsite Premier 24x7x4H Engineer Onsite Service-36Month(s)	2	15156	0%	30,312.00
88034JUH-88134UHK-36	Basic Software License for Block (Including Device Manager,SmartThin,SmartMulti-tenant,SmartMigration,SmartErase,SmartMotion, UltraPath and SystemReporter)-Hi-Care Application Software Upgrade Support Service-36Month(s)	1	2085	0%	2,085.00
8812153244	OceanStor 5500 V5 Installation Service - Engineering	1	13045	0%	13,045.00
Total of Service (3 years)					45,442.00
Total Price					269,278.72
Notes:Hi-Care Premier On-Site Service include: 7*24 Technical Assistance Center Access. Access to all new software updates and Online Support. 24*7*4 Hours Onsite Hardware Replacement.					
Payment Terms:					
Comments:					
Noviant is an Authorized Value Added reseller (VAR) of networking products. Products sold by NF are factory new unless otherwise specified. All new products sold by NF carry its own Original Equipment Manufacturer's (OEM) Limited Warranty and software licenses. This Quote is valid for 90 days. Prices and availability is subject to change without notice. Installation and configuration costs are not included in the quoted pricing unless specified. A 20% Restocking Fee applies to all cancelled orders and/or returned products. Special Orders are non-returnable. Buyer is responsible for payment of all applicable taxes and freight charges. Issuance of customer PO against this Quote constitutes acceptance of Noviant Sales Terms conditions.					
I agree to the these terms and conditions.					
Authorized Acceptance: _____ Print Name: _____ Date: _____					
Noviant: _____ Print Name: _____ Date: _____					

APPENDIX C: TUNING PARAMETERS AND OPTIONS

The following scripts, listed below, were used to set tuning parameters and options:

- ***aio-max-nr.sh*** to change the maximum number of AIO operations to 1048576
- ***nr_requests.sh*** to change `nr_requests` from 128 to 1024 on each Host System for each device
- ***scheduler.sh*** to change the I/O scheduler from `cfq` to `noop` on each Host System, which will result in all incoming I/O requests inserted into a simple, unordered FIFO queue

The scripts described above are included in the Supporting Files (see Appendix A) and listed below.

aio-max-nr.sh

```
echo 1048576 > /proc/sys/fs/aio-max-nr
```

nr_requests.sh

```
echo 2048 >/sys/block/sdb/queue/nr_requests
echo 2048 >/sys/block/sdc/queue/nr_requests
echo 2048 >/sys/block/sdd/queue/nr_requests
echo 2048 >/sys/block/sde/queue/nr_requests
echo 2048 >/sys/block/sdf/queue/nr_requests
echo 2048 >/sys/block/sdg/queue/nr_requests
echo 2048 >/sys/block/sdh/queue/nr_requests
echo 2048 >/sys/block/sdi/queue/nr_requests
echo 2048 >/sys/block/sdj/queue/nr_requests
echo 2048 >/sys/block/sdk/queue/nr_requests
echo 2048 >/sys/block/sdl/queue/nr_requests
echo 2048 >/sys/block/sdm/queue/nr_requests
echo 2048 >/sys/block/sdn/queue/nr_requests
echo 2048 >/sys/block/sdo/queue/nr_requests
echo 2048 >/sys/block/sdp/queue/nr_requests
echo 2048 >/sys/block/sdq/queue/nr_requests
echo 2048 >/sys/block/sdr/queue/nr_requests
echo 2048 >/sys/block/sds/queue/nr_requests
echo 2048 >/sys/block/sdt/queue/nr_requests
echo 2048 >/sys/block/sdu/queue/nr_requests
echo 2048 >/sys/block/sdv/queue/nr_requests
echo 2048 >/sys/block/sdw/queue/nr_requests
echo 2048 >/sys/block/sdx/queue/nr_requests
echo 2048 >/sys/block/sdy/queue/nr_requests
```

- ***scheduler.sh***

```
echo noop >/sys/block/sdb/queue/scheduler
echo noop >/sys/block/sdc/queue/scheduler
echo noop >/sys/block/sdd/queue/scheduler
echo noop >/sys/block/sde/queue/scheduler
echo noop >/sys/block/sdf/queue/scheduler
echo noop >/sys/block/sdg/queue/scheduler
```



```
echo noop >/sys/block/sdh/queue/scheduler
echo noop >/sys/block/sdi/queue/scheduler
echo noop >/sys/block/sdj/queue/scheduler
echo noop >/sys/block/sdk/queue/scheduler
echo noop >/sys/block/sdl/queue/scheduler
echo noop >/sys/block/sdm/queue/scheduler
echo noop >/sys/block/sdn/queue/scheduler
echo noop >/sys/block/sdo/queue/scheduler
echo noop >/sys/block/sdp/queue/scheduler
echo noop >/sys/block/sdq/queue/scheduler
echo noop >/sys/block/sdr/queue/scheduler
echo noop >/sys/block/sds/queue/scheduler
echo noop >/sys/block/sdt/queue/scheduler
echo noop >/sys/block/sdu/queue/scheduler
echo noop >/sys/block/sdv/queue/scheduler
echo noop >/sys/block/sdw/queue/scheduler
echo noop >/sys/block/sdx/queue/scheduler
echo noop >/sys/block/sdy/queue/scheduler
```

APPENDIX D: STORAGE CONFIGURATION CREATION

Environment

First, the CLI commands from the following command file are copied and pasted into the OceanStor 5500 V5 CLI window. These commands are executed on one of the Host Systems.

- ***mk lun.txt***

Next, the following shell script is executed on one of the Host Systems.

- ***mk volume.sh***

Step 1 - Create Disk Domains, Storage Pools, LUNs

The ***mk lun.txt*** command file, listed below, includes all the CLI commands to perform the following actions:

- Create 6 disk domains
- Create 6 storage pools
- Create 24 LUNs
- Create one LUN group
- Add the 24 LUNs to the LUN group

The command file described above is included in the Supporting Files (see Appendix A) and listed below.

mk lun.txt

```
create disk_domain name=dd00 disk_list=CTE0.0-7 tier0_hotspare_strategy=low
  disk_domain_id=0
create disk_domain name=dd01 disk_list=DAE010.0-7 tier0_hotspare_strategy=low
  disk_domain_id=1
create disk_domain name=dd02 disk_list=CTE1.0-7 tier0_hotspare_strategy=low
  disk_domain_id=2
create disk_domain name=dd03 disk_list=DAE110.0-7 tier0_hotspare_strategy=low
  disk_domain_id=3
create disk_domain name=dd04 disk_list=DAE120.0-7 tier0_hotspare_strategy=low
  disk_domain_id=4
create disk_domain name=dd05 disk_list=DAE020.0-7 tier0_hotspare_strategy=low
  disk_domain_id=5

create storage_pool name=sp00 disk_type=SSD capacity=2744GB raid_level=RAID10
  pool_id=0 disk_domain_id=0
create storage_pool name=sp01 disk_type=SSD capacity=2744GB raid_level=RAID10
  pool_id=1 disk_domain_id=1
create storage_pool name=sp02 disk_type=SSD capacity=2744GB raid_level=RAID10
  pool_id=2 disk_domain_id=2
create storage_pool name=sp03 disk_type=SSD capacity=2744GB raid_level=RAID10
  pool_id=3 disk_domain_id=3
create storage_pool name=sp04 disk_type=SSD capacity=2744GB raid_level=RAID10
  pool_id=4 disk_domain_id=4
create storage_pool name=sp05 disk_type=SSD capacity=2744GB raid_level=RAID10
  pool_id=5 disk_domain_id=5
```

```
create lun name=lun_sp00 lun_id_list=0-3 pool_id=0 capacity=685GB
create lun name=lun_sp01 lun_id_list=4-7 pool_id=1 capacity=685GB
create lun name=lun_sp02 lun_id_list=8-11 pool_id=2 capacity=685GB
create lun name=lun_sp03 lun_id_list=12-15 pool_id=3 capacity=685GB
create lun name=lun_sp04 lun_id_list=16-19 pool_id=4 capacity=685GB
create lun name=lun_sp05 lun_id_list=20-23 pool_id=5 capacity=685GB

create host name=host0 operating_system=Linux host_id=0
create host name=host1 operating_system=Linux host_id=1
create host name=host2 operating_system=Linux host_id=2
create host name=host3 operating_system=Linux host_id=3
```

Step 2 - Create Mapping View, Host Group and Host

The ***mk lun.txt*** command file, listed below, includes all the CLI commands to perform the following actions:

- Create 4 hosts
- Create a host group
- Create a mapping view
- Add the 4 hosts to the host group
- Add the host group and the LUN group to the mapping view
- Add the FC port's WWN to the 4 hosts

The command file described above is included in the Supporting Files (see Appendix A) and listed below.

mk lun.txt

```
create host_group name=hg0 host_group_id=0 host_id_list=0-3
create lun_group name=lg0 lun_group_id=0
add lun_group lun lun_group_id=0 lun_id_list=0-23
create mapping_view name=mv1 mapping_view_id=1 lun_group_id=0 host_group_id=0

add host initiator host_id=0 initiator_type=FC wwn=21000024ff7fb903
add host initiator host_id=0 initiator_type=FC wwn=21000024ff7fb716
add host initiator host_id=0 initiator_type=FC wwn=21000024ff7fb717
add host initiator host_id=0 initiator_type=FC wwn=21000024ff7fb902

add host initiator host_id=1 initiator_type=FC wwn=21000024ff17e0bb
add host initiator host_id=1 initiator_type=FC wwn=2100000e1e1c2600
add host initiator host_id=1 initiator_type=FC wwn=2100000e1e1c2601
add host initiator host_id=1 initiator_type=FC wwn=21000024ff17e0ba

add host initiator host_id=2 initiator_type=FC wwn=21000024ff17dff5
add host initiator host_id=2 initiator_type=FC wwn=21000024ff17df38
add host initiator host_id=2 initiator_type=FC wwn=21000024ff17df39
add host initiator host_id=2 initiator_type=FC wwn=21000024ff17dff4

add host initiator host_id=3 initiator_type=FC wwn=21000024ff7f431a
add host initiator host_id=3 initiator_type=FC wwn=21000024ff7f431b
add host initiator host_id=3 initiator_type=FC wwn=21000024ff7f78fe
add host initiator host_id=3 initiator_type=FC wwn=21000024ff7f78ff
```

Step 3 - Create Volumes on the Master Host Systems

The ***mkvolume.sh*** shell script, listed below, is invoked on the master Host Systems to perform the following actions:

- Create 24 physical volumes
- Create a volume group for the 64 physical volumes
- Create 18 Logical Volumes for ASU-1
- Create 18 Logical Volumes for ASU-2
- Create 2 Logical Volumes for ASU-3

The shell script described above is included in the Supporting Files (see Appendix A) and listed below.

mkvolume.sh

```
pvcreate /dev/sdb
pvcreate /dev/sdc
pvcreate /dev/sdd
pvcreate /dev/sde
pvcreate /dev/sdf
pvcreate /dev/sdg
pvcreate /dev/sdh
pvcreate /dev/sdi
pvcreate /dev/sdj
pvcreate /dev/sdk
pvcreate /dev/sdl
pvcreate /dev/sdm
pvcreate /dev/sdn
pvcreate /dev/sdo
pvcreate /dev/sdp
pvcreate /dev/sdq
pvcreate /dev/sdr
pvcreate /dev/sds
pvcreate /dev/sdt
pvcreate /dev/sdu
pvcreate /dev/sdv
pvcreate /dev/sdw
pvcreate /dev/sdx
pvcreate /dev/sdy

vgcreate vg1 /dev/sdb /dev/sdc /dev/sdd /dev/sde /dev/sdf /dev/sdg /dev/sdh
/dev/sdi /dev/sdj /dev/sdk /dev/sdl /dev/sdm /dev/sdn /dev/sdo /dev/sdp
/dev/sdq /dev/sdr /dev/sds /dev/sdt /dev/sdu /dev/sdv /dev/sdw /dev/sdx
/dev/sdy

lvcreate -n asu101 -i 24 -I 512 -C y -L 405g vg1
lvcreate -n asu102 -i 24 -I 512 -C y -L 405g vg1
lvcreate -n asu103 -i 24 -I 512 -C y -L 405g vg1
lvcreate -n asu104 -i 24 -I 512 -C y -L 405g vg1
lvcreate -n asu105 -i 24 -I 512 -C y -L 405g vg1
lvcreate -n asu106 -i 24 -I 512 -C y -L 405g vg1
lvcreate -n asu107 -i 24 -I 512 -C y -L 405g vg1
lvcreate -n asu108 -i 24 -I 512 -C y -L 405g vg1
lvcreate -n asu109 -i 24 -I 512 -C y -L 405g vg1
lvcreate -n asu110 -i 24 -I 512 -C y -L 405g vg1
lvcreate -n asu111 -i 24 -I 512 -C y -L 405g vg1
lvcreate -n asu112 -i 24 -I 512 -C y -L 405g vg1
```

```
lvcreate -n asu113 -i 24 -I 512 -C y -L 405g vg1
lvcreate -n asu114 -i 24 -I 512 -C y -L 405g vg1
lvcreate -n asu115 -i 24 -I 512 -C y -L 405g vg1
lvcreate -n asu116 -i 24 -I 512 -C y -L 405g vg1
lvcreate -n asu117 -i 24 -I 512 -C y -L 405g vg1
lvcreate -n asu118 -i 24 -I 512 -C y -L 405g vg1

lvcreate -n asu201 -i 24 -I 512 -C y -L 405g vg1
lvcreate -n asu202 -i 24 -I 512 -C y -L 405g vg1
lvcreate -n asu203 -i 24 -I 512 -C y -L 405g vg1
lvcreate -n asu204 -i 24 -I 512 -C y -L 405g vg1
lvcreate -n asu205 -i 24 -I 512 -C y -L 405g vg1
lvcreate -n asu206 -i 24 -I 512 -C y -L 405g vg1
lvcreate -n asu207 -i 24 -I 512 -C y -L 405g vg1
lvcreate -n asu208 -i 24 -I 512 -C y -L 405g vg1
lvcreate -n asu209 -i 24 -I 512 -C y -L 405g vg1
lvcreate -n asu210 -i 24 -I 512 -C y -L 405g vg1
lvcreate -n asu211 -i 24 -I 512 -C y -L 405g vg1
lvcreate -n asu212 -i 24 -I 512 -C y -L 405g vg1
lvcreate -n asu213 -i 24 -I 512 -C y -L 405g vg1
lvcreate -n asu214 -i 24 -I 512 -C y -L 405g vg1
lvcreate -n asu215 -i 24 -I 512 -C y -L 405g vg1
lvcreate -n asu216 -i 24 -I 512 -C y -L 405g vg1
lvcreate -n asu217 -i 24 -I 512 -C y -L 405g vg1
lvcreate -n asu218 -i 24 -I 512 -C y -L 405g vg1

lvcreate -n asu301 -i 24 -I 512 -C y -L 810g vg1
lvcreate -n asu302 -i 24 -I 512 -C y -L 810g vg1
```

APPENDIX E: CONFIGURATION INVENTORY

An inventory of the Tested Storage Configuration was collected during the execution the script *full_run.sh*. It generated the following log file:

- ***profile1_volume.log*** List of configured volumes before the INIT Phase.
- ***profile1_storage.log*** List of configured storage before the INIT Phase.
- ***Profile2_volume.log*** List of configured volumes after TSC restart.
- ***Profile2_storage.log*** List of configured storage after TSC restart.

The above log files are included in the Supporting Files (see Appendix A).

APPENDIX F: WORKLOAD GENERATOR

The ASUs accessed by the SPC-1 workload generator, are defined using the script ***slave_asu.asu***.

The phases of the benchmark are executed using the script ***full_run.sh***. The script pauses at the end of the PERSIST_1 test phase. Once the TSC has been restarted, the PERSIST_2 test phase is executed by pressing ENTER from the console where the script has been invoked.

The above scripts are included in the Supporting Files (see Appendix A) and listed below.

slave_asu.asu

```
ASU=1
OFFSET=0
SIZE=0
DEVICE=/dev/vg1/asu101
DEVICE=/dev/vg1/asu102
DEVICE=/dev/vg1/asu103
DEVICE=/dev/vg1/asu104
DEVICE=/dev/vg1/asu105
DEVICE=/dev/vg1/asu106
DEVICE=/dev/vg1/asu107
DEVICE=/dev/vg1/asu108
DEVICE=/dev/vg1/asu109
DEVICE=/dev/vg1/asu110
DEVICE=/dev/vg1/asu111
DEVICE=/dev/vg1/asu112
DEVICE=/dev/vg1/asu113
DEVICE=/dev/vg1/asu114
DEVICE=/dev/vg1/asu115
DEVICE=/dev/vg1/asu116
DEVICE=/dev/vg1/asu117
DEVICE=/dev/vg1/asu118
```

```
--
ASU=2
OFFSET=0
SIZE=0
DEVICE=/dev/vg1/asu201
DEVICE=/dev/vg1/asu202
DEVICE=/dev/vg1/asu203
DEVICE=/dev/vg1/asu204
DEVICE=/dev/vg1/asu205
DEVICE=/dev/vg1/asu206
DEVICE=/dev/vg1/asu207
DEVICE=/dev/vg1/asu208
DEVICE=/dev/vg1/asu209
DEVICE=/dev/vg1/asu210
DEVICE=/dev/vg1/asu211
DEVICE=/dev/vg1/asu212
DEVICE=/dev/vg1/asu213
DEVICE=/dev/vg1/asu214
DEVICE=/dev/vg1/asu215
DEVICE=/dev/vg1/asu216
```

```
DEVICE=/dev/vg1/asu217
DEVICE=/dev/vg1/asu218
--
ASU=3
OFFSET=0
SIZE=0
DEVICE=/dev/vg1/asu301
DEVICE=/dev/vg1/asu302
```

full_run.sh

```
#!/bin/sh
expect shstorage.tcl > profile1_storage.log
date > profile1_volume.log
lvdisplay >> profile1_volume.log
date >> profile1_volume.log

spc1 -run SPC1_INIT -iops 6000 -storage slave_asu.asu -output
./newtool/spc1_INIT_6k_iops -master 4host.HST
spc1 -run SPC1_VERIFY -iops 1000 -storage slave_asu.asu -output
./newtool/spc1_VERIFY1_1000_iops -master 4host.HST
spc1 -run SPC1_METRICS -iops 600200 -storage slave_asu.asu -output
./newtool/spc1_METRICS_600k_iops -master 4host.HST
spc1 -run SPC1_VERIFY -iops 1000 -storage slave_asu.asu -output
./newtool/spc1_VERIFY2_1000_iops -master 4host.HST
spc1 -run SPC1_PERSIST_1 -iops 150000 -storage slave_asu.asu -output
./newtool/spc1_PERSIST_150k_iops -master 4host.HST
echo "Power cycle TSC, then Enter to continue"
read

expect shstorage.tcl > profile2_storage.log
date > profile2_volume.log
lvdisplay >> profile2_volume.log
date >> profile2_volume.log
spc1 -run SPC1_PERSIST_2 -iops 150000 -storage slave_asu.asu -output
./newtool/spc1_PERSIST_150k_iops -master 4host.HST
```