



SPC BENCHMARK 1™

FULL DISCLOSURE REPORT

**HUAWEI TECHNOLOGIES CO., LTD
HUAWEI OCEANSTOR 18500 V5**

SPC-1 V3.6

SUBMISSION IDENTIFIER: A31013

SUBMITTED FOR REVIEW: MAY 28 2018

First Edition – May 2018

THE INFORMATION CONTAINED IN THIS DOCUMENT IS DISTRIBUTED ON AN AS IS BASIS WITHOUT ANY WARRANTY EITHER EXPRESS OR IMPLIED. The use of this information or the implementation of any of these techniques is the customer's responsibility and depends on the customer's ability to evaluate and integrate them into the customer's operational environment. While each item has been reviewed by Huawei. for accuracy in a specific situation, there is no guarantee that the same or similar results will be obtained elsewhere. Customers attempting to adapt these techniques to their own environment do so at their own risk.

This publication was produced in the United States. Huawei may not offer the products, services, or features discussed in this document in other countries, and the information is subject to change with notice. Consult your local Huawei representative for information on products and services available in your area.

© Copyright Huawei 2018. All rights reserved.

Permission is hereby granted to publicly disclose and reproduce this document, in whole or in part, provided the copyright notice as printed above is set forth in full text on the title page of each item reproduced.

Trademarks

SPC Benchmark 1, SPC-1, SPC-1 IOPS, SPC-1 LRT and SPC-1 Price-Performance are trademarks of the Storage Performance Council.

Huawei, the Huawei logo, FusionServer™ and OceanStor are trademarks or registered trademarks of Huawei in the United States and other countries. All other brands, trademarks, and product names are the property of their respective owners.

Benchmark Specification and Glossary

The official SPC Benchmark 1™ (SPC-1™) specification is available on the website of the Storage Performance Council (SPC) at www.storageperformance.org.

The SPC-1™ specification contains a glossary of the SPC-1™ terms used in this publication.

Table of Contents

Audit Certification..... 4

Letter Of Good Faith 6

Executive Summary 7

Configuration Information 13

Benchmark Configuration and Tested Storage Configuration..... 13

Benchmark Configuration Creation Process 15

Benchmark Execution Results..... 16

Benchmark Execution Overview 16

SUSTAIN Test Phase..... 17

RAMPD_100 Test Phase..... 20

Response Time Ramp Test..... 23

Repeatability Test 25

Data Persistence Test 28

Appendix A: Supporting Files 29

Appendix B: Third Party Quotation 30

Appendix C: Tuning Parameters and Options 33

Appendix D: Storage Configuration Creation 36

Appendix E: Configuration Inventory..... 43

Appendix F: Workload Generator 44

AUDIT CERTIFICATION



InfoSizing
The Right Metric For Sizing IT



Storage Performance Council
Certified Auditor

Zhong Xu
 Huawei Technologies Co., Ltd.
 Huawei Industrial Base, Bantian,
 Longgang, Shenzhen city,
 Guangdong province, China

May 26, 2018

I verified the SPC Benchmark 1™ (SPC-1™ Revision 3.6) test execution and performance results of the following Tested Storage Product:

HUAWEI OCEANSTOR 18500 V5

The results were:

SPC-1 IOPS™	4,800,419
SPC-1 Price-Performance™	\$400.96/SPC-1 KIOPS™
SPC-1 IOPS™ Response Time	0.821 ms
SPC-1 Overall Response Time	0.513 ms
SPC-1 ASU Capacity	109,093 GB
SPC-1 ASU Price	\$17.65/GB
SPC-1 Total System Price	\$1,924,748.73

In my opinion, these performance results were produced in compliance with the SPC requirements for the benchmark.

The testing was executed using the SPC-1 Toolkit Version 3.0 Build d34fb3c. The audit process was conducted in accordance with the SPC Policies and met the requirements for the benchmark.

A Letter of Good Faith was issued by the Test Sponsor, stating the accuracy and completeness of the documentation and testing data provided in support of the audit of this result.

A Full Disclosure Report for this result was prepared by InfoSizing, reviewed and approved by the Test Sponsor, and can be found at www.spcresults.org under the Submission Identifier **A31013**.

The independent audit process conducted by InfoSizing included the verifications of the following items:

20 REG LANE • MANITOU SPRINGS, CO 80829 • 719-473-7555 • [WWW.SIZING.COM](http://www.sizing.com)

A31013

HUAWEI OCEANSTOR 18500 V5

p.2

- The physical capacity of the data repository;
- The total capacity of the Application Storage Unit (ASU);
- The accuracy of the Benchmark Configuration diagram;
- The tuning parameters used to configure the Benchmark Configuration;
- The Workload Generator commands used to execute the testing;
- The validity and integrity of the test result files;
- The compliance of the results from each performance test;
- The compliance of the results from the persistence test;
- The compliance of the submitted pricing model; and
- The differences between the tested and the priced configuration, if any.

The Full Disclosure Report for this result was prepared in accordance with the disclosure requirements set forth in the specification for the benchmark.

The following benchmark requirements, if any, were waived according to the SPC Policies:

- None.

Respectfully Yours,

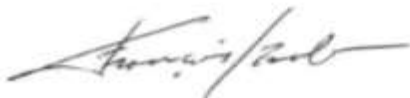

François Raab, Certified SPC Auditor

20 KEEC LANE • MANITOU SPRINGS, CO 80829 • 719-473-7555 • WWW.SIZING.COM

LETTER OF GOOD FAITH

HUAWEI

Huawei Technologies Co., Ltd.
Huawei Industrial Base, Bantian, Longgang
Shenzhen city
Guangdong province
China
Tel: 0086-755-28780808
<http://www.huawei.com/en/>

Date: May 25, 2018

From: Huawei Technologies Co., Ltd.

To: Mr. Francois Raab, Certified SPC Auditor
InfoSizing
20 Kreg Lane
Manitou Springs, CO 80829

Subject: SPC-1 Letter of Good Faith for the Huawei OceanStor 18500 V5

Huawei Technologies Co., Ltd. is the SPC-1 Test Sponsor for the above listed product. To the best of our knowledge and belief, the required SPC-1 benchmark results and materials we have submitted for that product are complete, accurate, and in full compliance with V3.6 of the SPC-1 benchmark specification.

In addition, we have reported any items in the Benchmark Configuration and execution of the benchmark that affected the reported results even if the items are not explicitly required to be disclosed by the SPC-1 benchmark specification.

Signed:  Date: 2018.05.25

Meng Guangbin
President of Storage Product Line



SPC BENCHMARK 1™

EXECUTIVE SUMMARY

HUAWEI TECHNOLOGIES CO., LTD HUAWEI OCEANSTOR 18500 V5

SPC-1 IOPS™	4,800,419
SPC-1 Price-Performance™	\$400.96/SPC-1 KIOPS™
SPC-1 IOPS™ Response Time	0.821 ms
SPC-1 Overall Response Time	0.513 ms
SPC-1 ASU Capacity	109,093 GB
SPC-1 ASU Price	\$17.65/GB
SPC-1 Total System Price	\$1,924,748.73
Data Protection Level	Protected 2 (RAID-10)
Physical Storage Capacity	343,680 GB
Pricing Currency / Target Country	U.S. Dollars / USA

SPC-1 V3.6

SUBMISSION IDENTIFIER: A31013

SUBMITTED FOR REVIEW: MAY 28, 2018

Benchmark Configuration Diagram

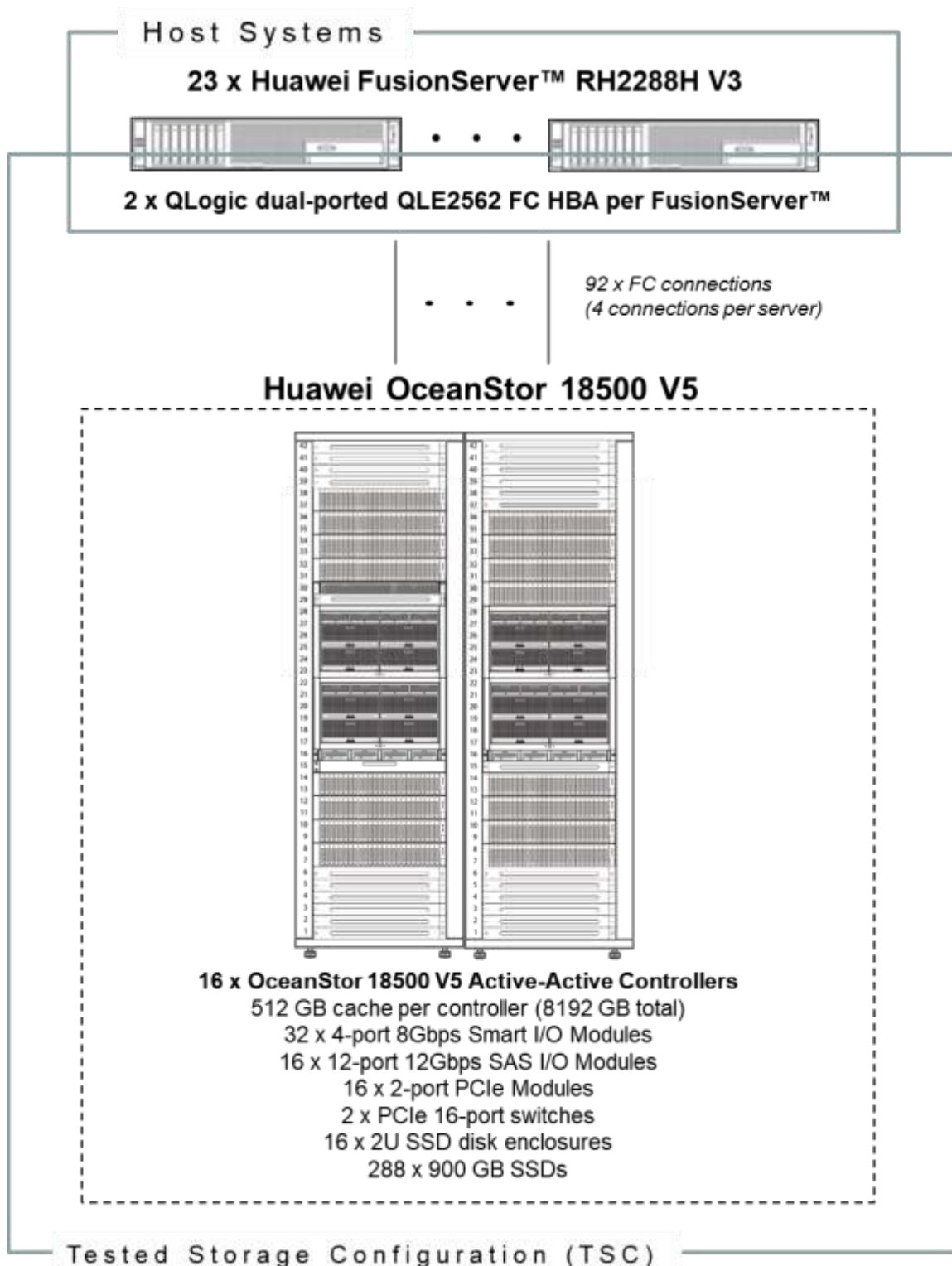

Tested Storage Product Description

Huawei's OceanStor 18500/18800 V5 mission-critical all-flash storage systems are dedicated to providing the highest level of data services for enterprises' mission-critical businesses.

Innovative SmartMatrix 2.0 architecture, industry-leading scalability, flash-enabled performance, and hybrid-cloud-ready solution provide the optimal data services for enterprises.

The OceanStor 18500/18800 V5 systems satisfy the storage requirements of large-database OLTP/OLAP and cloud computing, making it a perfect choice for the government, finance, telecommunications, and manufacturing sectors.

For more details, visit:

<http://e.huawei.com/en/products/cloud-computing-dc/storage/massive-storage/18500-18800-v5>

Priced Storage Configuration Components

46 x QLogic dual-ported QLE2562 FC HBA
16 x OceanStor 18500 V5 Active-Active Controllers, each with: 512 GB cache (8192 GB total) 2 x 4-port 8Gbps Smart I/O Modules
16 x 12-port 12Gbps SAS I/O Modules
16 x 2U disk enclosures, each with: 18 x 900 GB SSDs (288 total)
2 x PCIe 16-port switches
1 x Service Processor
1 x 8-port KVM

Storage Configuration Pricing

	Description	Qty	Unit Price	Ext. Price	Disc.	Disc. Price
Hardware & Software						
85V5-4C2048G-AC-HW	OceanStor 18500 V5 Engine (6U, Four Controller, AC240HVDC, 4*512GB Cache, 32*8Gb FC, 48*port 4*12Gb SAS,SPE73C0600)	4	501,015.00	2,004,060.00	72%	561,136.80
DV5-LPU5P2PCIE	2 port PCIe I/O module(w ith tw o NT Ports)	16	811.00	12,976.00	72%	3,633.28
HSSD-900G2S-A6	900GB SSD SAS Disk Unit(2.5")	288	10,624.00	3,059,712.00	75%	764,928.00
DAE52525U2-AC-A3	Disk Enclosure (2U,AC240HVDC, 2.5", Expanding Module, 25 Disk Slots, w ithout Disk Unit, DAE52525U2)	16	8,364.50	133,832.00	72%	37,472.96
PRACK-SYS-H-AC	OceanStor 18000 Series System Primary Cabinet (w ith Service Processor, KVM, External MiniSAS HD Cable, Pow er Cable)	1	54,609.00	54,609.00	0%	54,609.00
SRACK-SYS-H-AC	OceanStor 18000 Series System Second Cabinet (w ith External MiniSAS HD Cable, Pow er Cable)	1	34,021.00	34,021.00	0%	34,021.00
N8GHBA000	QLOGIC QLE2562 HBA Card, PCIe, 8Gbps DualPort , Fiber Channel Multimode LC Optic Interface, English Manual, No Drive CD	46	1,698.00	78,108.00	0%	78,108.00
SWITCH-V5H2	PCIe 3.0 Sw itch (AC240HVDC, 8GB Cache, 16 Port, w ith 16*Quadw ire 40 Gb/s Parallel AOC for PCIe 3.0, SWE1600P08)	2	11,472.00	22,944.00	0%	22,944.00
SN2F01FCPC	Patch Cord, DLC/PC, DLC/PC, Multi-mode, 3m, A1a.2, 2mm, 42mm DLC, OM3 bending insensitive	92	14.00	1,288.00	0%	1,288.00
85V5-LBASIC-N	License (Including OceanStor OS, Device Manager SmartThin, SmartMotion, SmartQoS, SmartPartition, SmartCache, SmartMigration, SmartErase, SmartMulti-tenant and SystemReporter, UltraPath)	1	149,505.00	149,505.00	72%	41,861.40
Hardware & Software Subtotal						1,600,002.44

Support & Maintenance						
02351QHB-88134ULF-36	OceanStor 18500 V5 Engine(6U, Four Controller, AC\240HVDC,4*512GB Cache, 32*8Gb FC, 48*port 4*12Gb SAS, SPE73C0600) Hi-Care Onsite Premier 24x7x4H Engineer Onsite Service-36Month(s)	4	12,855.60	51,422.40	0%	51,422.40
02351RYF-88134ULF-36	900GB SSD SAS Disk Unit(2.5")-Hi-Care Onsite Premier 24x7x4H Engineer Onsite Service-36Month(s)	288	244.80	70,502.40	0%	70,502.40
88034JGX-88134UHK-36	License (Including OceanStor OS, Device Manager, SmartThin, SmartMotion, SmartQoS, SmartPartition, SmartCache, SmartMigration, SmartErase, SmartMulti-tenant and SystemReporter, UltraPath) Hi-Care Application Software Upgrade Support Service-36Month(s)	1	59,626.80	59,626.80	0%	59,626.80
8812099165	OceanStor 18500 V5 Installation Service - Engineering	1	143,194.69	143,194.69	0%	143,194.69
Support & Maintenance Subtotal						324,746.29
SPC-1 Total System Price						1,924,748.73
SPC-1 IOPS™						4,800,419
SPC-1 Price-Performance™ (\$/SPC-1 KIOPS™)						400.96
SPC-1 ASU Capacity (GB)						109,093
SPC-1 ASU Price (\$/GB)						17.65

Third-Party Reseller: Huawei Technologies Co., Ltd. only sells its products to third-party resellers who, in turn, sell those products to U.S. customers. The above reflects the pricing quoted by one of those third-party resellers. See Appendix B of the Full Disclosure Report for a copy of the third-party reseller's quotation.

Discount Details: The discounts shown are based on the storage capacity purchased and are generally available.

Warranty: Hi-Care Premier On-Site Service include: 7x24 Technical Assistance Center Access. Access to all new software updates and Online Support. 24x7 with 4-hour On-site Hardware Replacement.

Availability Date: Currently available.

Response Time and Throughput Graph

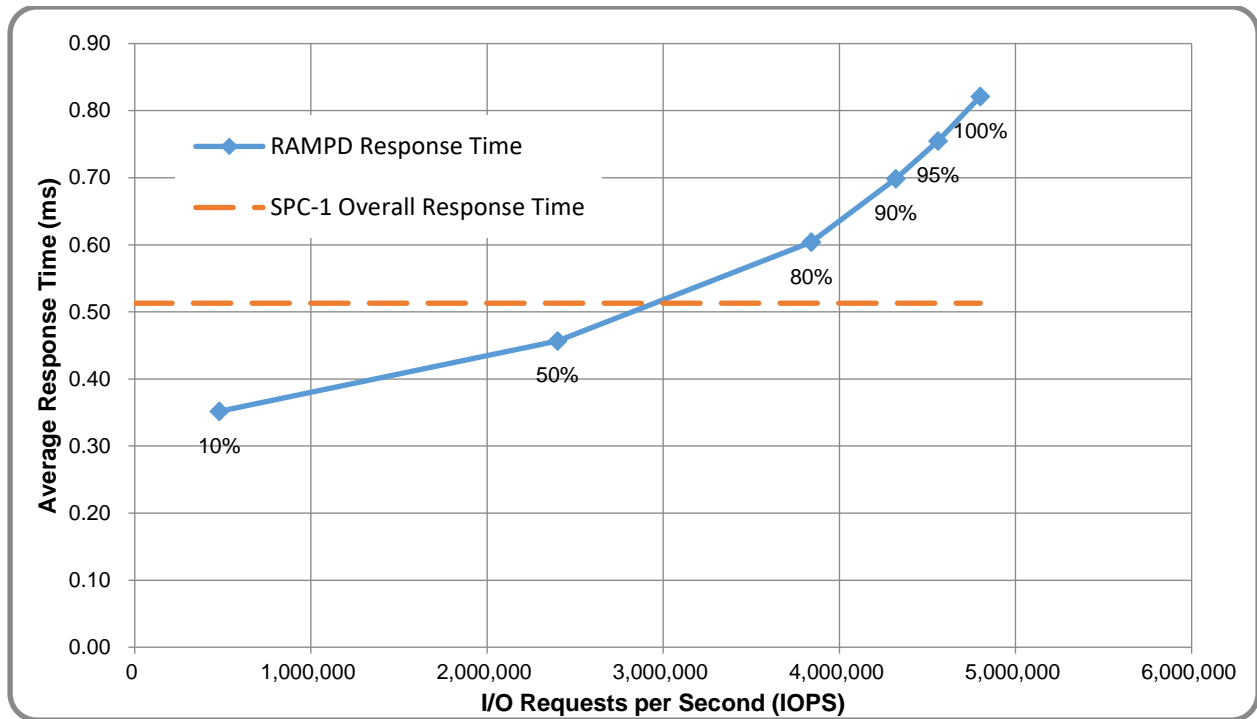

Contact Information	
Test Sponsor Primary Contact	Huawei Technologies Co., Ltd. – www.huawei.com Zhong Xu – xuzhong@huawei.com
SPC Auditor	InfoSizing – www.sizing.com Francois Raab – francois@sizing.com

Revision Information	
SPC Benchmark 1™ Revision	V3.6.0
SPC-1 Workload Generator Revision	V3.0 build d34fb3c
Publication Revision History	First Edition

CONFIGURATION INFORMATION

Benchmark Configuration and Tested Storage Configuration

The following diagram illustrates the Benchmark Configuration (BC), including the Tested Storage Configuration (TSC) and the Host System(s).

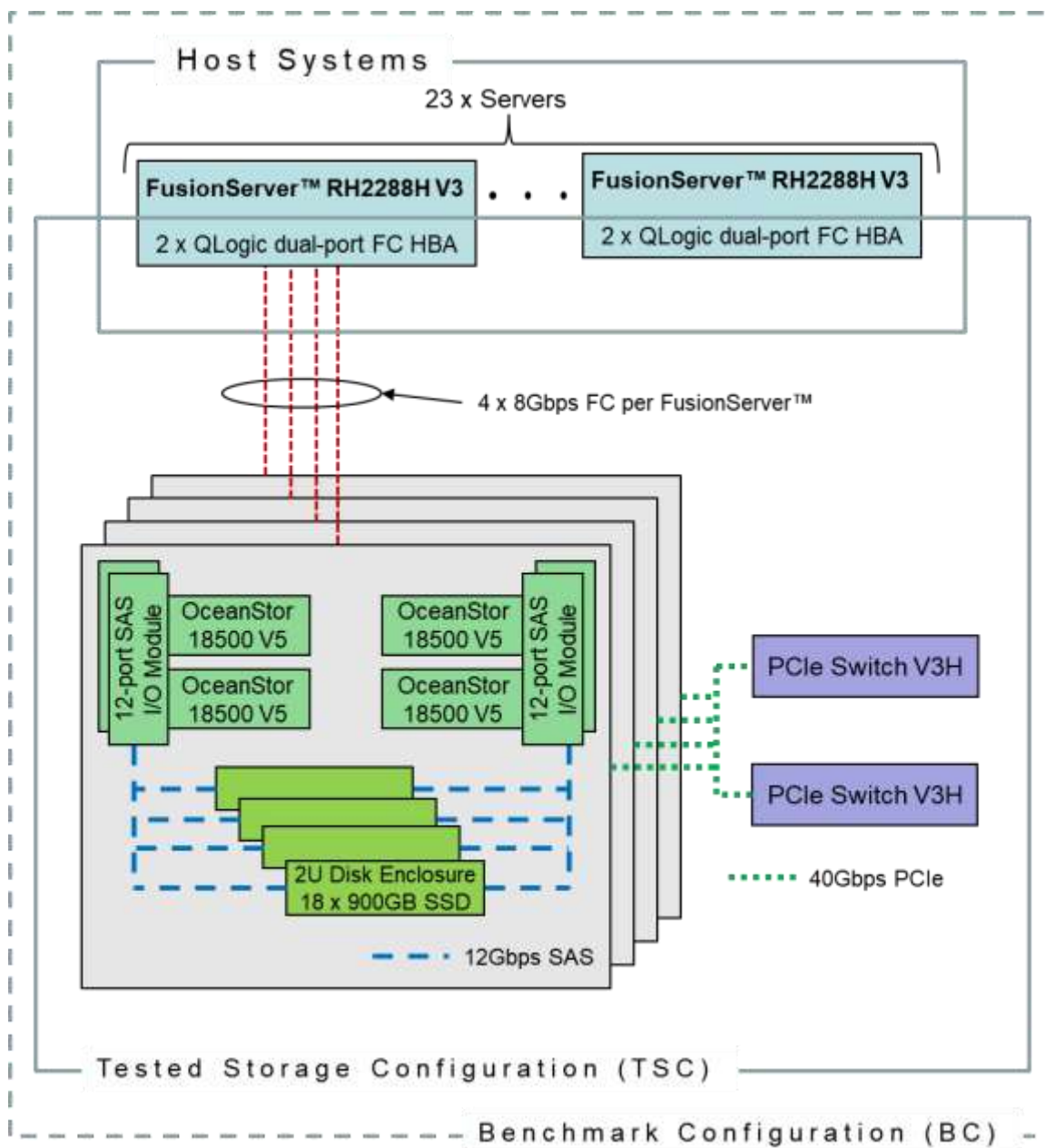

Storage Network Configuration

The Tested Storage Configuration (TSC) involved an external storage subsystem made of 16 Huawei OceanStor 18500 V5, driven by 23 host systems (Huawei FusionServer RH2288H V3). The OceanStor controllers were grouped in sets of four, forming four OceanStor Engines. Each FusionServer host system connected one-to-one to each OceanStor Engine. That connection was established via a port from one of the two dual-port Fibre Chanel HBAs on the FusionServer; and a port from one of the eight 4-port Smart I/O Modules on the OceanStor Engine, leaving nine of these ports inactive in each Engine. These Fibre Chanel paths operated at 8Gbps.

Host System and Tested Storage Configuration Components

The following table lists the components of the Host System(s) and the Tested Storage Configuration (TSC).

Host Systems
23 x Huawei FusionServer™ RH2288H V3 2 x Intel® Xeon® E5-2667 v4 (3.2 GHz, 8 Cores, 25 MB L3) 128 GB Main Memory Red Hat Enterprise Linux 7.1
Priced Storage Configuration
46 x QLogic dual-ported QLE2562 FC HBA 16 x OceanStor 18500 V5 Active-Active Controllers, each with: 512 GB cache (8192 GB total) 2 x 4-port 8Gbps Smart I/O Modules 16 x 12-port 12Gbps SAS I/O Modules 16 x 2U disk enclosures, each with: 18 x 900 GB SSDs (288 total) 2 x PCIe 16-port switches 1 x Service Processor 1 x 8-port KVM

Differences Between Tested and Priced Storage Configurations

There were no differences between the Tested Storage Configuration and the Priced Storage Configuration.

Component Changes in Revised Full Disclosure Report

The following table outlines component changes that were made in revisions to this Full Disclosure Report.

Original Component	Revised Component	Description of Change
n/a	n/a	Initial submission

Benchmark Configuration Creation Process

Customer Tuning Parameters and Options

All the customer tuning parameters and options that have been altered from their default values for this benchmark are included in Appendix C and in the Supporting Files (see Appendix A).

Tested Storage Configuration Creation

A detailed description of how the logical representation of the TSC was created is included in Appendix D and in the Supporting Files (see Appendix A).

Tested Storage Configuration Inventory

An inventory of the components in the TSC, as seen by the Benchmark Configuration, is included in Appendix E and in the Supporting Files (see Appendix A).

Workload Generator Storage Configuration

The SPC-1 Workload Generator storage configuration commands and parameters used to invoke the execution of the tests are included in Appendix F and in the Supporting Files (see Appendix A).

Logical Volume Capacity and ASU Mapping

The following table details the capacity of each ASU and how they are mapped to logical volumes (LV).

	LV per ASU	LV Capacity	Used per LV	Total per ASU	% ASU Capacity
ASU-1	18	2,727.4	2,727.3	49,091.5	45.00%
ASU-2	18	2,727.4	2,727.3	49,091.5	45.00%
ASU-3	2	5,454.7	5,454.6	10,909.2	10.00%
SPC-1 ASU Capacity				109,092.2	

Physical Storage Capacity and Utilization

The following table details the Physical Capacity of the storage devices and the Physical Capacity Utilization (percentage of Total Physical Capacity used) in support of hosting the ASUs.

Devices	Count	Physical Capacity	Total Capacity
900GB SSD	288	895.0	257,760.0
Total Physical Capacity			257,760.0
Physical Capacity Utilization			42.32%

Data Protection

The data protection level used for all logical volumes was **Protected 2**, which was accomplished by configuring 16 pools of 18 drives into 16 RAID-10 arrays.

BENCHMARK EXECUTION RESULTS

This portion of the Full Disclosure Report documents the results of the various SPC-1 Tests, Test Phases, and Test Runs.

Benchmark Execution Overview

Workload Generator Input Parameters

The SPC-1 Workload Generator commands and input parameters for the Test Phases are presented in the Supporting Files (see Appendix A).

Primary Metrics Test Phases

The benchmark execution consists of the Primary Metrics Test Phases, including the Test Phases SUSTAIN, RAMPD_100 to RAMPD_10, RAMPU_50 to RAMPU_100, RAMP_0, REPEAT_1 and REPEAT_2.

Each Test Phase starts with a transition period followed by a Measurement Interval.

Measurement Intervals by Test Phase Graph

The following graph presents the average IOPS and the average Response Times measured over the Measurement Interval (MI) of each Test Phase.

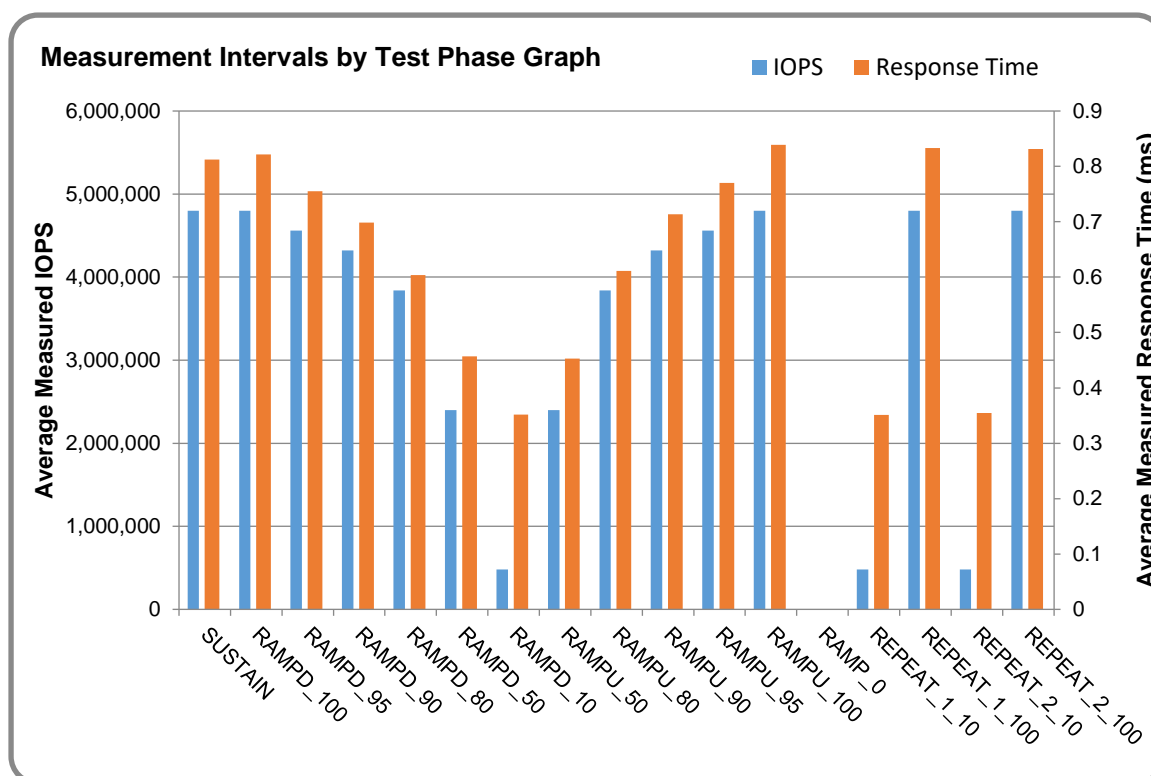

Exception and Waiver

None.

SUSTAIN Test Phase

SUSTAIN – Results File

The results file generated during the execution of the SUSTAIN Test Phase is included in the Supporting Files (see Appendix A) as follows:

- SPC1_METRICS_0_Raw_Results.xlsx

SUSTAIN – Execution Times

Interval	Start Time	End Time	Duration
Transition Period	9-May-18 12:30:16	9-May-18 18:30:16	6:00:00
Measurement Interval	9-May-18 18:30:16	10-May-18 02:30:17	8:00:01

SUSTAIN – Throughput Graph

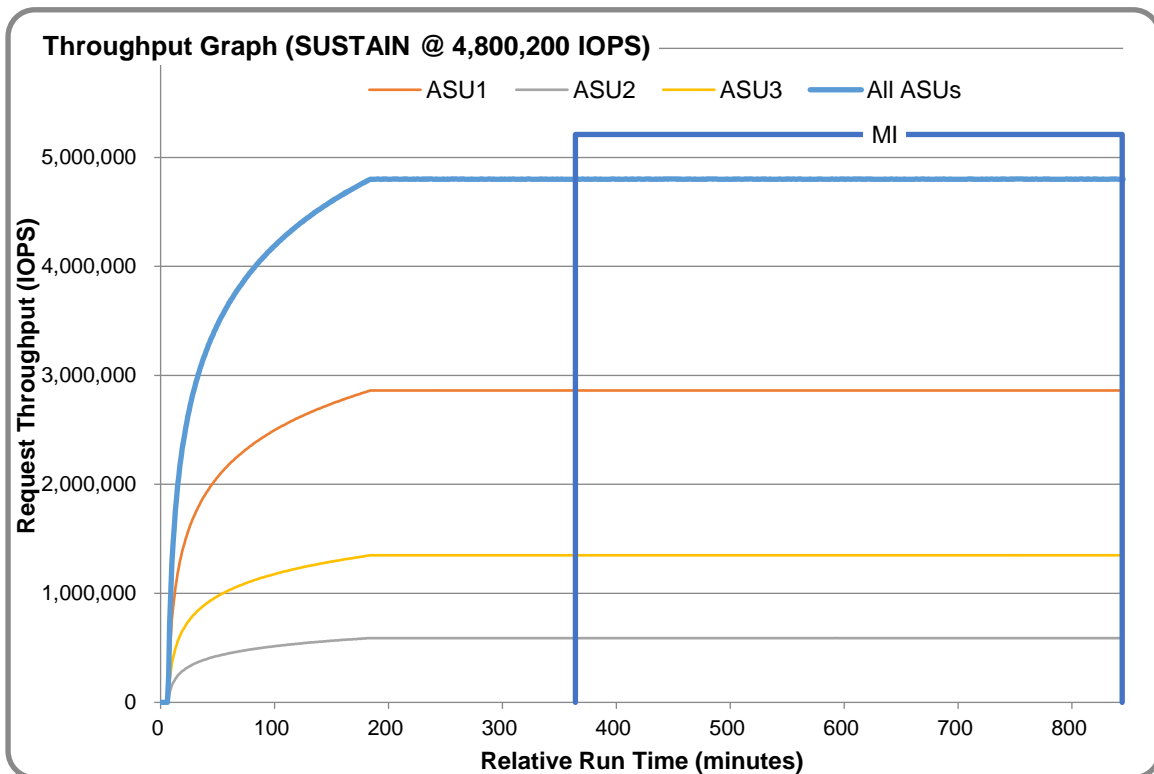

SUSTAIN – Response Time Graph

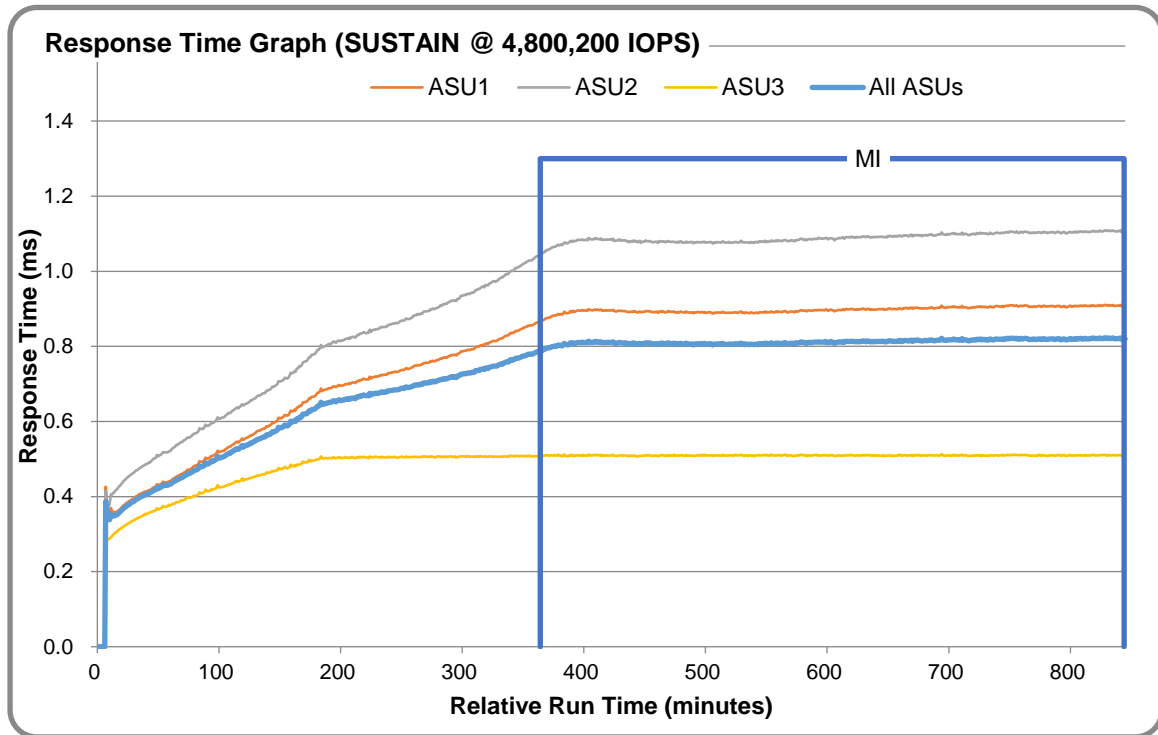

SUSTAIN – Data Rate Graph

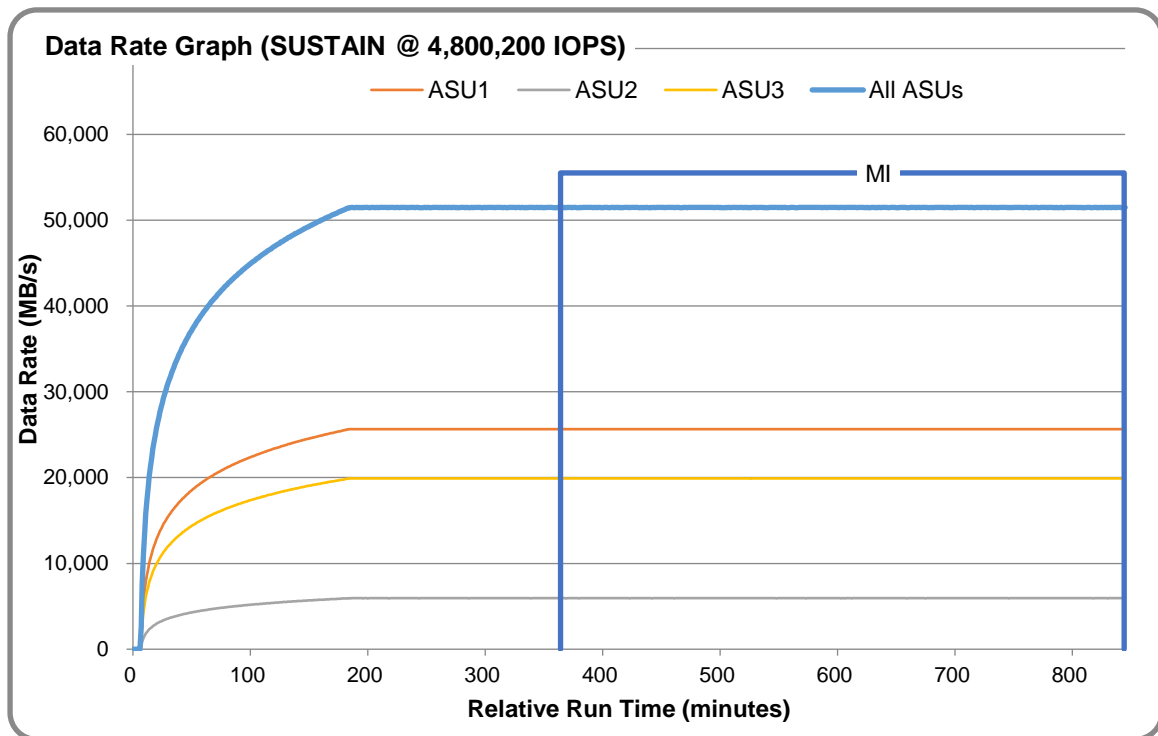

SUSTAIN – Response Time Frequency Graph

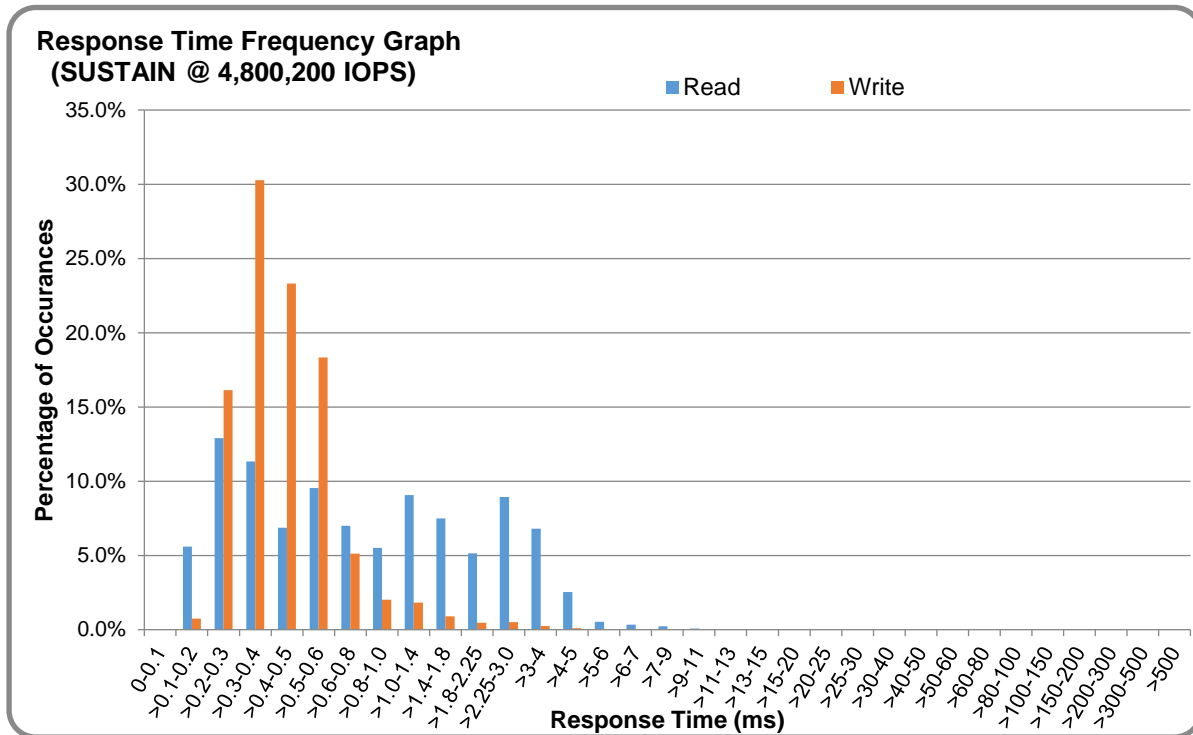

SUSTAIN – Intensity Multiplier

The following table lists the targeted intensity multiplier (Defined), the measured intensity multiplier (Measured) for each I/O STREAM, its coefficient of variation (Variation) and the percentage of difference (Difference) between Target and Measured.

	ASU1-1	ASU1-2	ASU1-3	ASU1-4	ASU2-1	ASU2-2	ASU2-3	ASU3-1
Defined	0.0350	0.2810	0.0700	0.2100	0.0180	0.0700	0.0350	0.2810
Measured	0.0350	0.2810	0.0700	0.2100	0.0180	0.0700	0.0350	0.2810
Variation	0.0003	0.0001	0.0002	0.0001	0.0004	0.0002	0.0003	0.0001
Difference	0.006%	0.001%	0.004%	0.000%	0.005%	0.004%	0.006%	0.002%

RAMPD_100 Test Phase

RAMPD 100 – Results File

The results file generated during the execution of the RAMPD_100 Test Phase is included in the Supporting Files (see Appendix A) as follows:

- SPC1_METRICS_0_Raw_Results.xlsx

RAMPD 100 – Execution Times

Interval	Start Time	End Time	Duration
Transition Period	10-May-18 02:31:16	10-May-18 02:36:16	0:05:00
Measurement Interval	10-May-18 02:36:16	10-May-18 02:46:17	0:10:01

RAMPD 100 – Throughput Graph

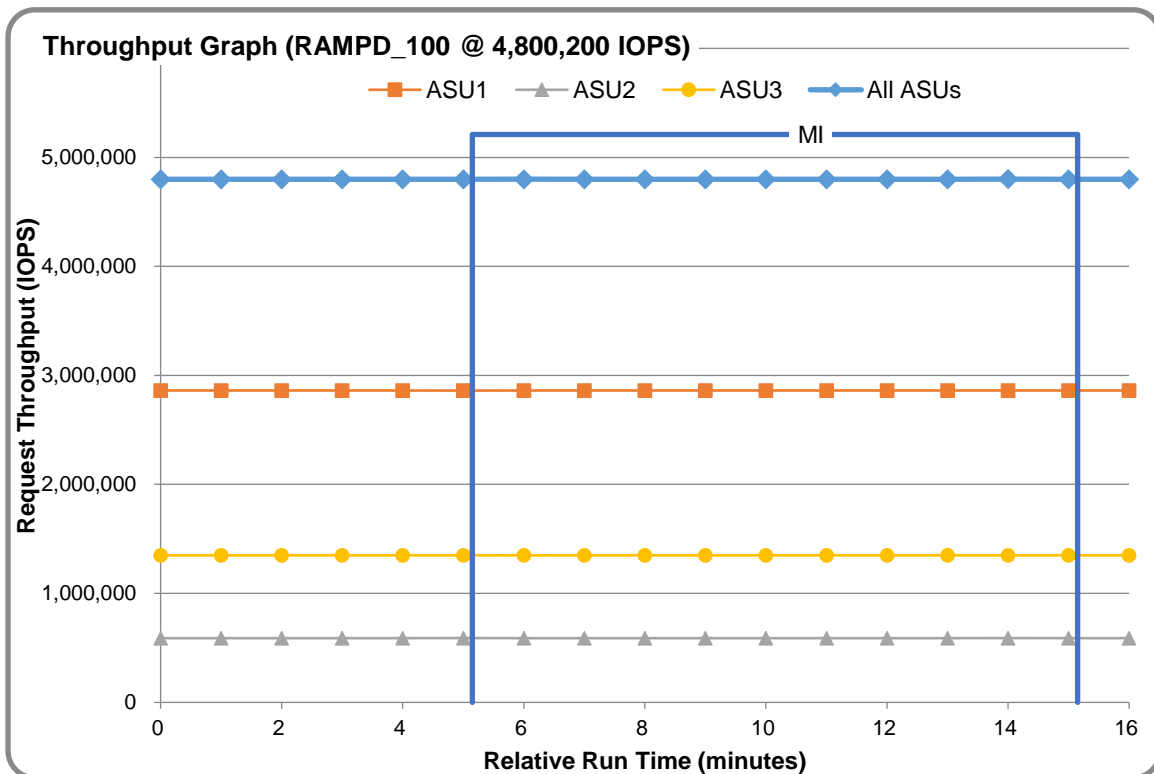

RAMPD 100 – Response Time Graph

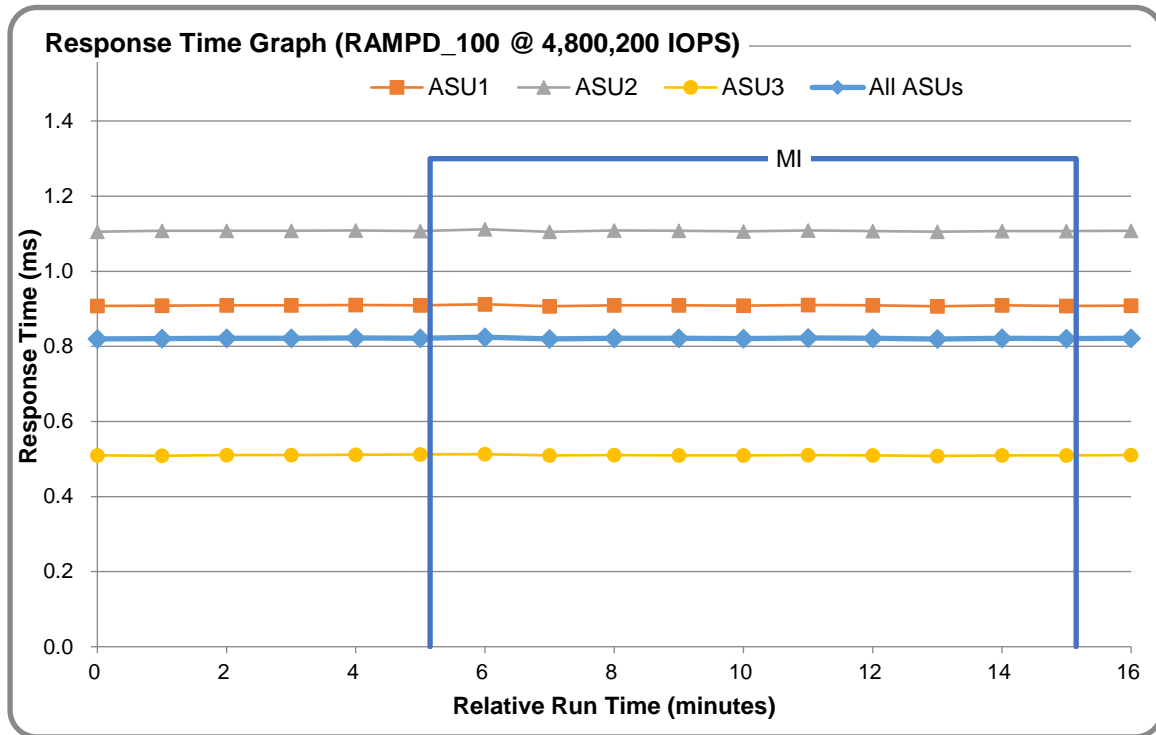

RAMPD 100 – Data Rate Graph

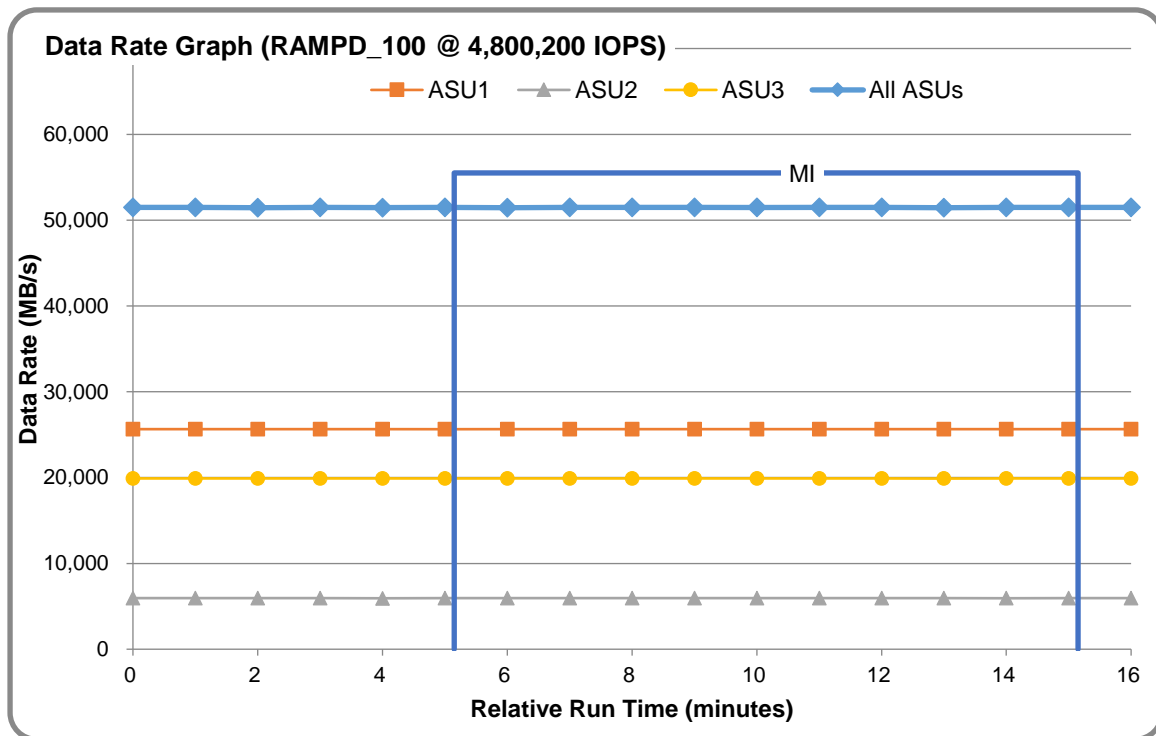

RAMPD 100 – Response Time Frequency Graph

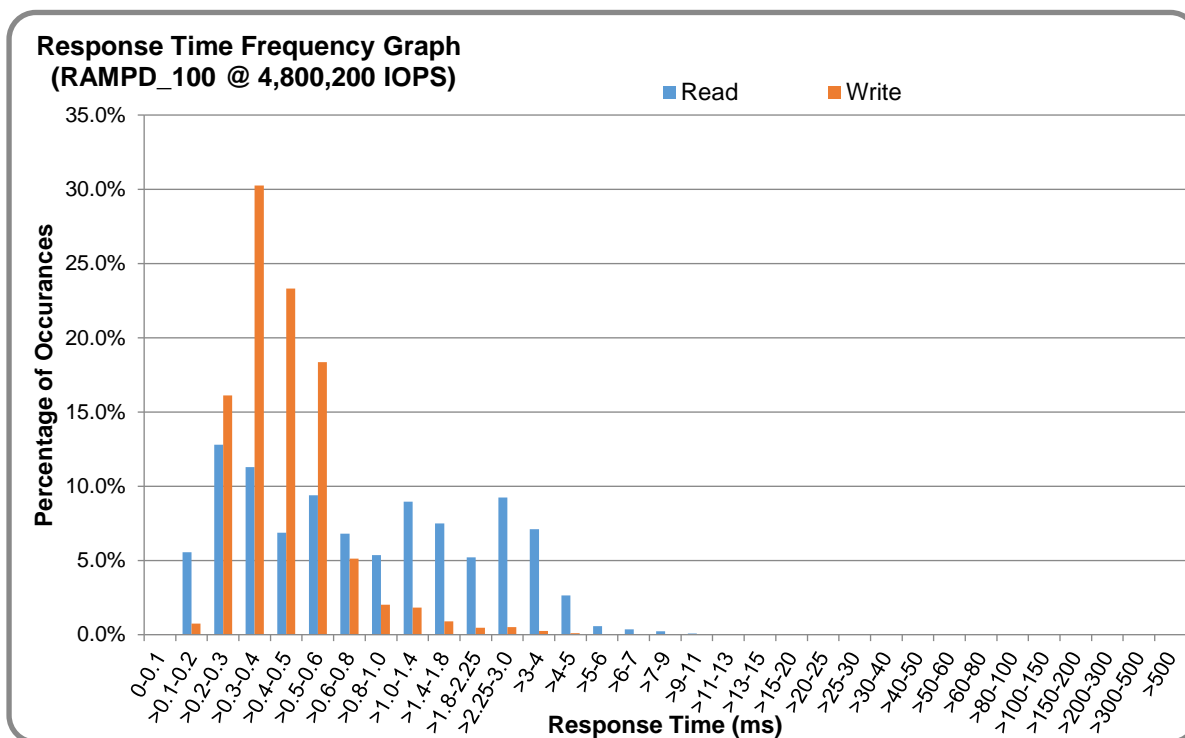

RAMPD 100 – Intensity Multiplier

The following table lists the targeted intensity multiplier (Defined), the measured intensity multiplier (Measured) for each I/O STREAM, its coefficient of variation (Variation) and the percentage of difference (Difference) between Target and Measured.

	ASU1-1	ASU1-2	ASU1-3	ASU1-4	ASU2-1	ASU2-2	ASU2-3	ASU3-1
Defined	0.0350	0.2810	0.0700	0.2100	0.0180	0.0700	0.0350	0.2810
Measured	0.0350	0.2810	0.0700	0.2100	0.0180	0.0700	0.0350	0.2810
Variation	0.0003	0.0001	0.0002	0.0001	0.0006	0.0002	0.0002	0.0001
Difference	0.001%	0.003%	0.000%	0.002%	0.024%	0.004%	0.007%	0.002%

RAMPD 100 – I/O Request Summary

I/O Requests Completed in the Measurement Interval	2,880,276,193
I/O Requests Completed with Response Time <= 30 ms	2,880,265,339
I/O Requests Completed with Response Time > 30 ms	10,854

Response Time Ramp Test

Response Time Ramp Test – Results File

The results file generated during the execution of the Response Time Ramp Test is included in the Supporting Files (see Appendix A) as follows:

- **SPC1_METRICS_0_Raw_Results.xlsx**

Response Time Ramp Test – Phases

The Response Time Ramp Test is comprised of 11 Test Phases, including six Ramp-Down Phases (executed at 100%, 95%, 90%, 80%, 50%, and 10% of the Business Scaling Unit) and five Ramp-Up Phases (executed at 50%, 80%, 90%, 95%, and 100% of the Business Scaling Unit).

Response Time Ramp Test – Average Throughput Graph

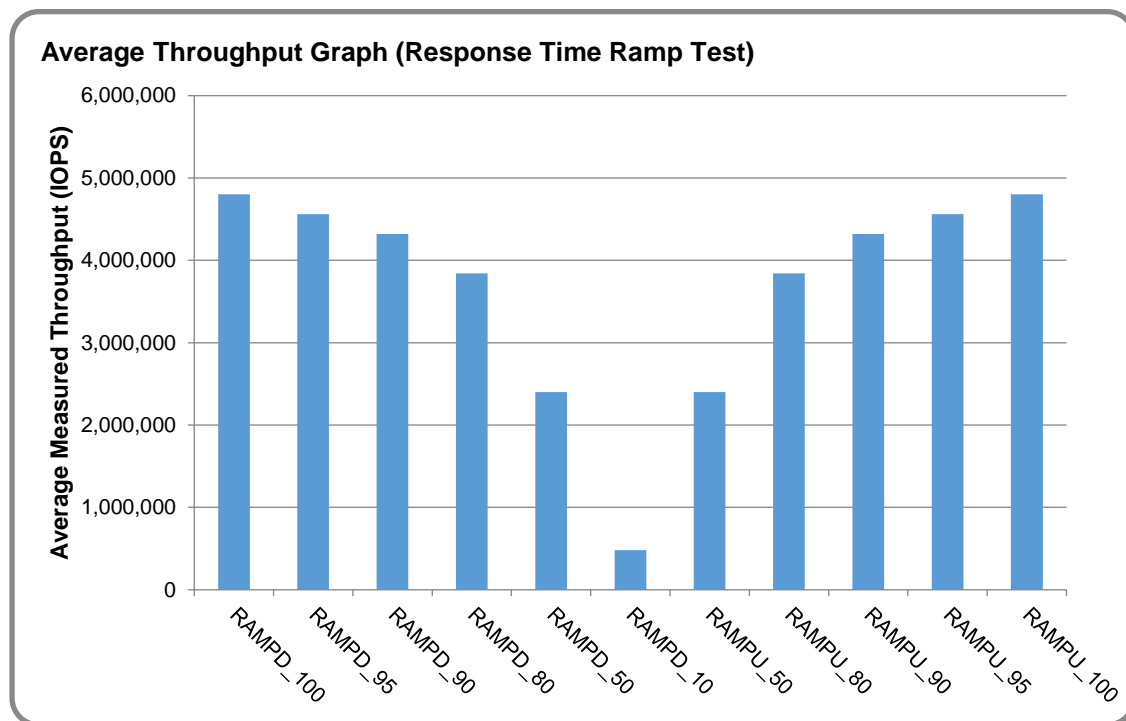

Response Time Ramp Test – Average Response Time Graph

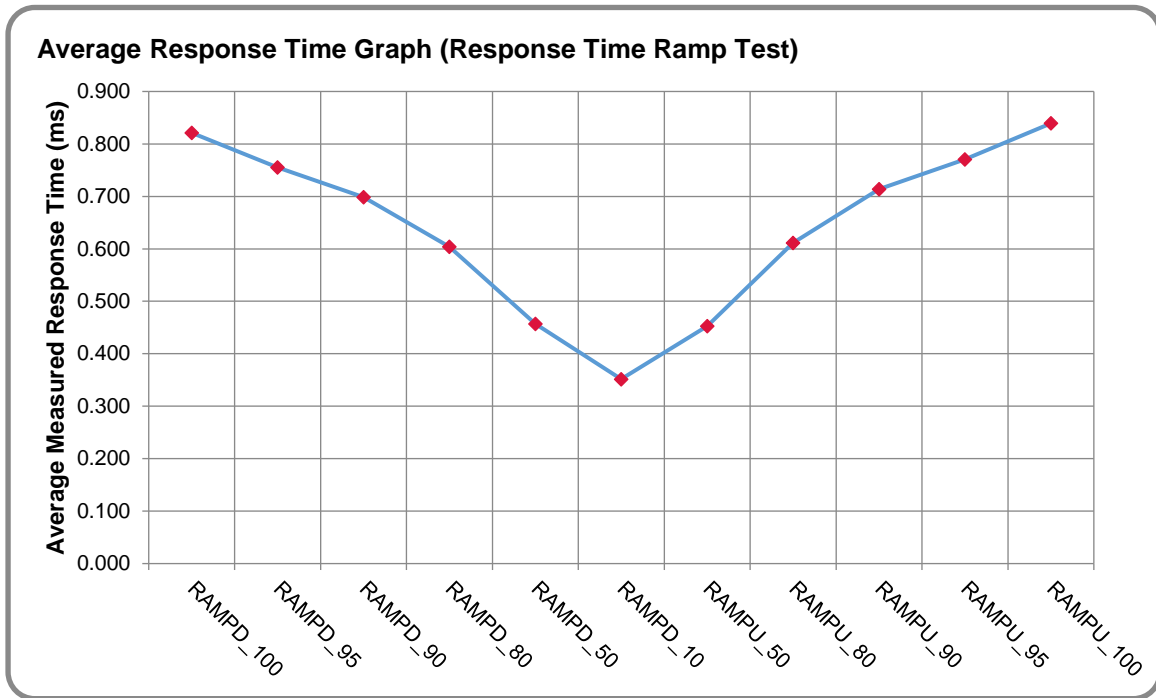

Response Time Ramp Test – RAMPD 10 Response Time Graph

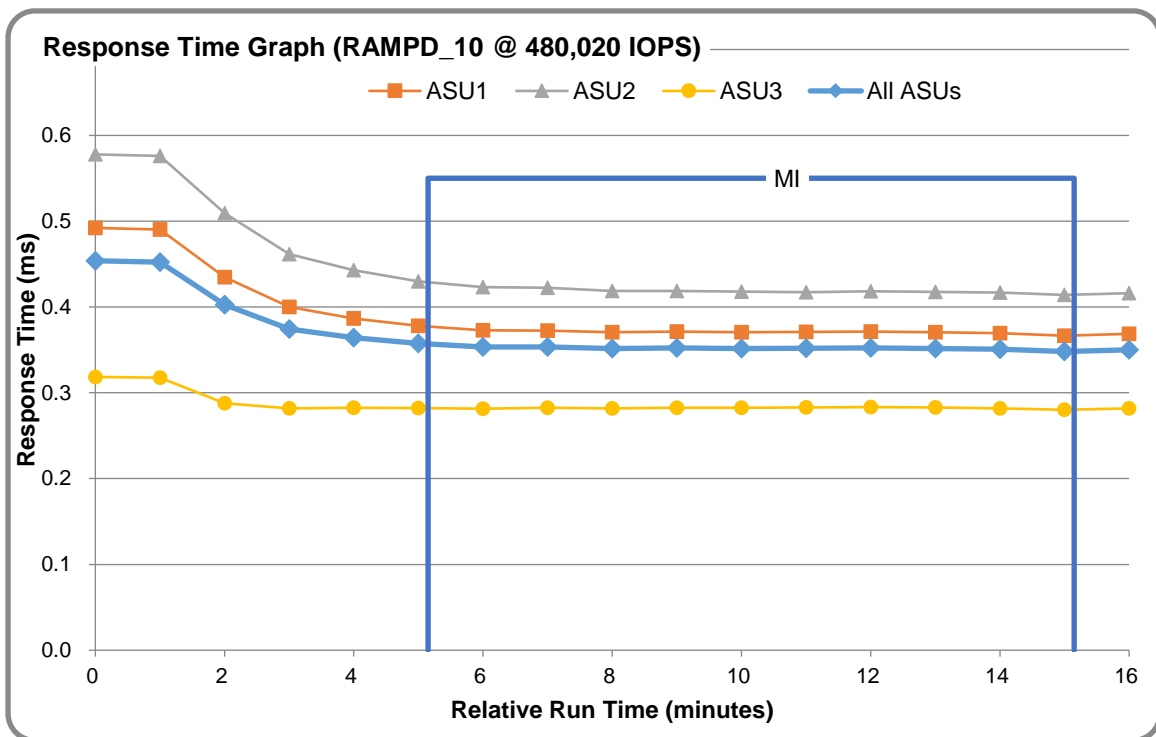

Repeatability Test

Repeatability Test Results File

The results file generated during the execution of the Repeatability Test is included in the Supporting Files (see Appendix A) as follows:

- SPC1_METRICS_0_Raw_Results.xlsx

Repeatability Test Results

The throughput measurements for the Response Time Ramp Test (RAMPD) and the Repeatability Test Phases (REPEAT_1 and REPEAT_2) are listed in the tables below.

Test Phase	100% IOPS	10% IOPS
RAMPD	4,800,419.6	480,010.6
REPEAT_1	4,800,504.7	480,019.5
REPEAT_2	4,800,418.2	480,019.9

REPEAT 1 100 – Throughput Graph

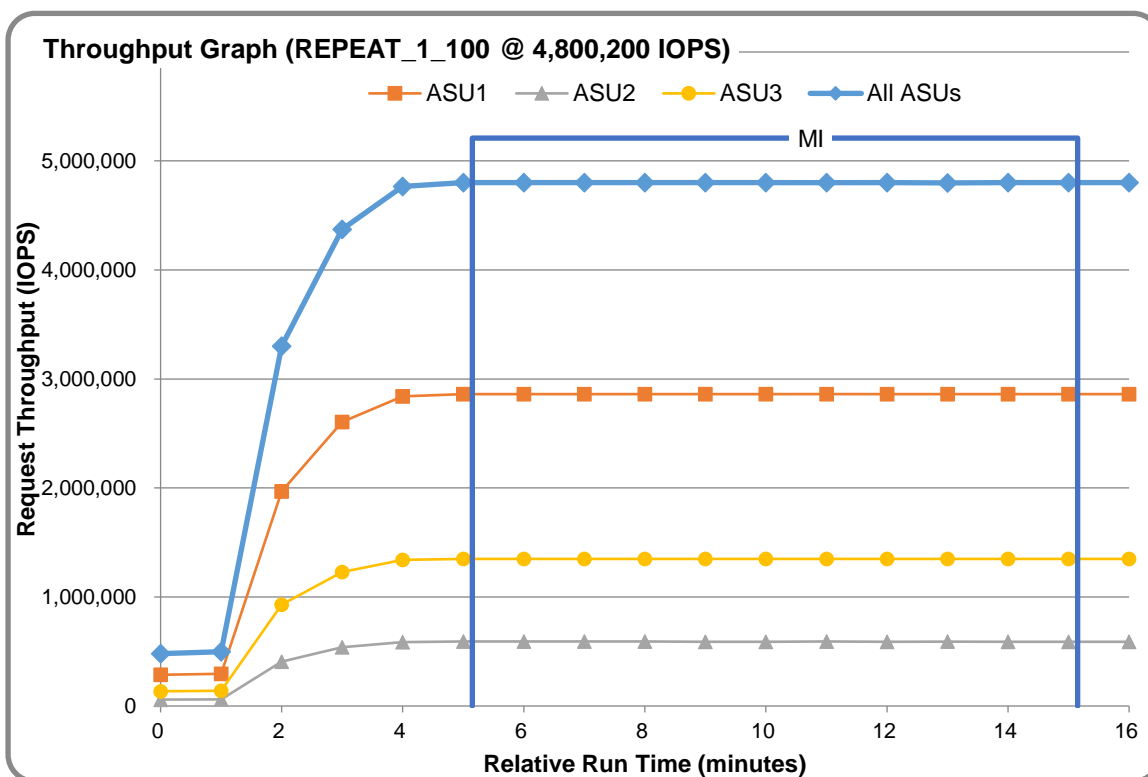

REPEAT 1 100 – Response Time Graph

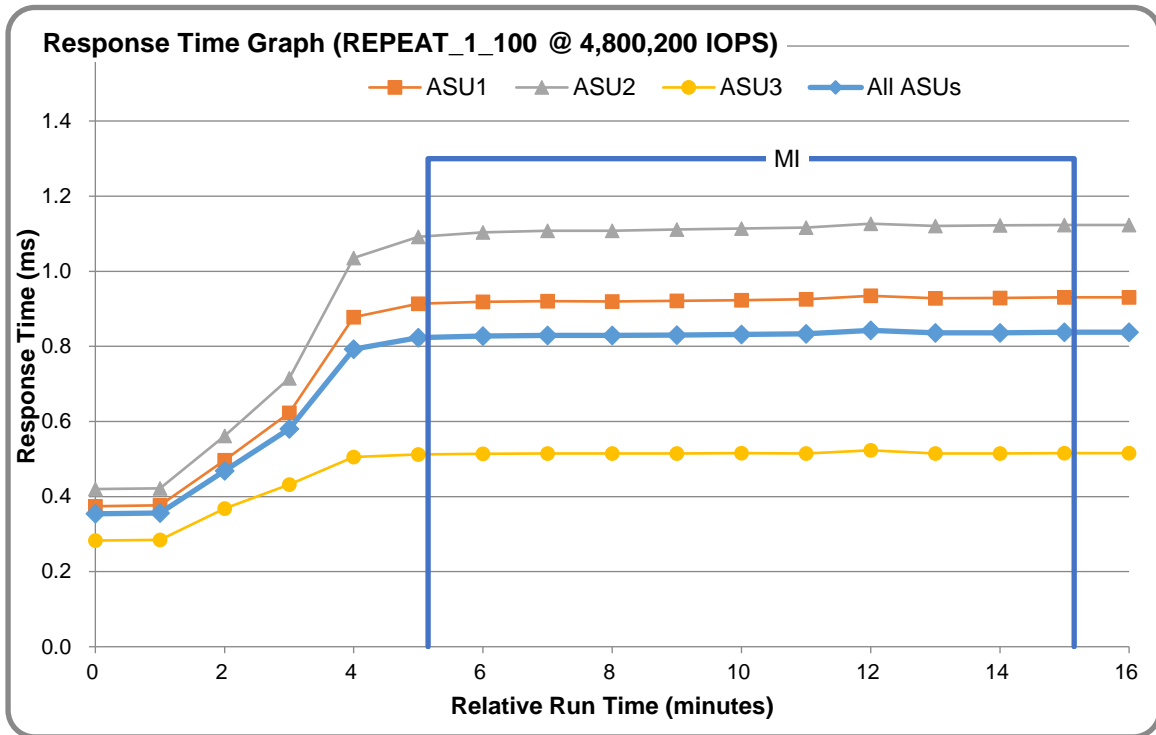

REPEAT 2 100 – Throughput Graph

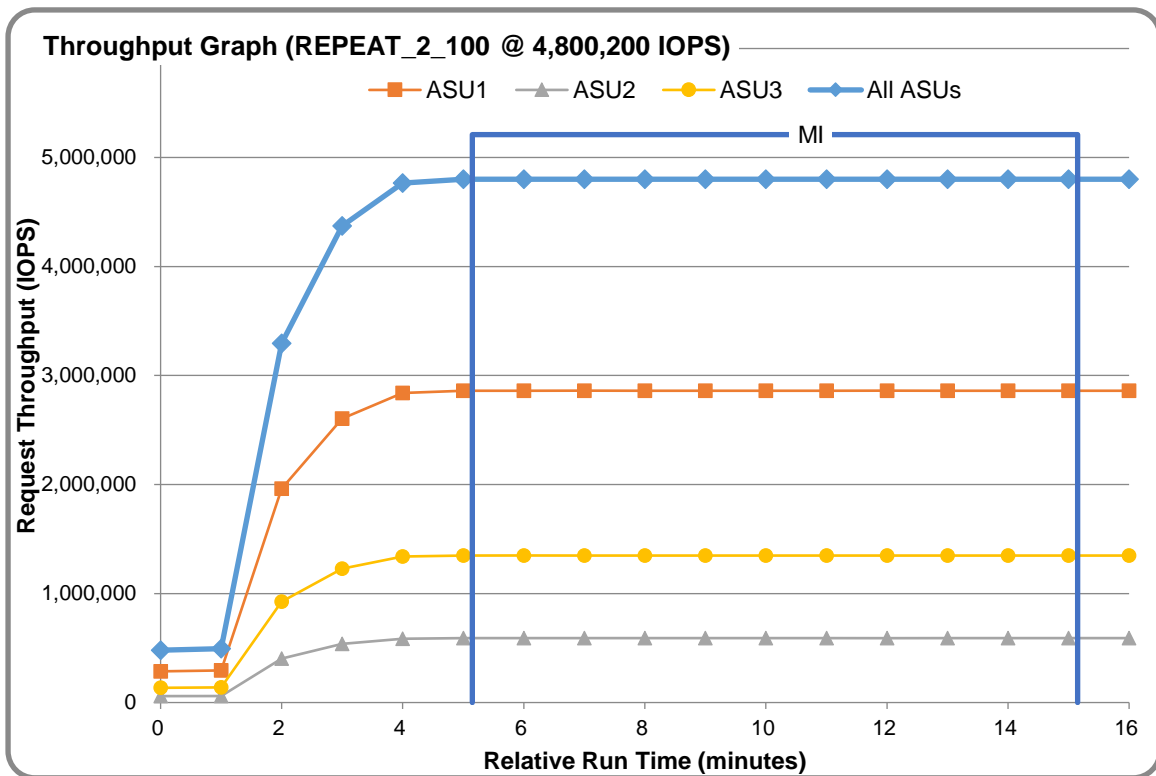

REPEAT 2 100 – Response Time Graph

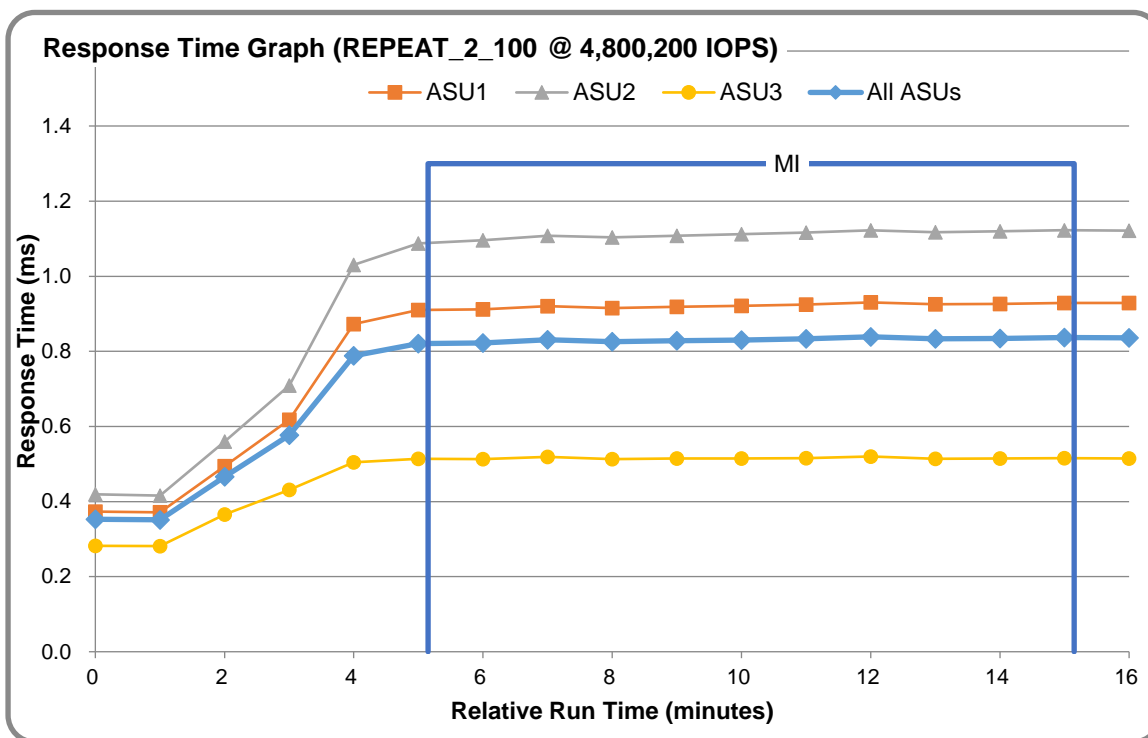

Repeatability Test – Intensity Multiplier

The following tables lists the targeted intensity multiplier (Defined), the measured intensity multiplier (Measured) for each I/O STREAM, its coefficient of variation (Variation) and the percent of difference (Difference) between Target and Measured.

REPEAT_1_100 Test Phase

	ASU1-1	ASU1-2	ASU1-3	ASU1-4	ASU2-1	ASU2-2	ASU2-3	ASU3-1
Defined	0.0350	0.2810	0.0700	0.2100	0.0180	0.0700	0.0350	0.2810
Measured	0.0350	0.2810	0.0700	0.2100	0.0180	0.0700	0.0350	0.2810
Variation	0.0003	0.0001	0.0002	0.0001	0.0004	0.0003	0.0003	0.0001
Difference	0.009%	0.004%	0.012%	0.003%	0.007%	0.013%	0.003%	0.006%

REPEAT_2_100 Test Phase

	ASU1-1	ASU1-2	ASU1-3	ASU1-4	ASU2-1	ASU2-2	ASU2-3	ASU3-1
Defined	0.0350	0.2810	0.0700	0.2100	0.0180	0.0700	0.0350	0.2810
Measured	0.0350	0.2810	0.0700	0.2100	0.0180	0.0700	0.0350	0.2810
Variation	0.0004	0.0001	0.0002	0.0001	0.0005	0.0003	0.0003	0.0001
Difference	0.007%	0.001%	0.011%	0.001%	0.003%	0.003%	0.007%	0.002%

Data Persistence Test

Data Persistence Test Results file

The results files generated during the execution of the Data Persistence Test is included in the Supporting Files (see Appendix A) as follows:

- **SPC1_PERSIST_1_0_Raw_Results.xlsx**
- **SPC1_PERSIST_2_0_Raw_Results.xlsx**

Data Persistence Test Execution

The Data Persistence Test was executed using the following sequence of steps:

- The PERSIST_1_0 Test Phase was executed to completion.
- The Benchmark Configuration was taken through an orderly shutdown process and powered off.
- The Benchmark Configuration was powered on and taken through an orderly startup process.
- The PERSIST_2_0 Test Phase was executed to completion.

Data Persistence Test Results

Data Persistence Test Phase: Persist1	
Total Number of Logical Blocks Written	296,864,268
Total Number of Logical Blocks Verified	149,656,998
Total Number of Logical Blocks that Failed Verification	147,207,270
Time Duration for Writing Test Logical Blocks (sec.)	0
Size in bytes of each Logical Block	300
Number of Failed I/O Requests in the process of the Test	8,192

Committed Data Persistence Implementation

The persistency of committed data is implemented at two levels. At the disk level, data loss is prevented through the use of RAID 10 arrays. At the controller level, all caches are mirrored across controllers, where write requests are only completed once the local cache has been successfully mirrored in another controller's cache. In addition, cache content is protected from a loss of power by flushing the cache content to permanent flash memory, as soon as a power loss is detected. The flushing action is powered by a battery backup located in each controller.

APPENDIX A: SUPPORTING FILES

The following table details the content of the Supporting Files provided as part of this Full Disclosure Report.

File Name	Description	Location
/SPC1_RESULTS	Data reduction worksheets	root
SPC1_INIT_0_Raw_Results.xlsx	Raw results for INIT Test Phase	/SPC1_RESULTS
SPC1_METRICS_0_Quick_Look.xlsx	Quick Look Test Run Overview	/SPC1_RESULTS
SPC1_METRICS_0_Raw_Results.xlsx	Raw results for Primary Metrics Test	/SPC1_RESULTS
SPC1_METRICS_0_Summary_Results.xlsx	Primary Metrics Summary	/SPC1_RESULTS
SPC1_PERSIST_1_0_Raw_Results.xlsx	Raw results for PERSIST1 Test Phase	/SPC1_RESULTS
SPC1_PERSIST_2_0_Raw_Results.xlsx	Raw results for PERSIST2 Test Phase	/SPC1_RESULTS
SPC1_Run_Set_Overview.xlsx	Run Set Overview Worksheet	/SPC1_RESULTS
SPC1_VERIFY_0_Raw_Results.xlsx	Raw results for first VERIFY Test Phase	/SPC1_RESULTS
SPC1_VERIFY_1_Raw_Results.xlsx	Raw results for second VERIFY Test Phase	/SPC1_RESULTS
/C_Tuning	Tuning parameters and options	root
aio-max-nr.sh	Set maximum asynchronous I/O	/C_Tuning
nr_requests.sh	Increase disk queue depth	/C_Tuning
scheduler.sh	Change the I/O scheduler	/C_Tuning
/D_Creation	Storage configuration creation	root
mklun.txt	Create the storage environment	/D_Creation
mkvolume.sh	Create the Logical Volumes	/D_Creation
/E_Inventory	Configuration inventory	root
shstorage.tcl	Captures profile of storage environment	/E_Inventory
profile1_volume.log	List of logical volumes before INIT	/E_Inventory
profile1_storage.log	List of storage devices before INIT	/E_Inventory
profile2_volume.log	List of logical volumes after restart	/E_Inventory
profile2_storage.log	List of storage devices after restart	/E_Inventory
/F_Generator	Workload generator	root
slave_asu.asu	Defining LUNs hosting the ASUs	/F_generator
23host.HST	Host configuration file	/F_generator
full_run.sh	Executing all test phases	/F_generator

APPENDIX B: THIRD PARTY QUOTATION



Address: 32 Broadway, Suite 401
New York, NY 10004
Tel: 212-809-6625
Email: sales@noviant.com

05/23/2018, Quote Valid 90 Days

No.	Model	Description	Qty.	Unit Price (USD)	Ext.Price (USD)	Disc. (off)	Total Disc. Price
1	Phase						
1.1	Location						
1.1.1	OceanStor 18500 V5 Main Equipment						
1.1.1.1	Controller Enclosure						
	85V5-4C2048G-AC-HW	OceanStor 18500 V5 Engine(5U,Four Controller,AC/240V/DC,4*512GB Cache,32*8Gb FC,48*port 4*12Gb SAS,SPE730600)	4	501,015.00	2,004,060.00	72.00%	561,136.80
1.1.1.2	Expanding Interface Module						
	DV5-LPUSP2PCIE	2 port PCIe I/O module(with two NT Ports)	16	811.00	12,976.00	72.00%	3,533.28
1.1.1.3	Disk Components						
	HSSD-900G2S-A6	900GB SSD SAS Disk Unit(2.5")	288	10,524.00	3,059,712.00	75.00%	764,928.00
1.1.1.4	Disk Enclosure						
	DAE52525U2-AC-A3	Disk Enclosure(2U,AC/240V/DC,2.5"Expanding Module,25-Disk Slots,without Disk)	16	8,364.50	133,832.00	72.00%	37,472.96
1.1.4	Cabinet						
	PRACK-SYS-H-AC	OceanStor 18000 Series System Primary Cabinet(with Service Processor,KVM,External MiniSAS HD Cable,Power Cable)	1	54,609.00	54,609.00	0.00%	54,609.00
	SRACK-SYS-H-AC	OceanStor 18000 Series System Second Cabinet(with External MiniSAS HD Cable,Power Cable)	1	34,021.00	34,021.00	0.00%	34,021.00
1.1.5	HBA						
	NI8HBA000	QLOGIC QLE2562 HBA Card,PCIe,8Gbps DualPort ,Fiber Channel Multimode LC Optic Interface,English Manual, No Drive CD	46	1,596.00	78,108.00	0.00%	78,108.00
1.1.6	Accessory						
	SWITCH-V5H2	PCIe 3.0 Switch(AC/240V/DC,8GB Cache,16 Port,with 16*Quadwire 40 Gb/s Parallel AOC for PCIe 3.0,SWE1500008)	2	11,472.00	22,944.00	0.00%	22,944.00

	SN2F01FCPC	Patch Cont.DLC/PC,DLC/PC,Multi- mode,3m,A1a 2.2mm,42mm DLC,OM3 bending insensitive	52	14.00	1,288.00	0.00%	1,288.00
1.1.7 Storage Software							
	65V5-LBASIC-N	Basic Software Suite Unlimited Capacity License (Including OceanStor OS,Device Manager,SmartThin,SmartMotion, SmartQoS,SmartPartition,SmartCa- che,SmartMigration,SmartErase,S- martMulti-tenant and SystemReporter,UltraPath)	1	149,505.00	149,505.00	72.00%	41,861.40
Total of Product							1,600,002.44
1.1.8 Maintenance Support Service							
	02351QH8- 88134ULF-36	OceanStor 18500 V5 Engine(5U,Four Controller,AC240HVDC,4*512GB Cache,32*8Gb FC,48*port 4*12Gb SAS,SPE7300600)-Hi-Care Onsite Premier 24x7x4H Engineer Onsite Service-36Month(s)	4	12855.60	51422.40	0.00%	51,422.40
	02351RYF- 88134ULF-36	800GB SSD SAS Disk Unit(2.5")- Hi-Care Onsite Premier 24x7x4H Engineer Onsite Service- 36Month(s)	266	244.80	70502.40	0.00%	70,502.40
	88034JGX- 88134UH9-36	Basic Software Suite Unlimited Capacity License (Including OceanStor OS,Device Manager,SmartThin,SmartMotion, SmartQoS,SmartPartition,SmartCa- che,SmartMigration,SmartErase,S- martMulti-tenant and SystemReporter,UltraPath)-Hi- Care Application Software Upgrade Support Service- 36Month(s)	1	59626.80	59626.80	0.00%	59,626.80
	8812099165	OceanStor 18500 V5 Installation Service - Engineering	1	143194.69	143194.69	0.00%	143,194.69
Total of Service (3 years)							324,746.29
Total Price							1,924,748.73
Notes:Hi-Care Premier On-Site Service include: 7*24 Technical Assistance Center Access. Access to all new software updates and Online Support. 24*7*4 Hours Onsite Hardware Replacement.							
Payment Terms:							
Comments:							

<p>Noviant is an Authorized Value Added reseller (VAR) of networking products. Products sold by NF are factory new unless otherwise specified. All new products sold by NF carry its own Original Equipment Manufacturer's (OEM) Limited Warranty and software licenses. This Quote is valid for 90 days. Prices and availability is subject to change without notice. Installation and configuration costs are not included in the quoted pricing unless specified. A 20% Restocking Fee applies to all cancelled orders and/or returned products. Special Orders are non-returnable. Buyer is responsible for payment of all applicable taxes and freight charges. Issuance of customer PO against this Quote constitutes acceptance of Noviant Sales Terms conditions.</p>		
<p>I agree to the these terms and conditions.</p>		
Authorized Acceptance:_____	Print Name:_____	Date:_____
Noviant:_____	Print Name:_____	Date:_____

APPENDIX C: TUNING PARAMETERS AND OPTIONS

The following scripts, listed below, were used to set tuning parameters and options:

- ***aio-max-nr.sh*** to change the maximum number of AIO operations to 1048576
- ***nr_requests.sh*** to change `nr_requests` from 128 to 1024 on each Host System for each device
- ***scheduler.sh*** to change the I/O scheduler from `cfq` to `noop` on each Host System, which will result in all incoming I/O requests inserted into a simple, unordered FIFO queue

The scripts described above are included in the Supporting Files (see Appendix A) and listed below.

aio-max-nr.sh

```
echo 1048576 > /proc/sys/fs/aio-max-nr
```

nr_requests.sh

```
echo 4096 >/sys/block/sdb/queue/nr_requests  
echo 4096 >/sys/block/sdc/queue/nr_requests  
echo 4096 >/sys/block/sdd/queue/nr_requests  
echo 4096 >/sys/block/sde/queue/nr_requests  
echo 4096 >/sys/block/sdf/queue/nr_requests  
echo 4096 >/sys/block/sdg/queue/nr_requests  
echo 4096 >/sys/block/sdh/queue/nr_requests  
echo 4096 >/sys/block/sdi/queue/nr_requests  
echo 4096 >/sys/block/sdj/queue/nr_requests  
echo 4096 >/sys/block/sdk/queue/nr_requests  
echo 4096 >/sys/block/sdl/queue/nr_requests  
echo 4096 >/sys/block/sdm/queue/nr_requests  
echo 4096 >/sys/block/sdn/queue/nr_requests  
echo 4096 >/sys/block/sdo/queue/nr_requests  
echo 4096 >/sys/block/sdp/queue/nr_requests  
echo 4096 >/sys/block/sdq/queue/nr_requests  
echo 4096 >/sys/block/sdr/queue/nr_requests  
echo 4096 >/sys/block/sds/queue/nr_requests  
echo 4096 >/sys/block/sdt/queue/nr_requests  
echo 4096 >/sys/block/sdu/queue/nr_requests  
echo 4096 >/sys/block/sdv/queue/nr_requests  
echo 4096 >/sys/block/sdw/queue/nr_requests  
echo 4096 >/sys/block/sdx/queue/nr_requests  
echo 4096 >/sys/block/sdy/queue/nr_requests  
echo 4096 >/sys/block/sdz/queue/nr_requests  
echo 4096 >/sys/block/sdaa/queue/nr_requests  
echo 4096 >/sys/block/sdab/queue/nr_requests  
echo 4096 >/sys/block/sdac/queue/nr_requests  
echo 4096 >/sys/block/sdad/queue/nr_requests  
echo 4096 >/sys/block/sdae/queue/nr_requests  
echo 4096 >/sys/block/sdaf/queue/nr_requests  
echo 4096 >/sys/block/sdag/queue/nr_requests  
echo 4096 >/sys/block/sdah/queue/nr_requests  
echo 4096 >/sys/block/sdai/queue/nr_requests
```

```
echo 4096 >/sys/block/sdaj/queue/nr_requests
echo 4096 >/sys/block/sdak/queue/nr_requests
echo 4096 >/sys/block/sdal/queue/nr_requests
echo 4096 >/sys/block/sdam/queue/nr_requests
echo 4096 >/sys/block/sdan/queue/nr_requests
echo 4096 >/sys/block/sdao/queue/nr_requests
echo 4096 >/sys/block/sdap/queue/nr_requests
echo 4096 >/sys/block/sdaq/queue/nr_requests
echo 4096 >/sys/block/sdar/queue/nr_requests
echo 4096 >/sys/block/sdas/queue/nr_requests
echo 4096 >/sys/block/sdat/queue/nr_requests
echo 4096 >/sys/block/sdau/queue/nr_requests
echo 4096 >/sys/block/sdav/queue/nr_requests
echo 4096 >/sys/block/sdaw/queue/nr_requests
echo 4096 >/sys/block/sdax/queue/nr_requests
echo 4096 >/sys/block/sday/queue/nr_requests
echo 4096 >/sys/block/sdaz/queue/nr_requests
echo 4096 >/sys/block/sdba/queue/nr_requests
echo 4096 >/sys/block/sdbb/queue/nr_requests
echo 4096 >/sys/block/sdbc/queue/nr_requests
echo 4096 >/sys/block/sdbd/queue/nr_requests
echo 4096 >/sys/block/sdbe/queue/nr_requests
echo 4096 >/sys/block/sdbf/queue/nr_requests
echo 4096 >/sys/block/sdbg/queue/nr_requests
echo 4096 >/sys/block/sdbh/queue/nr_requests
echo 4096 >/sys/block/sdbi/queue/nr_requests
echo 4096 >/sys/block/sdbj/queue/nr_requests
echo 4096 >/sys/block/sdbk/queue/nr_requests
echo 4096 >/sys/block/sdbl/queue/nr_requests
echo 4096 >/sys/block/sdbm/queue/nr_requests
```

- ***scheduler.sh***

```
echo noop >/sys/block/sdb/queue/scheduler
echo noop >/sys/block/sdc/queue/scheduler
echo noop >/sys/block/sdd/queue/scheduler
echo noop >/sys/block/sde/queue/scheduler
echo noop >/sys/block/sdf/queue/scheduler
echo noop >/sys/block/sgd/queue/scheduler
echo noop >/sys/block/sdh/queue/scheduler
echo noop >/sys/block/sdi/queue/scheduler
echo noop >/sys/block/sdj/queue/scheduler
echo noop >/sys/block/sdk/queue/scheduler
echo noop >/sys/block/sdl/queue/scheduler
echo noop >/sys/block/sdm/queue/scheduler
echo noop >/sys/block/sdn/queue/scheduler
echo noop >/sys/block/sdo/queue/scheduler
echo noop >/sys/block/sdp/queue/scheduler
echo noop >/sys/block/sdq/queue/scheduler
echo noop >/sys/block/sdr/queue/scheduler
echo noop >/sys/block/sds/queue/scheduler
echo noop >/sys/block/sdt/queue/scheduler
echo noop >/sys/block/sdu/queue/scheduler
echo noop >/sys/block/sdv/queue/scheduler
echo noop >/sys/block/sdw/queue/scheduler
echo noop >/sys/block/sdx/queue/scheduler
echo noop >/sys/block/sdy/queue/scheduler
echo noop >/sys/block/sdz/queue/scheduler
echo noop >/sys/block/sdaa/queue/scheduler
echo noop >/sys/block/sdab/queue/scheduler
echo noop >/sys/block/sdac/queue/scheduler
```

```
echo noop >/sys/block/sdad/queue/scheduler
echo noop >/sys/block/sdae/queue/scheduler
echo noop >/sys/block/sdaf/queue/scheduler
echo noop >/sys/block/sdag/queue/scheduler
echo noop >/sys/block/sdah/queue/scheduler
echo noop >/sys/block/sdai/queue/scheduler
echo noop >/sys/block/sdaj/queue/scheduler
echo noop >/sys/block/sdak/queue/scheduler
echo noop >/sys/block/sdal/queue/scheduler
echo noop >/sys/block/sdam/queue/scheduler
echo noop >/sys/block/sdan/queue/scheduler
echo noop >/sys/block/sdao/queue/scheduler
echo noop >/sys/block/sdap/queue/scheduler
echo noop >/sys/block/sdaq/queue/scheduler
echo noop >/sys/block/sdar/queue/scheduler
echo noop >/sys/block/sdas/queue/scheduler
echo noop >/sys/block/sdat/queue/scheduler
echo noop >/sys/block/sdau/queue/scheduler
echo noop >/sys/block/sdav/queue/scheduler
echo noop >/sys/block/sdaw/queue/scheduler
echo noop >/sys/block/sdax/queue/scheduler
echo noop >/sys/block/sday/queue/scheduler
echo noop >/sys/block/sdaz/queue/scheduler
echo noop >/sys/block/sdba/queue/scheduler
echo noop >/sys/block/sdbb/queue/scheduler
echo noop >/sys/block/sdbc/queue/scheduler
echo noop >/sys/block/sdbd/queue/scheduler
echo noop >/sys/block/sdbe/queue/scheduler
echo noop >/sys/block/sdbf/queue/scheduler
echo noop >/sys/block/sdbg/queue/scheduler
echo noop >/sys/block/sdbh/queue/scheduler
echo noop >/sys/block/sdbi/queue/scheduler
echo noop >/sys/block/sdbj/queue/scheduler
echo noop >/sys/block/sdbk/queue/scheduler
echo noop >/sys/block/sdbl/queue/scheduler
echo noop >/sys/block/sdbm/queue/scheduler
```

APPENDIX D: STORAGE CONFIGURATION CREATION

Environment

First, the CLI commands from the following command file are copied and pasted into the OceanStor 18500 V5 CLI window. These commands are executed on one of the Host Systems.

- ***mklnun.txt***

Next, the following shell script is executed on one of the Host Systems.

- ***mkvolume.sh***

Step 1 - Create Disk Domains, Storage Pools, LUNs

The ***mklnun.txt*** command file, listed below, includes all the CLI commands to perform the following actions:

- Create 16 disk domains
- Create 16 storage pools
- Create 64 LUNs
- Create one LUN group
- Add the 64 LUNs to the LUN group

The command file described above is included in the Supporting Files (see Appendix A) and listed below.

mklnun.txt

```
create disk_domain name=dd00 disk_list=DAE000.0-17 tier0_hotspare_strategy=low
  disk_domain_id=0
create disk_domain name=dd01 disk_list=DAE004.0-17 tier0_hotspare_strategy=low
  disk_domain_id=1
create disk_domain name=dd02 disk_list=DAE020.0-17 tier0_hotspare_strategy=low
  disk_domain_id=2
create disk_domain name=dd03 disk_list=DAE024.0-17 tier0_hotspare_strategy=low
  disk_domain_id=3
create disk_domain name=dd04 disk_list=DAE100.0-17 tier0_hotspare_strategy=low
  disk_domain_id=4
create disk_domain name=dd05 disk_list=DAE104.0-17 tier0_hotspare_strategy=low
  disk_domain_id=5
create disk_domain name=dd06 disk_list=DAE120.0-17 tier0_hotspare_strategy=low
  disk_domain_id=6
create disk_domain name=dd07 disk_list=DAE124.0-17 tier0_hotspare_strategy=low
  disk_domain_id=7
create disk_domain name=dd08 disk_list=DAE200.0-17 tier0_hotspare_strategy=low
  disk_domain_id=8
create disk_domain name=dd09 disk_list=DAE204.0-17 tier0_hotspare_strategy=low
  disk_domain_id=9
create disk_domain name=dd10 disk_list=DAE220.0-17 tier0_hotspare_strategy=low
  disk_domain_id=10
create disk_domain name=dd11 disk_list=DAE224.0-17 tier0_hotspare_strategy=low
  disk_domain_id=11
create disk_domain name=dd12 disk_list=DAE300.0-17 tier0_hotspare_strategy=low
  disk_domain_id=12
```

```
create disk_domain name=dd13 disk_list=DAE304.0-17 tier0_hotspare_strategy=low
  disk_domain_id=13
create disk_domain name=dd14 disk_list=DAE320.0-17 tier0_hotspare_strategy=low
  disk_domain_id=14
create disk_domain name=dd15 disk_list=DAE324.0-17 tier0_hotspare_strategy=low
  disk_domain_id=15

create storage_pool name=sp00 disk_type=SSD capacity=6705GB raid_level=RAID10
  pool_id=0 disk_domain_id=0
create storage_pool name=sp01 disk_type=SSD capacity=6705GB raid_level=RAID10
  pool_id=1 disk_domain_id=1
create storage_pool name=sp02 disk_type=SSD capacity=6705GB raid_level=RAID10
  pool_id=2 disk_domain_id=2
create storage_pool name=sp03 disk_type=SSD capacity=6705GB raid_level=RAID10
  pool_id=3 disk_domain_id=3
create storage_pool name=sp04 disk_type=SSD capacity=6705GB raid_level=RAID10
  pool_id=4 disk_domain_id=4
create storage_pool name=sp05 disk_type=SSD capacity=6705GB raid_level=RAID10
  pool_id=5 disk_domain_id=5
create storage_pool name=sp06 disk_type=SSD capacity=6705GB raid_level=RAID10
  pool_id=6 disk_domain_id=6
create storage_pool name=sp07 disk_type=SSD capacity=6705GB raid_level=RAID10
  pool_id=7 disk_domain_id=7
create storage_pool name=sp08 disk_type=SSD capacity=6705GB raid_level=RAID10
  pool_id=8 disk_domain_id=8
create storage_pool name=sp09 disk_type=SSD capacity=6705GB raid_level=RAID10
  pool_id=9 disk_domain_id=9
create storage_pool name=sp10 disk_type=SSD capacity=6705GB raid_level=RAID10
  pool_id=10 disk_domain_id=10
create storage_pool name=sp11 disk_type=SSD capacity=6705GB raid_level=RAID10
  pool_id=11 disk_domain_id=11
create storage_pool name=sp12 disk_type=SSD capacity=6705GB raid_level=RAID10
  pool_id=12 disk_domain_id=12
create storage_pool name=sp13 disk_type=SSD capacity=6705GB raid_level=RAID10
  pool_id=13 disk_domain_id=13
create storage_pool name=sp14 disk_type=SSD capacity=6705GB raid_level=RAID10
  pool_id=14 disk_domain_id=14
create storage_pool name=sp15 disk_type=SSD capacity=6705GB raid_level=RAID10
  pool_id=15 disk_domain_id=15

create lun name=lun_sp00 lun_id_list=0-3 pool_id=0 capacity=1674GB
create lun name=lun_sp01 lun_id_list=4-7 pool_id=1 capacity=1674GB
create lun name=lun_sp02 lun_id_list=8-11 pool_id=2 capacity=1674GB
create lun name=lun_sp03 lun_id_list=12-15 pool_id=3 capacity=1674GB
create lun name=lun_sp04 lun_id_list=16-19 pool_id=4 capacity=1674GB
create lun name=lun_sp05 lun_id_list=20-23 pool_id=5 capacity=1674GB
create lun name=lun_sp06 lun_id_list=24-27 pool_id=6 capacity=1674GB
create lun name=lun_sp07 lun_id_list=28-31 pool_id=7 capacity=1674GB
create lun name=lun_sp08 lun_id_list=32-35 pool_id=8 capacity=1674GB
create lun name=lun_sp09 lun_id_list=36-39 pool_id=9 capacity=1674GB
create lun name=lun_sp10 lun_id_list=40-43 pool_id=10 capacity=1674GB
create lun name=lun_sp11 lun_id_list=44-47 pool_id=11 capacity=1674GB
create lun name=lun_sp12 lun_id_list=48-51 pool_id=12 capacity=1674GB
create lun name=lun_sp13 lun_id_list=52-55 pool_id=13 capacity=1674GB
create lun name=lun_sp14 lun_id_list=56-59 pool_id=14 capacity=1674GB
create lun name=lun_sp15 lun_id_list=60-63 pool_id=15 capacity=1674GB

create lun_group name=lg0 lun_group_id=0
add lun_group lun lun_group_id=0 lun_id_list=0-63
```

Step 2 - Create Mapping View, Host Group and Host

The *mk lun.txt* command file, listed below, includes all the CLI commands to perform the following actions:

- Create 4 hosts
- Create a host group
- Create a mapping view
- Add the 4 hosts to the host group
- Add the host group and the LUN group to the mapping view
- Add the FC port's WWN to the 4 hosts

The command file described above is included in the Supporting Files (see Appendix A) and listed below.

mk lun.txt

```
create host name=host0 operating_system=Linux host_id=0
create host name=host1 operating_system=Linux host_id=1
create host name=host2 operating_system=Linux host_id=2
create host name=host3 operating_system=Linux host_id=3
create host_group name=hg0 host_group_id=0 host_id_list=0-3

create mapping_view name=mv1 mapping_view_id=1 lun_group_id=0 host_group_id=0

add host initiator host_id=0 initiator_type=FC wwn=2100000e1e1807b0
add host initiator host_id=0 initiator_type=FC wwn=2100000e1e1807b1
add host initiator host_id=0 initiator_type=FC wwn=2100000e1e1aa1e0
add host initiator host_id=0 initiator_type=FC wwn=2100000e1e1aa1e1
add host initiator host_id=0 initiator_type=FC wwn=2100000e1e1c2450
add host initiator host_id=0 initiator_type=FC wwn=2100000e1e1c2451
add host initiator host_id=0 initiator_type=FC wwn=2100000e1e1c2600
add host initiator host_id=0 initiator_type=FC wwn=2100000e1e1c2601
add host initiator host_id=0 initiator_type=FC wwn=2100000e1e1c2800
add host initiator host_id=0 initiator_type=FC wwn=2100000e1e1c2801
add host initiator host_id=0 initiator_type=FC wwn=2100000e1e1c7430
add host initiator host_id=0 initiator_type=FC wwn=2100000e1e1c7431
add host initiator host_id=0 initiator_type=FC wwn=2100000e1e23acd0
add host initiator host_id=0 initiator_type=FC wwn=2100000e1e23acd1
add host initiator host_id=0 initiator_type=FC wwn=2100000e1e28a9b0
add host initiator host_id=0 initiator_type=FC wwn=2100000e1e28a9b1
add host initiator host_id=0 initiator_type=FC wwn=2100000e1e2a1c10
add host initiator host_id=0 initiator_type=FC wwn=2100000e1e2a1c11
add host initiator host_id=0 initiator_type=FC wwn=21000024ff17df38
add host initiator host_id=0 initiator_type=FC wwn=21000024ff17df39
add host initiator host_id=0 initiator_type=FC wwn=21000024ff17dff4
add host initiator host_id=0 initiator_type=FC wwn=21000024ff553e1e
add host initiator host_id=0 initiator_type=FC wwn=21000024ff553e1f
add host initiator host_id=0 initiator_type=FC wwn=21000024ff2b0e74
add host initiator host_id=0 initiator_type=FC wwn=21000024ff2b0e75

add host initiator host_id=1 initiator_type=FC wwn=21000024ff17dff5
add host initiator host_id=1 initiator_type=FC wwn=21000024ff17e0ba
add host initiator host_id=1 initiator_type=FC wwn=21000024ff17e0bb
add host initiator host_id=1 initiator_type=FC wwn=21000024ff17e0bc
add host initiator host_id=1 initiator_type=FC wwn=21000024ff17e0bd
add host initiator host_id=1 initiator_type=FC wwn=21000024ff369d90
```

```
add host initiator host_id=1 initiator_type=FC wwn=21000024ff369d91
add host initiator host_id=1 initiator_type=FC wwn=21000024ff37203c
add host initiator host_id=1 initiator_type=FC wwn=21000024ff37203d
add host initiator host_id=1 initiator_type=FC wwn=21000024ff3a3d5c
add host initiator host_id=1 initiator_type=FC wwn=21000024ff3a3d5d
add host initiator host_id=1 initiator_type=FC wwn=21000024ff3cc4ca
add host initiator host_id=1 initiator_type=FC wwn=21000024ff3cc4cb
add host initiator host_id=1 initiator_type=FC wwn=21000024ff4b81fc
add host initiator host_id=1 initiator_type=FC wwn=21000024ff4b81fd
add host initiator host_id=1 initiator_type=FC wwn=21000024ff4b82ea
add host initiator host_id=1 initiator_type=FC wwn=21000024ff4b82eb
add host initiator host_id=1 initiator_type=FC wwn=21000024ff5439d6
add host initiator host_id=1 initiator_type=FC wwn=21000024ff5439d7
add host initiator host_id=1 initiator_type=FC wwn=21000024ff543be2
add host initiator host_id=1 initiator_type=FC wwn=21000024ff543be3
add host initiator host_id=1 initiator_type=FC wwn=21000024ff4b8216
add host initiator host_id=1 initiator_type=FC wwn=21000024ff4b8217
add host initiator host_id=1 initiator_type=FC wwn=21000024ff90188c
add host initiator host_id=1 initiator_type=FC wwn=21000024ff90188d

add host initiator host_id=2 initiator_type=FC wwn=21000024ff5c364e
add host initiator host_id=2 initiator_type=FC wwn=21000024ff5c364f
add host initiator host_id=2 initiator_type=FC wwn=21000024ff5f8bd0
add host initiator host_id=2 initiator_type=FC wwn=21000024ff5f8bd1
add host initiator host_id=2 initiator_type=FC wwn=21000024ff5f8c1e
add host initiator host_id=2 initiator_type=FC wwn=21000024ff5f8c1f
add host initiator host_id=2 initiator_type=FC wwn=21000024ff756d78
add host initiator host_id=2 initiator_type=FC wwn=21000024ff756d79
add host initiator host_id=2 initiator_type=FC wwn=21000024ff7d02ac
add host initiator host_id=2 initiator_type=FC wwn=21000024ff7d02ad
add host initiator host_id=2 initiator_type=FC wwn=21000024ff7ea0fa
add host initiator host_id=2 initiator_type=FC wwn=21000024ff7ea0fb
add host initiator host_id=2 initiator_type=FC wwn=21000024ff7f2cf2
add host initiator host_id=2 initiator_type=FC wwn=21000024ff7f2cf3
add host initiator host_id=2 initiator_type=FC wwn=21000024ff7f3f7e
add host initiator host_id=2 initiator_type=FC wwn=21000024ff7f3f7f
add host initiator host_id=2 initiator_type=FC wwn=21000024ff7f3fd6
add host initiator host_id=2 initiator_type=FC wwn=21000024ff7f3fd7
add host initiator host_id=2 initiator_type=FC wwn=21000024ff7f42b8
add host initiator host_id=2 initiator_type=FC wwn=21000024ff1bdfe2
add host initiator host_id=2 initiator_type=FC wwn=21000024ff1bdfe3
add host initiator host_id=2 initiator_type=FC wwn=21000024ff438098
add host initiator host_id=2 initiator_type=FC wwn=21000024ff438099

add host initiator host_id=3 initiator_type=FC wwn=21000024ff7f42b9
add host initiator host_id=3 initiator_type=FC wwn=21000024ff7f431a
add host initiator host_id=3 initiator_type=FC wwn=21000024ff7f431b
add host initiator host_id=3 initiator_type=FC wwn=21000024ff7f78fe
add host initiator host_id=3 initiator_type=FC wwn=21000024ff7f78ff
add host initiator host_id=3 initiator_type=FC wwn=21000024ff7f789a
add host initiator host_id=3 initiator_type=FC wwn=21000024ff7f789b
add host initiator host_id=3 initiator_type=FC wwn=21000024ff7f78ca
add host initiator host_id=3 initiator_type=FC wwn=21000024ff7f78cb
add host initiator host_id=3 initiator_type=FC wwn=21000024ff7f78aba
add host initiator host_id=3 initiator_type=FC wwn=21000024ff7f78abb
add host initiator host_id=3 initiator_type=FC wwn=21000024ff7fb716
add host initiator host_id=3 initiator_type=FC wwn=21000024ff7fb717
add host initiator host_id=3 initiator_type=FC wwn=21000024ff7fb902
add host initiator host_id=3 initiator_type=FC wwn=21000024ff7fb903
add host initiator host_id=3 initiator_type=FC wwn=21000024ff899b12
add host initiator host_id=3 initiator_type=FC wwn=21000024ff899b13
add host initiator host_id=3 initiator_type=FC wwn=21000024ff536a85
```

```
add host initiator host_id=3 initiator_type=FC wwn=21000024ff536a84
```

Step 3 - Create Volumes on the Host Systems

The ***mkvolume.sh*** shell script, listed below, is invoked on the master Host Systems to perform the following actions:

- Create 64 physical volumes
- Create a volume group for the 64 physical volumes
- Create 18 Logical Volumes for ASU-1
- Create 18 Logical Volumes for ASU-2
- Create 2 Logical Volumes for ASU-3

The shell script described above is included in the Supporting Files (see Appendix A) and listed below.

mkvolume.sh

```
pvcreate /dev/sdb  
pvcreate /dev/sdc  
pvcreate /dev/sdd  
pvcreate /dev/sde  
pvcreate /dev/sdf  
pvcreate /dev/sdg  
pvcreate /dev/sdh  
pvcreate /dev/sdi  
pvcreate /dev/sdj  
pvcreate /dev/sdk  
pvcreate /dev/sdl  
pvcreate /dev/sdm  
pvcreate /dev/sdn  
pvcreate /dev/sdo  
pvcreate /dev/sdp  
pvcreate /dev/sdq  
pvcreate /dev/sdr  
pvcreate /dev/sds  
pvcreate /dev/sdt  
pvcreate /dev/sdu  
pvcreate /dev/sdv  
pvcreate /dev/sdw  
pvcreate /dev/sdx  
pvcreate /dev/sdy  
pvcreate /dev/sdz  
pvcreate /dev/sdaa  
pvcreate /dev/sdab  
pvcreate /dev/sdac  
pvcreate /dev/sdad  
pvcreate /dev/sdae  
pvcreate /dev/sdaf  
pvcreate /dev/sdag  
pvcreate /dev/sdah  
pvcreate /dev/sdai  
pvcreate /dev/sdaj  
pvcreate /dev/sdak  
pvcreate /dev/sdal  
pvcreate /dev/sdam  
pvcreate /dev/sdan  
pvcreate /dev/sdao
```



```
pvcreate /dev/sdap
pvcreate /dev/sdaq
pvcreate /dev/sdar
pvcreate /dev/sdas
pvcreate /dev/sdat
pvcreate /dev/sdau
pvcreate /dev/sdav
pvcreate /dev/sdaw
pvcreate /dev/sdax
pvcreate /dev/sday
pvcreate /dev/sdaz
pvcreate /dev/sdba
pvcreate /dev/sdbb
pvcreate /dev/sdbc
pvcreate /dev/sdbd
pvcreate /dev/sdbe
pvcreate /dev/sdbf
pvcreate /dev/sdbg
pvcreate /dev/sdbh
pvcreate /dev/sdbi
pvcreate /dev/sdbj
pvcreate /dev/sdbk
pvcreate /dev/sdbl
pvcreate /dev/sdbm
```

```
vgcreate vg1 /dev/sdb /dev/sdc /dev/sdd /dev/sde /dev/sdf /dev/sgd /dev/sdh
/dev/sdi /dev/sdj /dev/sdk /dev/sdl /dev/sdm /dev/sdn /dev/sdo /dev/sdp
/dev/sdq /dev/sdr /dev/sds /dev/sdt /dev/sdu /dev/sdv /dev/sdw /dev/sdx
/dev/sdy /dev/sdz /dev/sdaa /dev/sdab /dev/sdac /dev/sdad /dev/sdae /dev/sdaf
/dev/sdag /dev/sdah /dev/sdai /dev/sdaj /dev/sdak /dev/sdal /dev/sdam
/dev/sdan /dev/sdao /dev/sdap /dev/sdaq /dev/sdar /dev/sdas /dev/sdat
/dev/sdau /dev/sdav /dev/sdaw /dev/sdax /dev/sday /dev/sdaz /dev/sdba
/dev/sdbb /dev/sdbc /dev/sdbd /dev/sdbe /dev/sdbf /dev/sdbg /dev/sdbh
/dev/sdbi /dev/sdbj /dev/sdbk /dev/sdbl /dev/sdbm
```

```
lvcreate -n asu101 -i 64 -I 512 -C y -L 2540g vg1
lvcreate -n asu102 -i 64 -I 512 -C y -L 2540g vg1
lvcreate -n asu103 -i 64 -I 512 -C y -L 2540g vg1
lvcreate -n asu104 -i 64 -I 512 -C y -L 2540g vg1
lvcreate -n asu105 -i 64 -I 512 -C y -L 2540g vg1
lvcreate -n asu106 -i 64 -I 512 -C y -L 2540g vg1
lvcreate -n asu107 -i 64 -I 512 -C y -L 2540g vg1
lvcreate -n asu108 -i 64 -I 512 -C y -L 2540g vg1
lvcreate -n asu109 -i 64 -I 512 -C y -L 2540g vg1
lvcreate -n asu110 -i 64 -I 512 -C y -L 2540g vg1
lvcreate -n asu111 -i 64 -I 512 -C y -L 2540g vg1
lvcreate -n asu112 -i 64 -I 512 -C y -L 2540g vg1
lvcreate -n asu113 -i 64 -I 512 -C y -L 2540g vg1
lvcreate -n asu114 -i 64 -I 512 -C y -L 2540g vg1
lvcreate -n asu115 -i 64 -I 512 -C y -L 2540g vg1
lvcreate -n asu116 -i 64 -I 512 -C y -L 2540g vg1
lvcreate -n asu117 -i 64 -I 512 -C y -L 2540g vg1
lvcreate -n asu118 -i 64 -I 512 -C y -L 2540g vg1
```

```
lvcreate -n asu201 -i 64 -I 512 -C y -L 2540g vg1
lvcreate -n asu202 -i 64 -I 512 -C y -L 2540g vg1
lvcreate -n asu203 -i 64 -I 512 -C y -L 2540g vg1
lvcreate -n asu204 -i 64 -I 512 -C y -L 2540g vg1
lvcreate -n asu205 -i 64 -I 512 -C y -L 2540g vg1
lvcreate -n asu206 -i 64 -I 512 -C y -L 2540g vg1
lvcreate -n asu207 -i 64 -I 512 -C y -L 2540g vg1
```

```
lvcreate -n asu208 -i 64 -I 512 -C y -L 2540g vg1
lvcreate -n asu209 -i 64 -I 512 -C y -L 2540g vg1
lvcreate -n asu210 -i 64 -I 512 -C y -L 2540g vg1
lvcreate -n asu211 -i 64 -I 512 -C y -L 2540g vg1
lvcreate -n asu212 -i 64 -I 512 -C y -L 2540g vg1
lvcreate -n asu213 -i 64 -I 512 -C y -L 2540g vg1
lvcreate -n asu214 -i 64 -I 512 -C y -L 2540g vg1
lvcreate -n asu215 -i 64 -I 512 -C y -L 2540g vg1
lvcreate -n asu216 -i 64 -I 512 -C y -L 2540g vg1
lvcreate -n asu217 -i 64 -I 512 -C y -L 2540g vg1
lvcreate -n asu218 -i 64 -I 512 -C y -L 2540g vg1

lvcreate -n asu301 -i 64 -I 512 -C y -L 5080g vg1
lvcreate -n asu302 -i 64 -I 512 -C y -L 5080g vg1
```

APPENDIX E: CONFIGURATION INVENTORY

An inventory of the Tested Storage Configuration was collected during the execution the script *full_run.sh*. It generated the following log file:

- ***profile1_volume.log*** List of configured volumes before the INIT Phase.
- ***profile1_storage.log*** List of configured storage before the INIT Phase.
- ***Profile2_volume.log*** List of configured volumes after TSC restart.
- ***Profile2_storage.log*** List of configured storage after TSC restart.

The above log files are included in the Supporting Files (see Appendix A).

APPENDIX F: WORKLOAD GENERATOR

The ASUs accessed by the SPC-1 workload generator, are defined using the script ***slave_asu.asu***.

The phases of the benchmark are executed using the script ***full_run.sh***. The script pauses at the end of the PERSIST_1 test phase. Once the TSC has been restarted, the PERSIST_2 test phase is executed by pressing ENTER from the console where the script has been invoked.

The above scripts are included in the Supporting Files (see Appendix A) and listed below.

slave_asu.asu

```
ASU=1
OFFSET=0
SIZE=0
DEVICE=/dev/vg1/asu101
DEVICE=/dev/vg1/asu102
DEVICE=/dev/vg1/asu103
DEVICE=/dev/vg1/asu104
DEVICE=/dev/vg1/asu105
DEVICE=/dev/vg1/asu106
DEVICE=/dev/vg1/asu107
DEVICE=/dev/vg1/asu108
DEVICE=/dev/vg1/asu109
DEVICE=/dev/vg1/asu110
DEVICE=/dev/vg1/asu111
DEVICE=/dev/vg1/asu112
DEVICE=/dev/vg1/asu113
DEVICE=/dev/vg1/asu114
DEVICE=/dev/vg1/asu115
DEVICE=/dev/vg1/asu116
DEVICE=/dev/vg1/asu117
DEVICE=/dev/vg1/asu118
```

```
--
ASU=2
OFFSET=0
SIZE=0
DEVICE=/dev/vg1/asu201
DEVICE=/dev/vg1/asu202
DEVICE=/dev/vg1/asu203
DEVICE=/dev/vg1/asu204
DEVICE=/dev/vg1/asu205
DEVICE=/dev/vg1/asu206
DEVICE=/dev/vg1/asu207
DEVICE=/dev/vg1/asu208
DEVICE=/dev/vg1/asu209
DEVICE=/dev/vg1/asu210
DEVICE=/dev/vg1/asu211
DEVICE=/dev/vg1/asu212
DEVICE=/dev/vg1/asu213
DEVICE=/dev/vg1/asu214
DEVICE=/dev/vg1/asu215
DEVICE=/dev/vg1/asu216
```

```
DEVICE=/dev/vg1/asu217
DEVICE=/dev/vg1/asu218
--
ASU=3
OFFSET=0
SIZE=0
DEVICE=/dev/vg1/asu301
DEVICE=/dev/vg1/asu302
```

full_run.sh

```
#!/bin/sh
expect shstorage.tcl > profile1_storage.log
date > profile1_volume.log
lvdisplay >> profile1_volume.log
date >> profile1_volume.log

spc1 -run SPC1_INIT -iops 26000 -storage slave_asu.asu -output
./newtool/spc1_INIT_36k_iops -master 23host.HST
spc1 -run SPC1_VERIFY -iops 1000 -storage slave_asu.asu -output
./newtool/spc1_VERIFY1_1000_iops
spc1 -run SPC1_METRICS -iops 4800200 -storage slave_asu.asu -output
./newtool/spc1_METRICS_4800k_iops -master 23host.HST
spc1 -run SPC1_VERIFY -iops 1000 -storage slave_asu.asu -output
./newtool/spc1_VERIFY2_1000_iops
spc1 -run SPC1_PERSIST_1 -iops 600000 -storage slave_asu.asu -output
./newtool/spc1_PERSIST_600k_iops -master 23host.HST
echo "Power cycle TSC, then Enter to continue"
read

expect shstorage.tcl > profile2_storage.log
date > profile2_volume.log
lvdisplay >> profile2_volume.log
date >> profile2_volume.log
spc1 -run SPC1_PERSIST_2 -iops 600000 -storage slave_asu.asu -output
~/newtool/spc1_PERSIST_600k_iops -master 23host.HST
```