



**SPC BENCHMARK 1™  
FULL DISCLOSURE REPORT**

**IBM CORPORATION  
IBM SYSTEM STORAGE  
SAN VOLUME CONTROLLER v5.1  
*(6-NODE CLUSTER WITH 2 IBM DS8700s)***

**SPC-1 V1.12**

**Submitted for Review: February 1, 2010**

**Submission Identifier: A00087**

**Revised: March 9, 2010**

**First Edition – February 2010**

THE INFORMATION CONTAINED IN THIS DOCUMENT IS DISTRIBUTED ON AN AS IS BASIS WITHOUT ANY WARRANTY EITHER EXPRESS OR IMPLIED. The use of this information or the implementation of any of these techniques is the customer's responsibility and depends on the customer's ability to evaluate and integrate them into the customer's operational environment. While each item has been reviewed by IBM Corporation for accuracy in a specific situation, there is no guarantee that the same or similar results will be obtained elsewhere. Customers attempting to adapt these techniques to their own environment do so at their own risk.

This publication was produced in the United States. IBM Corporation may not offer the products, services, or features discussed in this document in other countries, and the information is subject to change with notice. Consult your local IBM Corporation representative for information on products and services available in your area.

© Copyright IBM Corporation 2010. All rights reserved.

Permission is hereby granted to reproduce this document in whole or in part, provided the copyright notice as printed above is set forth in full text on the title page of each item reproduced.

**Trademarks**

SPC Benchmark-1, SPC-1, SPC-1 IOPS, and SPC-1 LRT are trademarks of the Storage Performance Council. IBM, the IBM logo, and System Storage are trademarks of IBM Corporation in the United States and other countries. All other brands, trademarks, and product names are the property of their respective owners.

## Table of Contents

<b>Audit Certification</b> .....	<b>vii</b>
<b>Audit Certification (cont.)</b> .....	<b>viii</b>
<b>Letter of Good Faith</b> .....	<b>ix</b>
<b>Executive Summary</b> .....	<b>10</b>
<b>Test Sponsor and Contact Information</b> .....	<b>10</b>
<b>Revision Information and Key Dates</b> .....	<b>10</b>
<b>Tested Storage Product (TSP) Description</b> .....	<b>11</b>
<b>Summary of Results</b> .....	<b>11</b>
<b>Storage Capacities, Relationships, and Utilization</b> .....	<b>12</b>
<b>Response Time - Throughput Curve</b> .....	<b>13</b>
<b>Response Time - Throughput Data</b> .....	<b>13</b>
<b>Priced Storage Configuration Pricing</b> .....	<b>14</b>
<b>Differences between the Tested Storage Configuration (TSC) and Priced Storage Configuration</b> .....	<b>15</b>
<b>Benchmark Configuration (BC)/Tested Storage Configuration (TSC)/ Priced Storage Configuration Diagram</b> .....	<b>15</b>
<b>Benchmark Configuration (BC)/Tested Storage Configuration (TSC)/ Priced Storage Configuration Components</b> .....	<b>16</b>
<b>Configuration Information</b> .....	<b>17</b>
<b>Benchmark Configuration (BC)/Tested Storage Configuration (TSC) Diagram</b> .....	<b>17</b>
<b>Storage Network Configuration</b> .....	<b>17</b>
<b>Host System and Tested Storage Configuration (TSC) Table of Components</b> .....	<b>17</b>
<b>Customer Tunable Parameters and Options</b> .....	<b>18</b>
<b>Tested Storage Configuration (TSC) Description</b> .....	<b>18</b>
<b>SPC-1 Workload Generator Storage Configuration</b> .....	<b>18</b>
<b>SPC-1 Data Repository</b> .....	<b>19</b>
<b>Storage Capacities and Relationships</b> .....	<b>19</b>
SPC-1 Storage Capacities .....	<b>19</b>
SPC-1 Storage Hierarchy Ratios .....	<b>19</b>
SPC-1 Storage Capacities and Relationships Illustration .....	<b>20</b>
<b>Logical Volume Capacity and ASU Mapping</b> .....	<b>20</b>
<b>Storage Capacity Utilization</b> .....	<b>21</b>
<b>SPC-1 Benchmark Execution Results</b> .....	<b>22</b>
<b>SPC-1 Tests, Test Phases, and Test Runs</b> .....	<b>22</b>
<b>Primary Metrics Test - Sustainability Test Phase</b> .....	<b>23</b>
SPC-1 Workload Generator Input Parameters .....	<b>23</b>

Sustainability Test Results File .....	23
Sustainability – Data Rate Distribution Data ( <i>MB/second</i> ).....	24
Sustainability – Data Rate Distribution Graph .....	25
Sustainability – I/O Request Throughput Distribution Graph .....	27
Sustainability – Average Response Time (ms) Distribution Data .....	28
Sustainability – Average Response Time (ms) Distribution Graph .....	29
Sustainability – Response Time Frequency Distribution Data .....	30
Sustainability – Response Time Frequency Distribution Graph .....	30
Sustainability – Measured Intensity Multiplier and Coefficient of Variation.....	31
<b>Primary Metrics Test – IOPS Test Phase.....</b>	<b>32</b>
SPC-1 Workload Generator Input Parameters .....	32
IOPS Test Results File.....	32
IOPS Test Run – I/O Request Throughput Distribution Data .....	33
IOPS Test Run – I/O Request Throughput Distribution Graph.....	33
IOPS Test Run – Average Response Time (ms) Distribution Data.....	34
IOPS Test Run – Average Response Time (ms) Distribution Graph .....	34
IOPS Test Run – Response Time Frequency Distribution Data .....	35
IOPS Test Run –Response Time Frequency Distribution Graph.....	35
IOPS Test Run – I/O Request Information.....	36
IOPS Test Run – Measured Intensity Multiplier and Coefficient of Variation.....	36
<b>Primary Metrics Test – Response Time Ramp Test Phase .....</b>	<b>37</b>
SPC-1 Workload Generator Input Parameters .....	37
Response Time Ramp Test Results File.....	37
Response Time Ramp Distribution (IOPS) Data.....	38
Response Time Ramp Distribution (IOPS) Graph .....	39
SPC-1 LRT™ Average Response Time (ms) Distribution Data.....	40
SPC-1 LRT™ Average Response Time (ms) Distribution Graph .....	40
SPC-1 LRT™ (10%) – Measured Intensity Multiplier and Coefficient of Variation .....	41
<b>Repeatability Test .....</b>	<b>42</b>
SPC-1 Workload Generator Input Parameters .....	42
Repeatability Test Results File .....	43
Repeatability 1 LRT – I/O Request Throughput Distribution Data.....	44
Repeatability 1 LRT – I/O Request Throughput Distribution Graph .....	44
Repeatability 1 LRT –Average Response Time (ms) Distribution Data .....	45
Repeatability 1 LRT –Average Response Time (ms) Distribution Graph.....	45
Repeatability 1 IOPS – I/O Request Throughput Distribution Data .....	46
Repeatability 1 IOPS – I/O Request Throughput Distribution Graph.....	46
Repeatability 1 IOPS –Average Response Time (ms) Distribution Data.....	47
Repeatability 1 IOPS –Average Response Time (ms) Distribution Graph .....	47

Repeatability 2 LRT – I/O Request Throughput Distribution Data.....	48
Repeatability 2 LRT – I/O Request Throughput Distribution Graph .....	48
Repeatability 2 LRT –Average Response Time (ms) Distribution Data .....	49
Repeatability 2 LRT –Average Response Time (ms) Distribution Graph.....	49
Repeatability 2 IOPS – I/O Request Throughput Distribution Data .....	50
Repeatability 2 IOPS – I/O Request Throughput Distribution Graph.....	50
Repeatability 2 IOPS –Average Response Time (ms) Distribution Data.....	51
Repeatability 2 IOPS –Average Response Time (ms) Distribution Graph .....	51
Repeatability 1 (LRT) Measured Intensity Multiplier and Coefficient of Variation.....	52
Repeatability 1 (IOPS) Measured Intensity Multiplier and Coefficient of Variation ....	52
Repeatability 2 (LRT) Measured Intensity Multiplier and Coefficient of Variation.....	52
Repeatability 2 (IOPS) Measured Intensity Multiplier and Coefficient of Variation ....	53
<b>Data Persistence Test.....</b>	<b>54</b>
SPC-1 Workload Generator Input Parameters .....	54
Data Persistence Test Results File .....	54
Data Persistence Test Results.....	55
<b>Priced Storage Configuration Availability Date.....</b>	<b>56</b>
<b>Pricing Information.....</b>	<b>56</b>
<b>Tested Storage Configuration (TSC) and Priced Storage Configuration Differences.....</b>	<b>56</b>
<b>Anomalies or Irregularities .....</b>	<b>56</b>
<b>Appendix A: SPC-1 Glossary .....</b>	<b>57</b>
“Decimal” ( <i>powers of ten</i> ) Measurement Units.....	57
“Binary” ( <i>powers of two</i> ) Measurement Units.....	57
SPC-1 Data Repository Definitions.....	57
SPC-1 Data Protection Levels .....	58
SPC-1 Test Execution Definitions .....	58
I/O Completion Types.....	60
SPC-1 Test Run Components .....	60
<b>Appendix B: Customer Tunable Parameters and Options.....</b>	<b>61</b>
<b>Appendix C: Tested Storage Configuration (TSC) Creation .....</b>	<b>62</b>
<b>DS8700 Configuration Steps .....</b>	<b>62</b>
Create extent pools.....	62
Create the RAID-10 ranks .....	64
Create the LUNs .....	68
Define presentation of the LUNs .....	73
Configure the second DS8700.....	75

<b>SVC Configuration Steps</b> .....	<b>75</b>
Discover SVC MDisks .....	76
Define SVC VDIsks .....	76
<b>AIX Configuration Steps</b> .....	<b>78</b>
<b>Appendix D: SPC-1 Workload Generator Storage Commands and Parameters</b> .....	<b>80</b>
<b>Primary Metrics Test</b> .....	<b>80</b>
Sustainability .....	80
Ramp 100 Test Run.....	82
Ramp 95 Test Run.....	85
Ramp 90 Test Run.....	87
Ramp 80 Test Run.....	90
Ramp 50 Test Run.....	92
Ramp 10 Test Run.....	95
<b>Repeatability Test</b> .....	<b>98</b>
Repeat1 LRT Test Run Repeat1 IOPS Test Run.....	98
Repeat2 LRT Test Run Repeat2 IOS Test Run .....	100
<b>Persistence Test</b> .....	<b>103</b>
Persistence Test Run 1 .....	103
Persistence Test Run 2 .....	105
<b>Appendix E: SPC-1 Workload Generator Input Parameters</b> .....	<b>109</b>
<b>Primary Metrics Test, Repeatability Test, and Persistence Test Run 1</b> .....	<b>109</b>
runpersist1.sh.....	110
runslaves.sh.....	110
rmslaves.sh.....	111
<b>Persistence Test Run 2</b> .....	<b>112</b>
runpersist2.sh.....	112

## AUDIT CERTIFICATION



Bruce McNutt  
 IBM Corporation  
 650 Harry Road C2 500  
 San Jose, CA 95120

January 29, 2010

The SPC Benchmark 1™ results listed below for the IBM System Storage DS8700 (6 node SVC 5.1 cluster) were produced in compliance with the SPC Benchmark 1™ 1.12 Remote Audit requirements.

SPC Benchmark 1™ 1.12 Results	
Tested Storage Configuration (TSC) Name: IBM System Storage DS8700 (6 node SVC 5.1 cluster)	
Metric	Reported Result
SPC-1 IOPS™	380,489.30
SPC-1 Price-Performance	\$18.83/SPC-1 IOPS™
Total ASU Capacity	97,581,657 GB
Data Protection Level	Protected (Mirroring)
Total TSC Price (including three-year maintenance)	\$7,165,323.19

The following SPC Benchmark 1™ Remote Audit requirements were reviewed and found compliant with 1.12 of the SPC Benchmark 1™ specification:

- A Letter of Good Faith, signed by a senior executive.
- The following Data Repository storage items, based on information supplied by IBM Corporation:
  - ✓ Physical Storage Capacity and requirements.
  - ✓ Configured Storage Capacity and requirements.
  - ✓ Addressable Storage Capacity and requirements.
  - ✓ Capacity of each Logical Volume and requirements.
  - ✓ Capacity of each Application Storage Unit (ASU) and requirements.
- An appropriate diagram of the Benchmark Configuration (BC)/Tested Storage Configuration (TSC).
- Listings and commands to configure the Benchmark Configuration/Tested Storage Configuration, including customer tunable parameters that were changed from default values.
- SPC-1 Workload Generator commands and parameters used for the audited SPC Test Runs.

Storage Performance Council  
 643 Bair Island Road, Suite 103  
 Redwood City, CA 94062  
[AuditService@storageperformance.org](mailto:AuditService@storageperformance.org)  
 650.566.9384

**AUDIT CERTIFICATION (CONT.)**

IBM System Storage DS8700 (6 node SVC 5.1 cluster)  
SPC-1 Audit Certification

Page

- The following Host System requirements, based on information supplied by IBM Corporation:
  - ✓ The type of Host System including the number of processors and main memory.
  - ✓ The presence and version number of the SPC-1 Workload Generator on each Host System.
  - ✓ The TSC boundary within each Host System.
- The Test Results Files and resultant Summary Results Files received from IBM Corporation for each of following were authentic, accurate, and compliant with all of the requirements and constraints of Clauses 4 and 5 of the SPC-1 Benchmark Specification:
  - ✓ Data Persistence Test
  - ✓ Sustainability Test Phase
  - ✓ IOPS Test Phase
  - ✓ Response Time Ramp Test Phase
  - ✓ Repeatability Test
- There were no differences between the Tested Storage Configuration (TSC) used for the benchmark and Priced Storage.
- The submitted pricing information met all of the requirements and constraints of Clause 8 of the SPC-1 Benchmark Specification.
- The Full Disclosure Report (FDR) met all of the requirements in Clause 9 of the SPC-1 Benchmark Specification.
- This successfully audited SPC measurement is not subject to an SPC Confidential Review.

**Audit Notes:**

The Slave JVMs were parted prior to each Test Run and terminated at the completion of each Test Run to address a Java memory allocation issue.

The SPC-2 Persistence Test was approved for use to meet the SPC-1 persistence requirements.

Respectfully,

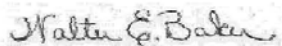

Walter E. Baker  
SPC Auditor

Storage Performance Council  
643 Bair Island Road, Suite 103  
Redwood City, CA 94062  
[AuditService@storageperformance.org](mailto:AuditService@storageperformance.org)  
650.556.9384



**LETTER OF GOOD FAITH**

Vice President and Disk Storage Business Line Executive

IBM Technology & Systems Group  
3039 Central Expressway  
Research Triangle Park, NC 27709

Phone: 1-919-643-6345  
Fax: 1-919-643-2856

January 8, 2010

Mr. Walter E. Baker, SPC Auditor  
Gradient Systems, Inc.  
643 Bair Island Road, Suite 103  
Redwood City, CA 94063

Subject: SPC-1 Letter of Good Faith for the IBM System Storage DS8700 (6-node SVC 5.1 cluster).

IBM Corporation is the SPC-1 Test Sponsor for the above listed product. To the best of our knowledge and belief, the required SPC-1 benchmark results and materials we have submitted for that product are complete, accurate, and in full compliance with Version 1.12 of the SPC-1 benchmark specification.

Our disclosure of the Benchmark configuration and execution of the benchmark includes all items that, to the best of our knowledge and belief, materially affect the reported results, regardless of whether such items are explicitly required to be disclosed by the SPC-1 benchmark specification.

Sincerely,

A handwritten signature in cursive script that reads "Doug Balog".

Doug Balog

## **EXECUTIVE SUMMARY**

### **Test Sponsor and Contact Information**

<b>Test Sponsor and Contact Information</b>	
<b>Test Sponsor Primary Contact</b>	IBM Corporation – <a href="http://www.ibm.com">http://www.ibm.com</a> Bruce McNutt – <a href="mailto:bmcnutt@us.ibm.com">bmcnutt@us.ibm.com</a> 650 Harry Road C2 500 San Jose, CA 95120 Phone: (408) 927-2717 FAX: 0086 28 62905793
<b>Test Sponsor Alternate Contact</b>	IBM Corporation – <a href="http://www.ibm.com">http://www.ibm.com</a> Joe Hyde – <a href="mailto:joehyde@us.ibm.com">joehyde@us.ibm.com</a> 9000 S. Rita Road 9042-2 Tucson, AZ 85744 Phone: (520) 799-4026 FAX: (520) 799-5550
<b>Auditor</b>	Storage Performance Council – <a href="http://www.storageperformance.org">http://www.storageperformance.org</a> Walter E. Baker – <a href="mailto:AuditService@StoragePerformance.org">AuditService@StoragePerformance.org</a> 643 Bair Island Road, Suite 103 Redwood City, CA 94063 Phone: (650) 556-9384 FAX: (650) 556-9385

### **Revision Information and Key Dates**

<b>Revision Information and Key Dates</b>	
<b>SPC-1 Specification revision number</b>	V1.12
<b>SPC-1 Workload Generator revision number</b>	V2.1.0
<b>Date Results were first used publicly</b>	February 1, 2010
<b>Date the FDR was submitted to the SPC</b>	February 1, 2010
<b>Date the revised FDR was submitted to the SPC</b> Tested Storage Product (TSP) name revision for clarification "IBM System Storage DS8700 (4 node with SVC 5.1 cluster)" was revised to: "IBM System Storage SAN Volume Controller v5.1 (6-node cluster with 2 IBM DS8700s)"	March 9, 2010
<b>Date the priced storage configuration is available for shipment to customers</b>	currently available
<b>Date the TSC completed audit certification</b>	January 29, 2010

## Tested Storage Product (TSP) Description

The IBM System Storage SAN Volume Controller (SVC) enables a single point of control for disparate, heterogeneous storage resources to help support improved business application availability and greater resource utilization. SAN Volume Controller is designed to pool storage volumes from IBM and non-IBM storage systems into a single reservoir of capacity for centralized management. SVC Version 5.1, implemented using CF8 nodes as in the present test result, offers 8 Gbps port speeds, 24 GB of cache per node, optional capability (not used in the present test) to incorporate SSD drives, and significantly faster processor technology compared with SVC Version 4.3.

The IBM System Storage DS8000™ series encompasses the flagship disk enterprise storage products in the IBM System Storage portfolio. The DS8700 represents the latest in this series of enterprise disk storage systems designed for high-performance, high-capacity and resiliency. Major new capabilities include IBM POWER6 Processing technology and PCI-e I/O enclosures.

## Summary of Results

SPC-1 Results	
Tested Storage Product (TSP) Name: IBM System Storage SAN Volume Controller v5.1 (6-node cluster with 2 IBM DS8700s)	
Metric	Reported Result
SPC-1 IOPS™	380,489.30
SPC-1 Price-Performance	\$18.83/SPC-1 IOPS™
Total ASU Capacity	97,581.657 GB
Data Protection Level	Protected ( <i>Mirroring</i> )
Total TSC Price (including three-year maintenance)	\$7,165,323.19

**SPC-1 IOPS™** represents the maximum I/O Request Throughput at the 100% load point.

**Total ASU (Application Storage Unit) Capacity** represents the total storage capacity read and written in the course of executing the SPC-1 benchmark.

A **Data Protection Level of Protected** using *Mirroring* configures two or more identical copies of user data.

### Storage Capacities, Relationships, and Utilization

The following diagram and table document the various storage capacities, used in this benchmark, and their relationships, as well as the storage utilization values required to be reported.

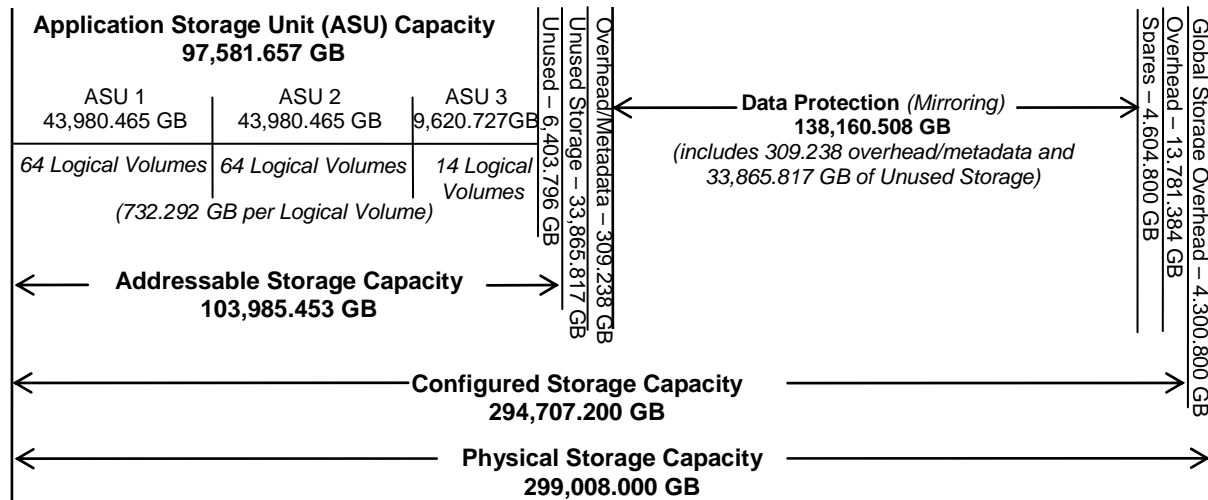

SPC-1 Storage Capacity Utilization	
Application Utilization	32.64%
Protected Application Utilization	67.52%
Unused Storage Ratio	24.79%

**Application Utilization:** Total ASU Capacity (97,581.657 GB) divided by Physical Storage Capacity (299,008.000 GB)

**Protected Application Utilization:** (Total ASU Capacity (97,581.657 GB) plus total Data Protection Capacity (138,160.508 GB) minus unused Data Protection Capacity (33,865.817 GB) divided by Physical Storage Capacity (299,008.000 GB)

**Unused Storage Ratio:** Total Unused Capacity (74,135.43 GB) divided by Physical Storage Capacity (299,008.000 GB) and may not exceed 45%.

Detailed information for the various storage capacities and utilizations is available on pages 19-20 in the Full Disclosure Report.

### Response Time – Throughput Curve

The Response Time-Throughput Curve illustrates the Average Response Time (milliseconds) and I/O Request Throughput at 100%, 95%, 90%, 80%, 50%, and 10% of the workload level used to generate the SPC-1 IOPS™ metric.

The Average Response Time measured at any of the above load points cannot exceed 30 milliseconds or the benchmark measurement is invalid.

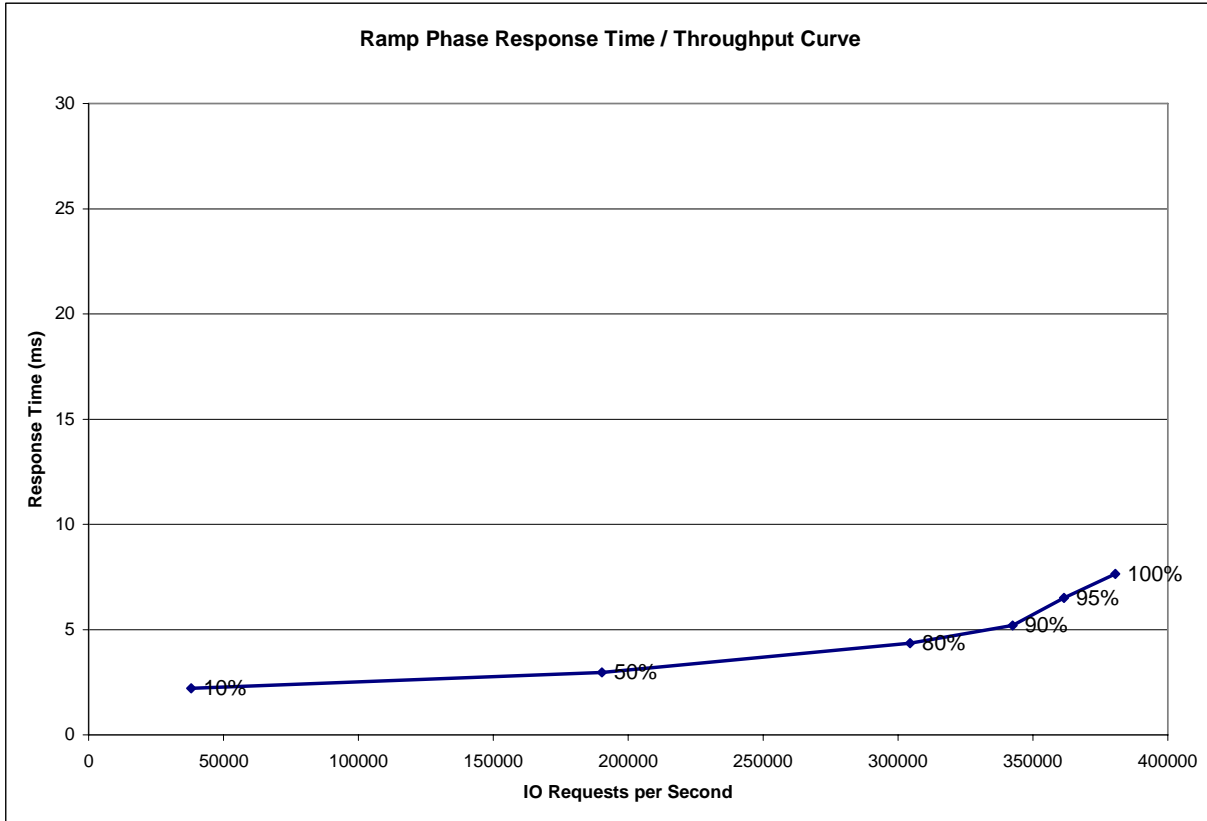

### Response Time – Throughput Data

	10% Load	50% Load	80% Load	90% Load	95% Load	100% Load
<b>I/O Request Throughput</b>	38,047.59	190,253.20	304,422.35	342,453.46	361,491.51	380,489.30
<b>Average Response Time (ms):</b>						
All ASUs	2.20	2.96	4.36	5.20	6.50	7.64
ASU-1	2.84	3.67	5.14	5.94	7.25	8.37
ASU-2	1.99	2.83	4.26	5.05	6.34	7.45
ASU-3	0.95	1.50	2.73	3.68	4.99	6.16
Reads	4.19	5.30	7.04	7.80	9.22	10.36
Writes	0.91	1.44	2.62	3.50	4.74	5.86

## Priced Storage Configuration Pricing

Component	Quantity	Unit Price	Unit Maint	List w/ Maint	% discount	Total Price
2145-CF8 SVC Storage Engine	6	16,500.00	2,616.00	114,696.00	30	80,287.20
8115 UPS	6	1,000.00	1,656.00	15,936.00	30	11,155.20
2805-MC4 Master Console	1	5,994.00	1,272.00	7,266.00	30	5,086.20
5608-WB1 TPC Basic Edition	1	3,399.00	1,359.00	4,758.00	30	3,330.60
SVC Software license (base)						
5939-VC5 up to 150 TB	1	394,490.00	157,796.00	552,286.00	30	386,600.20
7014-T42 19 inch rack	1	5,060.00	888.00	5,948.00	50	2,974.00
8 Gbps fibre channel switch						
2498-B24 w/24 ports enabled, 8 Gbps SFPs	4	15,160.00	1,350.00	66,040.00	20	52,832.00
5605 Short wave 5m fibre channel cable	24	105.00		2,520.00	20	2,016.00
5625 Short wave 25 m fibre channel cable	64	210.00		13,440.00	20	10,752.00
73P-2413 Ethernet switch	1	135.99	30.00	165.99	0	165.99
15S-10102 Ethernet 15 foot cable	11	17.00		187.00	0	187.00
9119-595 5716 2 Gbit P5 595 adapter	32	1,999.00		63,968.00	30	44,777.60
2398-LFA DS8000 Function Authorization	2	763,186.00		1,526,372.00	40	915,823.20
2423-941 System Storage DS8700 (A frame)	2	72,419.00		144,838.00	50	72,419.00
1050 Battery Assembly	6	1,700.00		10,200.00	50	5,100.00
1090 Line Cord (US/LA/AP/Canada)	2	1,900.00		3,800.00	50	1,900.00
1120 Management Console - English Laptop Internal	2	9,160.00		18,320.00	50	9,160.00
1210 Disk Enclosure Pair	8	10,000.00		80,000.00	50	40,000.00
1211 Disk Drive Cable Group 1	2	1,000.00		2,000.00	50	1,000.00
1301 I/O Enclosure Pair PCIE	4	11,780.00		47,120.00	50	23,560.00
1321 PCI-E Cable Group 2	2	4,100.00		8,200.00	50	4,100.00
1711 Release 5 Bundle Family	2	40,000.00		80,000.00	50	40,000.00
2216 146 GB 15K Drive Set (16 drives per set)	16	46,076.00		737,216.00	50	368,608.00
3043 Device Adapter Pair III	8	10,000.00		80,000.00	50	40,000.00
3143 4Gb SW FCP/FICON Adapter PCIE	16	33,920.00		542,720.00	50	271,360.00
4226 384 GB Processor Memory (4-Way)	2	1,176,960.00		2,353,920.00	50	1,176,960.00
4302 4 Way Processor Card	2	80,893.00		161,786.00	50	80,893.00
2423-94E System Storage DS8700 Expansion Unit (B frame)	2	73,500.00		147,000.00	50	73,500.00
1050 Battery Assembly	4	1,700.00		6,800.00	50	3,400.00
1090 Line Cord (US/LA/AP/Canada)	2	1,900.00		3,800.00	50	1,900.00
1210 Disk Enclosure Pair	16	10,000.00		160,000.00	50	80,000.00
1212 Disk Drive Cable Group 2	2	1,900.00		3,800.00	50	1,900.00
1301 I/O Enclosure Pair PCIE	4	11,780.00		47,120.00	50	23,560.00
1322 PCI-E Cable Group 3	2	5,000.00		10,000.00	50	5,000.00
2216 146 GB 15K Drive Set (16 drives per set)	32	46,076.00		1,474,432.00	50	737,216.00
3043 Device Adapter Pair III	8	10,000.00		80,000.00	50	40,000.00
3143 4Gb SW FCP/FICON Adapter PCIE	16	33,920.00		542,720.00	50	271,360.00
2423-94E System Storage DS8700 Expansion Unit (C frame)	2	73,500.00		147,000.00	50	73,500.00
1090 Line Cord (US/LA/AP/Canada)	2	1,900.00		3,800.00	50	1,900.00
1210 Disk Enclosure Pair	16	10,000.00		160,000.00	50	80,000.00
1214 Disk Drive Cable Group 4	2	2,400.00		4,800.00	50	2,400.00
2216 146 GB 15K Drive Set (16 drives per set)	32	46,076.00		1,474,432.00	50	737,216.00
2423-94E System Storage DS8700 Expansion Unit (D frame)	2	73,500.00		147,000.00	50	73,500.00
1090 Line Cord (US/LA/AP/Canada)	2	1,900.00		3,800.00	50	1,900.00
1210 Disk Enclosure Pair	16	10,000.00		160,000.00	50	80,000.00
1214 Disk Drive Cable Group 4	2	2,400.00		4,800.00	50	2,400.00
2216 146 GB 15K Drive Set (16 drives per set)	32	46,076.00		1,474,432.00	50	737,216.00
2423-94E System Storage DS8700 Expansion Unit (E frame)	2	73,500.00		147,000.00	50	73,500.00
1090 Line Cord (US/LA/AP/Canada)	2	1,900.00		3,800.00	50	1,900.00
1210 Disk Enclosure Pair	8	10,000.00		80,000.00	50	40,000.00
1214 Disk Drive Cable Group 4	2	2,400.00		4,800.00	50	2,400.00
2216 146 GB 15K Drive Set (16 drives per set)	16	46,076.00		737,216.00	50	368,608.00
<b>Total Price</b>						<b>7,165,323.19</b>

The above pricing includes hardware maintenance and software support for three years, 7 days per week, 24 hours per day. The hardware maintenance and software support provides the following:

- Acknowledgement of new and existing problems with four (4) hours.
- Onsite present of a qualified maintenance engineer or provision of a customer replaceable part within four (4) hours of the above acknowledgement for any hardware failure that results in an inoperative Price Storage Configuration that can

be remedied by the repair or replacement of a Priced Storage Configuration component.

**Differences between the Tested Storage Configuration (TSC) and Priced Storage Configuration**

There were no differences between the TSC and Priced Storage Configuration.

**Benchmark Configuration (BC)/Tested Storage Configuration (TSC)/Priced Storage Configuration Diagram**

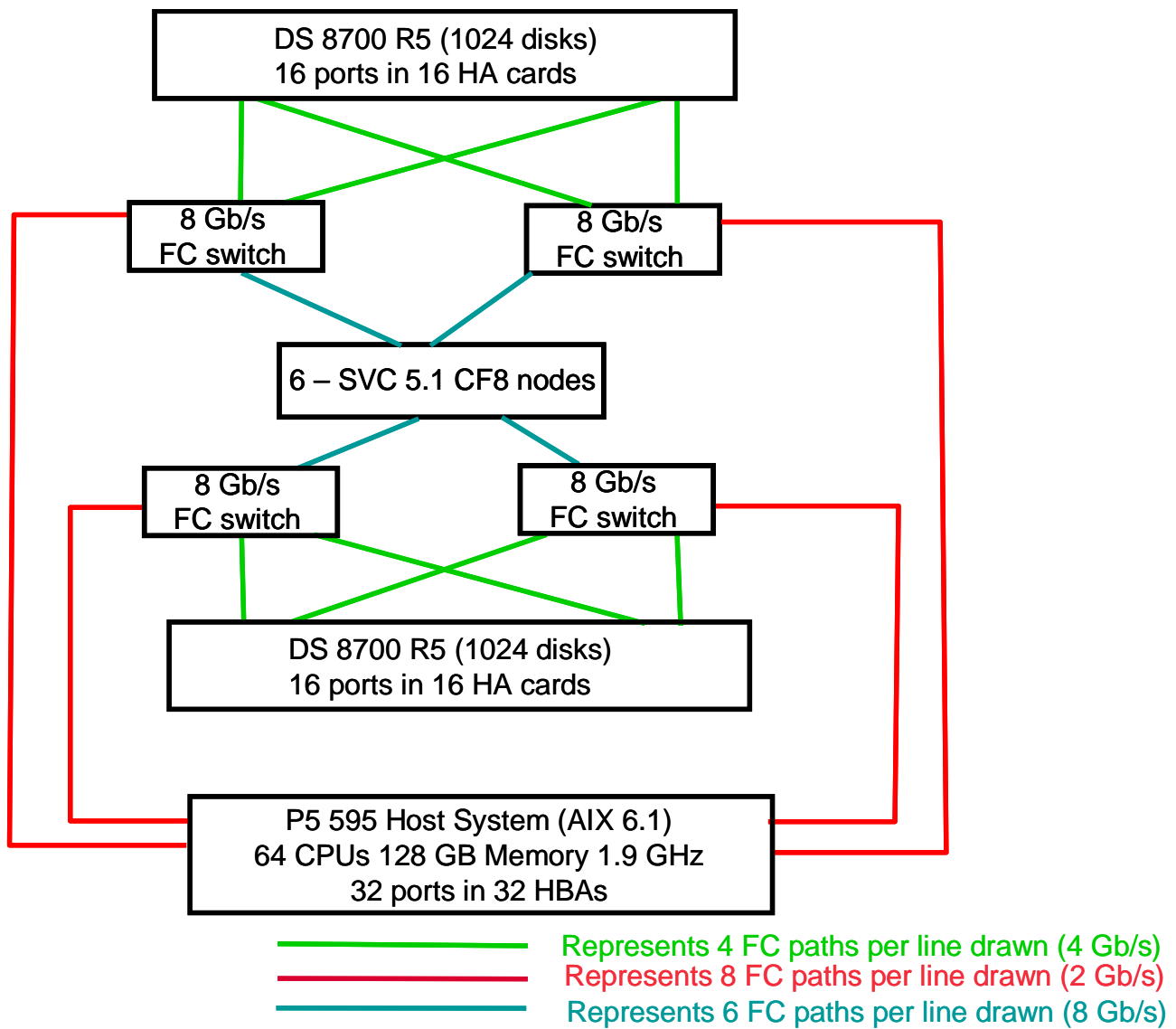

All storage is managed by each SVC node (single image). Each switch has 24 ports enabled, with one zone for node-to-storage traffic and one zone for node-to-host traffic.

### Benchmark Configuration (BC)/Tested Storage Configuration (TSC)/ Priced Storage Configuration Components

Host System:	Tested Storage Configuration (TSC)/ Priced Storage Configuration:
IBM P5 595 Model 9119	32 – 2 Gbit P5 595 HBAs
64 – dual core CPUs, 2 CPUs/POWER5 chip 32 KB L1 cache, 960 KB L2 cache, and 18 MB L3 cache per CPU	<b>IBM System Storage DS8700 (6 node SVC 5.1 cluster):</b> 2 – IBM DS8700 each with: 384 GB memory/cache 16 – 4 Gbit FC front-end physical connections <i>(32 total)</i> 64 – 2 Gbit backend physical connections <i>(128 total)</i> 1024 – 146 GB 15K RPM disk drives <i>(2048 total)</i>
128 GB main memory	
AIX 6.1 TL 03	
PCI-X/RIO	
	6 – IBM SAN Volume Controller nodes each with: 24 GB memory/cache 4 – 8Gbit FC connections
	1 – Master Console
	2 – Management Consoles
	4 – IBM 2498-B24 8 Gbps FC switches
	2 – DS8700 base units
	8 – DS8700 Expansion Units
	6 – UPS



In each of the following sections of this document, the appropriate Full Disclosure Report requirement, from the SPC-1 benchmark specification, is stated in italics followed by the information to fulfill the stated requirement.

## **CONFIGURATION INFORMATION**

### **Benchmark Configuration (BC)/Tested Storage Configuration (TSC) Diagram**

#### **Clause 9.4.3.4.1**

*A one page Benchmark Configuration (BC)/Tested Storage Configuration (TSC) diagram shall be included in the FDR...*

The Benchmark Configuration (BC)/Tested Storage Configuration (TSC) is illustrated on page 15 (*Benchmark Configuration (BC)/Tested Storage Configuration (TSC)/Priced Storage Configuration Diagram*).

### **Storage Network Configuration**

#### **Clause 9.4.3.4.1**

...

5. *If the TSC contains network storage, the diagram will include the network configuration. If a single diagram is not sufficient to illustrate both the Benchmark Configuration and network configuration in sufficient detail, the Benchmark Configuration diagram will include a high-level network illustration as shown in Figure 9-8. In that case, a separate, detailed network configuration diagram will also be included as described in Clause 9.4.3.4.2.*

#### **Clause 9.4.3.4.2**

*If a storage network was configured as a part of the Tested Storage Configuration and the Benchmark Configuration diagram described in Clause 9.4.3.4.1 contains a high-level illustration of the network configuration, the Executive Summary will contain a one page topology diagram of the storage network as illustrated in Figure 9-9.*

The Host System and TSC table of components may be found on page 15 (*Benchmark Configuration (BC)/Tested Storage Configuration (TSC)/Priced Storage Configuration Diagram*).

### **Host System and Tested Storage Configuration (TSC) Table of Components**

#### **Clause 9.4.3.4.3**

*The FDR will contain a table that lists the major components of each Host System and the Tested Storage Configuration (TSC). Table 9-10 specifies the content, format, and appearance of the table.*

The Host System and TSC table of components may be found on page 16 (*Benchmark Configuration (BC)/Tested Storage Configuration (TSC)/Priced Storage Configuration Components*).

## Customer Tunable Parameters and Options

### Clause 9.4.3.5.1

*All Benchmark Configuration (BC) components with customer tunable parameter and options that have been altered from their default values must be listed in the FDR. The FDR entry for each of those components must include both the name of the component and the altered value of the parameter or option. If the parameter name is not self-explanatory to a knowledgeable practitioner, a brief description of the parameter's use must also be included in the FDR entry.*

“Appendix B: Customer Tunable Parameters and Options” on page 61 contains the customer tunable parameters and options that have been altered from their default values for this benchmark.

## Tested Storage Configuration (TSC) Description

### Clause 9.4.3.5.2

*The FDR must include sufficient information to recreate the logical representation of the TSC. In addition to customer tunable parameters and options (Clause 4.2.4.5.3), that information must include, at a minimum:*

- *A diagram and/or description of the following:*
  - *All physical components that comprise the TSC. Those components are also illustrated in the BC Configuration Diagram in Clause 9.2.4.4.1 and/or the Storage Network Configuration Diagram in Clause 9.2.4.4.2.*
  - *The logical representation of the TSC, configured from the above components that will be presented to the Workload Generator.*
- *Listings of scripts used to create the logical representation of the TSC.*
- *If scripts were not used, a description of the process used with sufficient detail to recreate the logical representation of the TSC.*

“Appendix C: Tested Storage Configuration (TSC) Creation” on page 62 contains the detailed information that describes how to create and configure the logical TSC.

## SPC-1 Workload Generator Storage Configuration

### Clause 9.4.3.5.3

*The FDR must include all SPC-1 Workload Generator storage configuration commands and parameters.*

The SPC-1 Workload Generator storage configuration commands and parameters for this measurement appear in “Appendix D: SPC-1 Workload Generator Storage Commands and Parameters” on page 80.

## **SPC-1 DATA REPOSITORY**

This portion of the Full Disclosure Report presents the detailed information that fully documents the various SPC-1 storage capacities and mappings used in the Tested Storage Configuration. “SPC-1 Data Repository Definitions” on page 57 contains definitions of terms specific to the SPC-1 Data Repository.

### **Storage Capacities and Relationships**

#### **Clause 9.4.3.6.1**

*Two tables and an illustration documenting the storage capacities and relationships of the SPC-1 Storage Hierarchy (Clause 2.1) shall be included in the FDR.*

### **SPC-1 Storage Capacities**

<b>SPC-1 Storage Capacities</b>		
<b>Storage Hierarchy Component</b>	<b>Units</b>	<b>Capacity</b>
Total ASU Capacity	Gigabytes (GB)	97,581.657
Addressable Storage Capacity	Gigabytes (GB)	103,985.453
Configured Storage Capacity	Gigabytes (GB)	294,707.200
Physical Storage Capacity	Gigabytes (GB)	299,008.000
Data Protection ( <i>Mirroring</i> )	Gigabytes (GB)	138,160.508
Required Storage ( <i>including spares</i> )	Gigabytes (GB)	19,004.659
Global Storage Overhead	Gigabytes (GB)	4,300.800
Total Unused Storage	Gigabytes (GB)	74,135.43

### **SPC-1 Storage Hierarchy Ratios**

	<b>Addressable Storage Capacity</b>	<b>Configured Storage Capacity</b>	<b>Physical Storage Capacity</b>
<b>Total ASU Capacity</b>	93.84%	33.11%	32.64%
<b>Required for Data Protection (<i>Mirrored</i>)</b>		46.88%	46.21%
<b>Addressable Storage Capacity</b>		35.28%	34.78%
<b>Required Storage (<i>including spares</i>)</b>		6.45%	6.36%
<b>Configured Storage Capacity</b>			98.56%
<b>Global Storage Overhead</b>			1.44%
<b>Unused Storage:</b>			
<b>Addressable</b>	6.16%		
<b>Configured</b>		22.98%	
<b>Physical</b>			0.00%

The Physical Storage Capacity consisted of 299,008.000 GB distributed over 2,048 disk drives each with a formatted capacity of 143.900 GB. There was 0.000 GB (0.00%) of Unused Storage within the Physical Storage Capacity. Global Storage Overhead consisted of 4,300.800 GB (1.44%) of Physical Storage Capacity. There was 67,731.634 GB (22.98%) of Unused Storage within the Configured Storage Capacity. The Total ASU Capacity utilized 93.84% of the Addressable Storage Capacity resulting in 6,403.796 GB (6.16%) of Unused Storage within the Addressable Storage Capacity. The Data Protection (*mirroring*) capacity was 138,160.508 GB of which 104,294.691 GB was utilized. The total Unused Storage was 74,135.430 GB.

### SPC-1 Storage Capacities and Relationships Illustration

The various storage capacities configured in the benchmark result are illustrated below (not to scale).

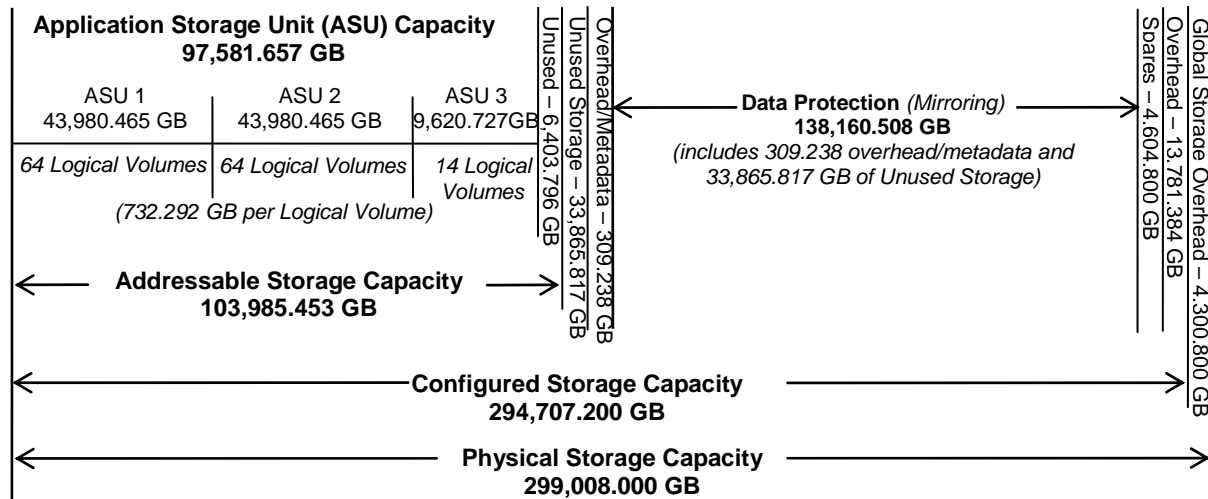

### Logical Volume Capacity and ASU Mapping

Clause 9.4.3.6.3

A table illustrating the capacity of each ASU and the mapping of Logical Volumes to ASUs shall be provided in the FDR. ... Logical Volumes shall be sequenced in the table from top to bottom per its position in the contiguous address space of each ASU. The capacity of each Logical Volume shall be stated. ... In conjunction with this table, the Test Sponsor shall provide a complete description of the type of data protection (see Clause 2.4.5) used on each Logical Volume.

Logical Volume Capacity and Mapping		
ASU-1 (43,980.683 GB)	ASU-2 (43,980.683 GB)	ASU-3 (9,620.727 GB)
64 Logical Volume 732.292 GB per Logical Volume (687.195 GB used per Logical Volume)	64 Logical Volume 732.292 GB per Logical Volume (687.195 GB used per Logical Volume)	14 Logical Volume 732.292 GB per Logical Volume (687.195 GB used per Logical Volume)

The Data Protection Level used for all Logical Volumes was “Mirrored” as described on page 11. See “ASU Configuration” in the [IOPS Test Results File](#) for more detailed configuration information.

## Storage Capacity Utilization

### Clause 9.4.3.6.2

*The FDR will include a table illustrating the storage capacity utilization values defined for Application Utilization (Clause 2.8.1), Protected Application Utilization (Clause 2.8.2), and Unused Storage Ratio (Clause 2.8.3).*

### Clause 2.8.1

*Application Utilization is defined as Total ASU Capacity divided by Physical Storage Capacity.*

### Clause 2.8.2

*Protected Application Utilization is defined as (Total ASU Capacity plus total Data Protection Capacity minus unused Data Protection Capacity) divided by Physical Storage Capacity.*

### Clause 2.8.3

*Unused Storage Ratio is defined as Total Unused Capacity divided by Physical Storage Capacity and may not exceed 45%.*

SPC-1 Storage Capacity Utilization	
Application Utilization	32.64%
Protected Application Utilization	67.52%
Unused Storage Ratio	24.79%

## **SPC-1 BENCHMARK EXECUTION RESULTS**

This portion of the Full Disclosure Report documents the results of the various SPC-1 Tests, Test Phases, and Test Runs. “SPC-1 Test Execution Definitions” on page 58 contains definitions of terms specific to the SPC-1 Tests, Test Phases, and Test Runs.

### ***Clause 5.4.3***

*The Tests must be executed in the following sequence: Primary Metrics, Repeatability, and Data Persistence. That required sequence must be uninterrupted from the start of Primary Metrics to the completion of Persistence Test Run 1. Uninterrupted means the Benchmark Configuration shall not be power cycled, restarted, disturbed, altered, or adjusted during the above measurement sequence. If the required sequence is interrupted other than for the Host System/TSC power cycle between the two Persistence Test Runs, the measurement is invalid.*

## **SPC-1 Tests, Test Phases, and Test Runs**

The SPC-1 benchmark consists of the following Tests, Test Phases, and Test Runs:

- **Primary Metrics Test**
  - Sustainability Test Phase and Test Run
  - IOPS Test Phase and Test Run
  - Response Time Ramp Test Phase
    - 95% of IOPS Test Run
    - 90% of IOPS Test Run
    - 80% of IOPS Test Run
    - 50% of IOPS Test Run
    - 10% of IOPS Test Run (LRT)
- **Repeatability Test**
  - Repeatability Test Phase 1
    - 10% of IOPS Test Run (LRT)
    - IOPS Test Run
  - Repeatability Test Phase 2
    - 10% of IOPS Test Run (LRT)
    - IOPS Test Run
- **Data Persistence Test**
  - Data Persistence Test Run 1
  - Data Persistence Test Run 2

Each Test is an atomic unit that must be executed from start to finish before any other Test, Test Phase, or Test Run may be executed.

The results from each Test, Test Phase, and Test Run are listed below along with a more detailed explanation of each component.

## Primary Metrics Test – Sustainability Test Phase

### Clause 5.4.4.1.1

*The Sustainability Test Phase has exactly one Test Run and shall demonstrate the maximum sustainable I/O Request Throughput within at least a continuous three (3) hour Measurement Interval. This Test Phase also serves to insure that the TSC has reached Steady State prior to reporting the final maximum I/O Request Throughput result (SPC-1 IOPS™).*

### Clause 5.4.4.1.2

*The computed I/O Request Throughput of the Sustainability Test must be within 5% of the reported SPC-1 IOPS™ result.*

### Clause 5.4.4.1.4

*The Average Response Time, as defined in Clause 5.1.1, will be computed and reported for the Sustainability Test Run and cannot exceed 30 milliseconds. If the Average Response time exceeds that 30-milliseconds constraint, the measurement is invalid.*

### Clause 9.4.3.7.1

*For the Sustainability Test Phase the FDR shall contain:*

- 1. A Data Rate Distribution graph and data table.*
- 2. I/O Request Throughput Distribution graph and data table.*
- 3. A Response Time Frequency Distribution graph and table.*
- 4. An Average Response Time Distribution graph and table.*
- 5. The human readable Test Run Results File produced by the Workload Generator (may be included in an appendix).*
- 6. A listing or screen image of all input parameters supplied to the Workload Generator (may be included in an appendix).*
- 7. The Measured Intensity Multiplier for each I/O stream.*
- 8. The variability of the Measured Intensity Multiplier, as defined in Clause 5.3.13.3.*

## SPC-1 Workload Generator Input Parameters

The SPC-1 Workload Generator input parameters for the Sustainability, IOPS, Response Time Ramp, Repeatability, and Persistence Test Runs are documented in “Appendix E: SPC-1 Workload Generator Input Parameters” on Page 109.

## Sustainability Test Results File

A link to the test results file generated from the Sustainability Test Run is listed below.

[Sustainability Test Results File](#)





### Sustainability – Data Rate Distribution Graph

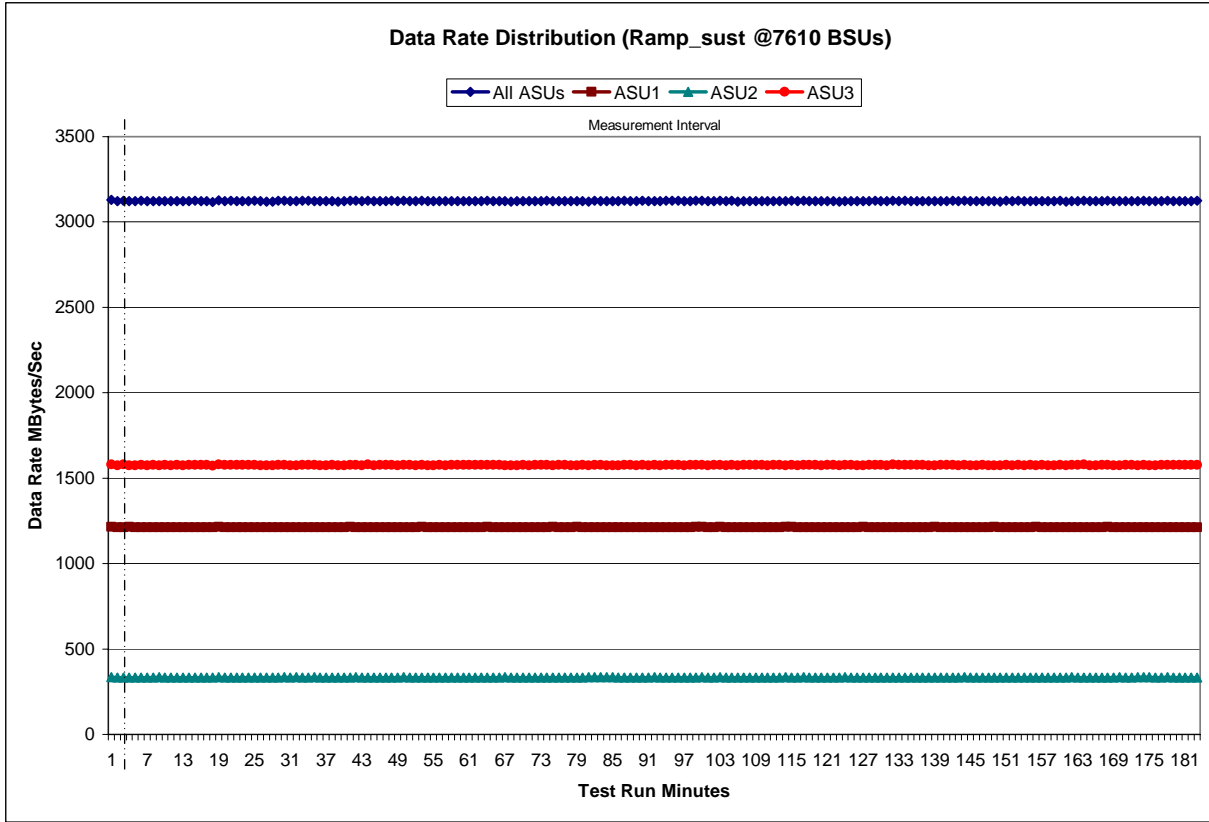



### Sustainability – I/O Request Throughput Distribution Graph

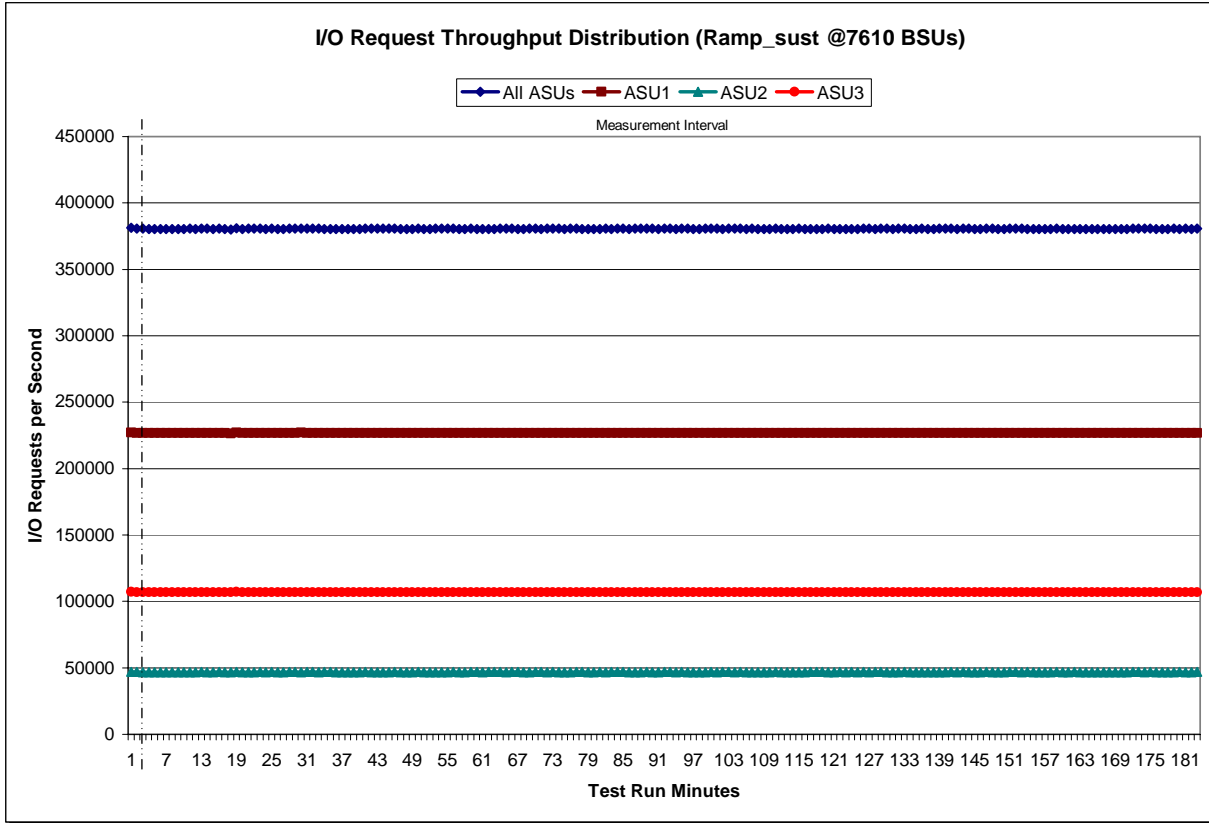



### Sustainability – Average Response Time (ms) Distribution Graph

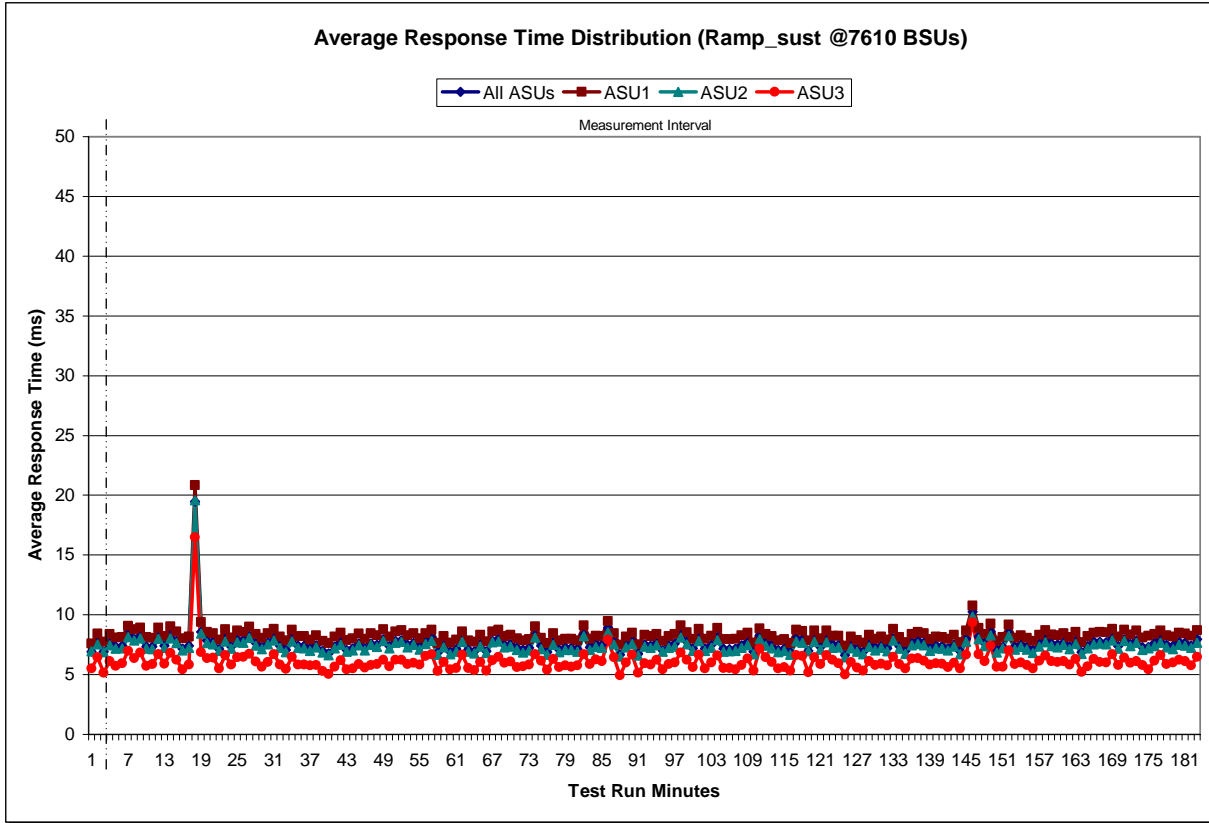

**Sustainability – Response Time Frequency Distribution Data**

Response Time (ms)	0-0.25	>0.25-0.5	>0.5-0.75	>0.75-1.0	>1.0-1.25	>1.25-1.5	>1.5-1.75	>1.75-2.0
Read	5,890,540	84,260,355	137,039,380	101,749,640	66,137,576	41,924,194	27,471,515	19,131,858
Write	48,790	124,648,213	360,360,916	388,536,791	343,594,195	262,308,871	182,498,326	120,816,767
All ASUs	5,939,330	208,908,568	497,400,296	490,286,431	409,731,771	304,233,065	209,969,841	139,948,625
ASU1	5,630,308	135,497,830	277,324,005	251,936,869	198,113,944	140,122,245	93,002,365	60,468,708
ASU2	296,514	30,288,062	72,698,088	66,947,462	52,188,346	36,581,029	24,198,110	15,706,259
ASU3	12,508	43,122,676	147,378,203	171,402,100	159,429,481	127,529,791	92,769,366	63,773,658

  

Response Time (ms)	>2.0-2.5	>2.5-3.0	>3.0-3.5	>3.5-4.0	>4.0-4.5	>4.5-5.0	>5.0-6.0	>6.0-7.0
Read	27,538,389	24,350,939	25,597,427	29,022,760	35,770,862	43,570,614	107,959,731	118,951,578
Write	136,403,551	72,132,005	45,722,072	33,432,954	26,899,923	22,755,218	34,795,507	24,094,366
All ASUs	163,941,940	96,482,944	71,319,499	62,455,714	62,670,785	66,325,832	142,755,238	143,045,944
ASU1	71,995,763	47,521,327	40,410,985	39,876,600	44,295,055	50,160,444	114,120,415	117,662,014
ASU2	18,267,719	10,782,134	7,670,913	6,140,528	5,491,790	5,489,466	12,413,228	13,964,617
ASU3	73,678,458	38,179,483	23,237,601	16,438,586	12,883,940	10,675,922	16,221,595	11,419,313

Response Time (ms)	>7.0-8.0	>8.0-9.0	>9.0-10.0	>10.0-15.0	>15.0-20.0	>20.0-25.0	>25.0-30.0	>30.0
Read	112,333,444	92,676,503	70,279,391	185,700,086	78,413,950	44,294,369	29,321,423	111,335,467
Write	18,054,523	14,580,164	12,161,893	42,805,512	31,866,741	29,081,792	28,636,156	132,444,970
All ASUs	130,387,967	107,256,667	82,441,284	228,505,598	110,280,691	73,376,161	57,957,579	243,780,437
ASU1	107,174,778	86,384,433	65,708,795	180,430,329	82,240,150	51,079,082	37,803,645	150,182,004
ASU2	14,460,334	13,751,048	10,812,023	27,913,749	13,458,179	9,067,196	7,132,102	29,756,163
ASU3	8,752,855	7,121,186	5,920,466	20,161,520	14,582,362	13,229,883	13,021,832	63,842,270

**Sustainability – Response Time Frequency Distribution Graph**

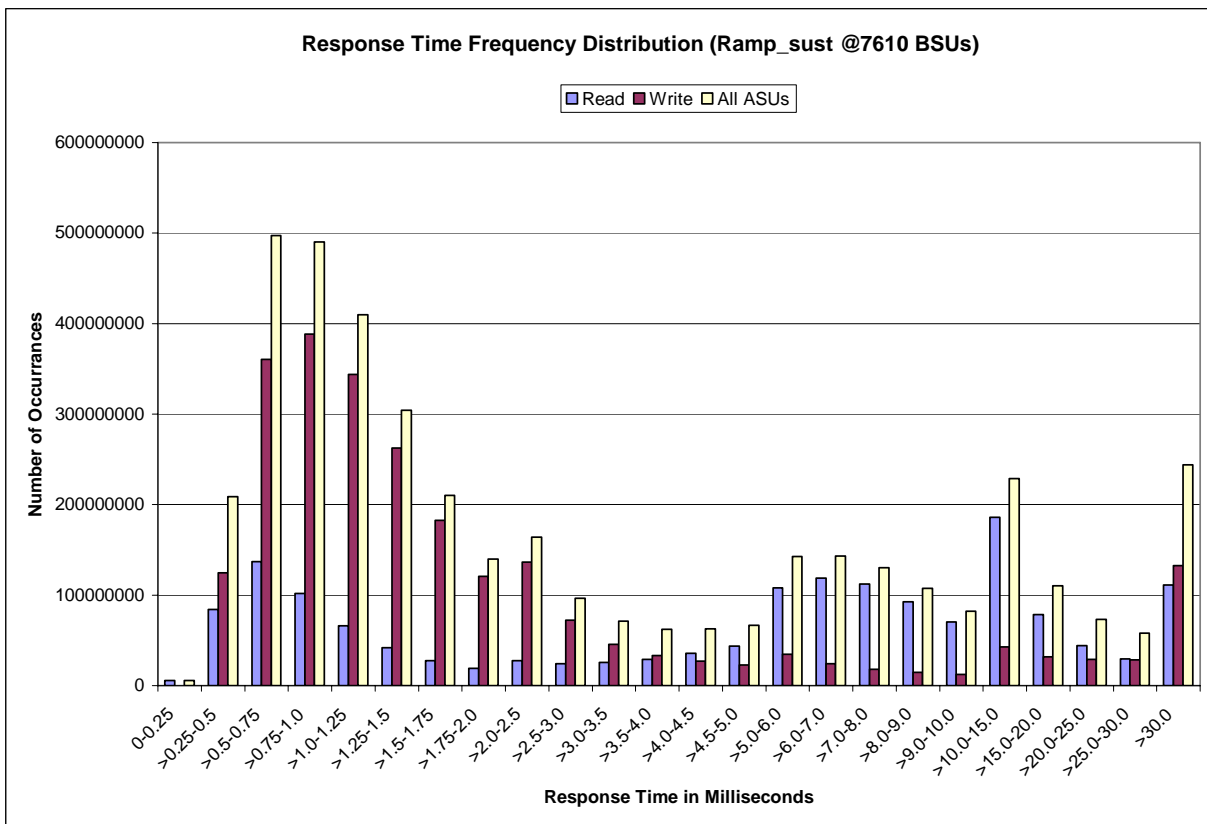

**Sustainability – Measured Intensity Multiplier and Coefficient of Variation**

Clause 3.4.3

**IM – Intensity Multiplier:** *The ratio of I/Os for each I/O stream relative to the total I/Os for all I/O streams (ASU1-1 – ASU3-1) as required by the benchmark specification.*

Clauses 5.1.10 and 5.3.13.2

**MIM – Measured Intensity Multiplier:** *The Measured Intensity Multiplier represents the ratio of measured I/Os for each I/O stream relative to the total I/Os measured for all I/O streams (ASU1-1 – ASU3-1). This value may differ from the corresponding Expected Intensity Multiplier by no more than 5%.*

Clause 5.3.13.3

**COV – Coefficient of Variation:** *This measure of variation for the Measured Intensity Multiplier cannot exceed 0.2.*

	ASU1-1	ASU1-2	ASU1-3	ASU1-4	ASU2-1	ASU2-2	ASU2-3	ASU3-1
IM	0.0350	0.2810	0.0700	0.2100	0.0180	0.0700	0.0350	0.2810
MIM	0.0350	0.2810	0.0700	0.2100	0.0180	0.0700	0.0350	0.2810
COV	0.001	0.000	0.001	0.000	0.002	0.001	0.001	0.000

## Primary Metrics Test – IOPS Test Phase

### Clause 5.4.4.2

*The IOPS Test Phase consists of one Test Run at the 100% load point with a Measurement Interval of ten (10) minutes. The IOPS Test Phase immediately follows the Sustainability Test Phase without any interruption or manual intervention.*

*The IOPS Test Run generates the SPC-1 IOPS™ primary metric, which is computed as the I/O Request Throughput for the Measurement Interval of the IOPS Test Run.*

*The Average Response Time is computed for the IOPS Test Run and cannot exceed 30 milliseconds. If the Average Response Time exceeds the 30 millisecond constraint, the measurement is invalid.*

### Clause 9.4.3.7.2

*For the IOPS Test Phase the FDR shall contain:*

- 1. I/O Request Throughput Distribution (data and graph).*
- 2. A Response Time Frequency Distribution.*
- 3. An Average Response Time Distribution.*
- 4. The human readable Test Run Results File produced by the Workload Generator.*
- 5. A listing or screen image of all input parameters supplied to the Workload Generator.*
- 6. The total number of I/O Requests completed in the Measurement Interval as well as the number of I/O Requests with a Response Time less than or equal to 30 milliseconds and the number of I/O Requests with a Response Time greater than 30 milliseconds.*

## SPC-1 Workload Generator Input Parameters

The SPC-1 Workload Generator input parameters for the Sustainability, IOPS, Response Time Ramp, Repeatability, and Persistence Test Runs are documented in “Appendix E: SPC-1 Workload Generator Input Parameters” on Page 109.

## IOPS Test Results File

A link to the test results file generated from the IOPS Test Run is listed below.

[IOPS Test Results File](#)



**IOPS Test Run – I/O Request Throughput Distribution Data**

7610 BSUs	Start	Stop	Interval	Duration
<i>Start-Up/Ramp-Up</i>	15:45:31	15:48:31	0-2	0:03:00
<i>Measurement Interval</i>	15:48:31	15:58:35	3-12	0:10:04
60 second intervals	All ASUs	ASU1	ASU2	ASU3
0	381,158.60	227,152.53	46,868.75	107,137.32
1	380,500.92	226,759.87	46,829.05	106,912.00
2	380,548.38	226,832.63	46,804.75	106,911.00
3	380,456.50	226,760.92	46,811.88	106,883.70
4	380,517.23	226,759.75	46,801.78	106,955.70
5	380,522.52	226,762.08	46,840.57	106,919.87
6	380,471.00	226,723.52	46,809.53	106,937.95
7	380,541.08	226,825.33	46,825.87	106,889.88
8	380,552.92	226,825.68	46,805.10	106,922.13
9	380,479.17	226,790.73	46,798.00	106,890.43
10	380,451.50	226,713.88	46,827.28	106,910.33
11	380,451.43	226,798.78	46,752.47	106,900.18
12	380,449.62	226,833.63	46,755.17	106,860.82
<i>Average</i>	<i>380,489.30</i>	<i>226,779.43</i>	<i>46,802.77</i>	<i>106,907.10</i>

**IOPS Test Run – I/O Request Throughput Distribution Graph**

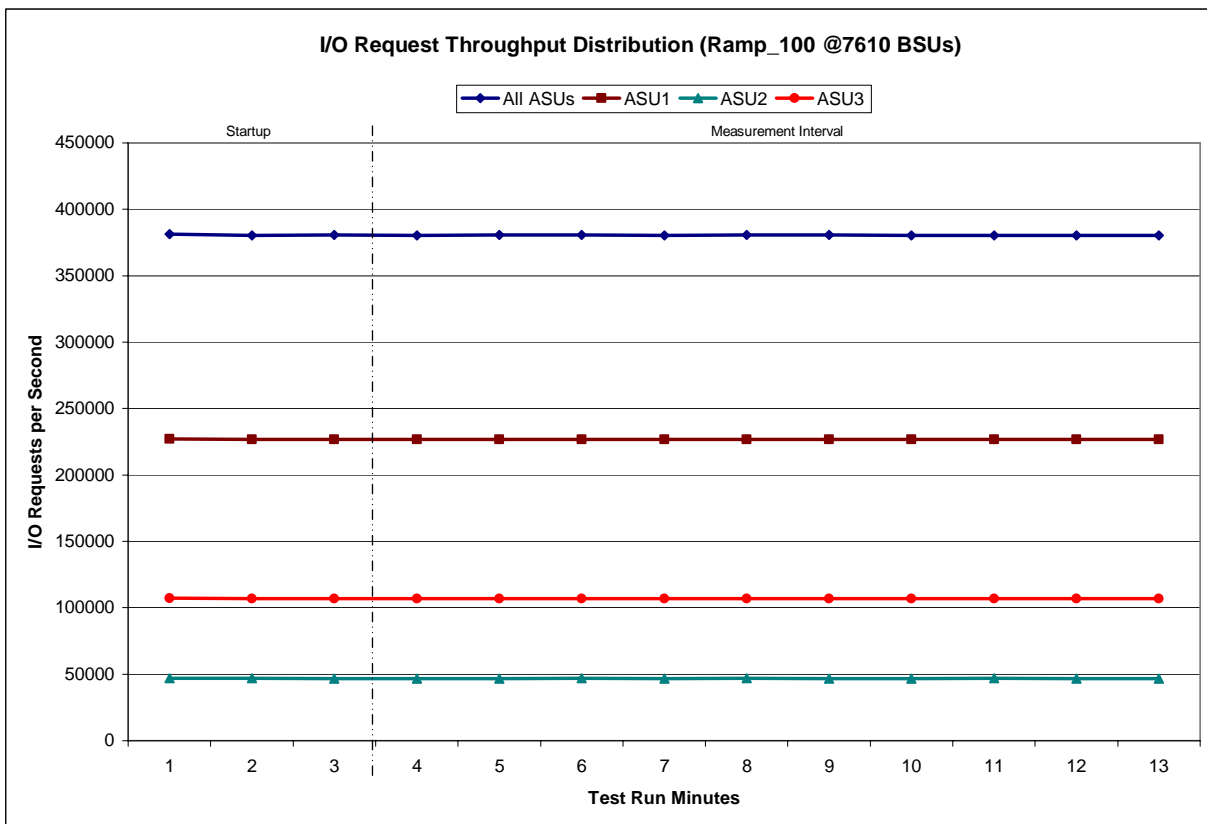

**IOPS Test Run – Average Response Time (ms) Distribution Data**

7610 BSUs	Start	Stop	Interval	Duration
Start-Up/Ramp-Up	15:45:31	15:48:31	0-2	0:03:00
Measurement Interval	15:48:31	15:58:35	3-12	0:10:04
60 second intervals	All ASUs	ASU1	ASU2	ASU3
0	6.40	7.16	6.36	4.82
1	7.95	8.69	7.74	6.48
2	8.41	9.17	8.26	6.85
3	8.22	8.95	8.06	6.76
4	7.27	8.03	7.07	5.74
5	7.17	7.97	7.01	5.52
6	7.47	8.23	7.28	5.94
7	7.33	8.09	7.17	5.80
8	8.58	9.28	8.33	7.19
9	7.70	8.43	7.50	6.24
10	7.49	8.17	7.26	6.14
11	7.97	8.69	7.77	6.53
12	7.19	7.90	7.01	5.76
<b>Average</b>	<b>7.64</b>	<b>8.37</b>	<b>7.45</b>	<b>6.16</b>

**IOPS Test Run – Average Response Time (ms) Distribution Graph**

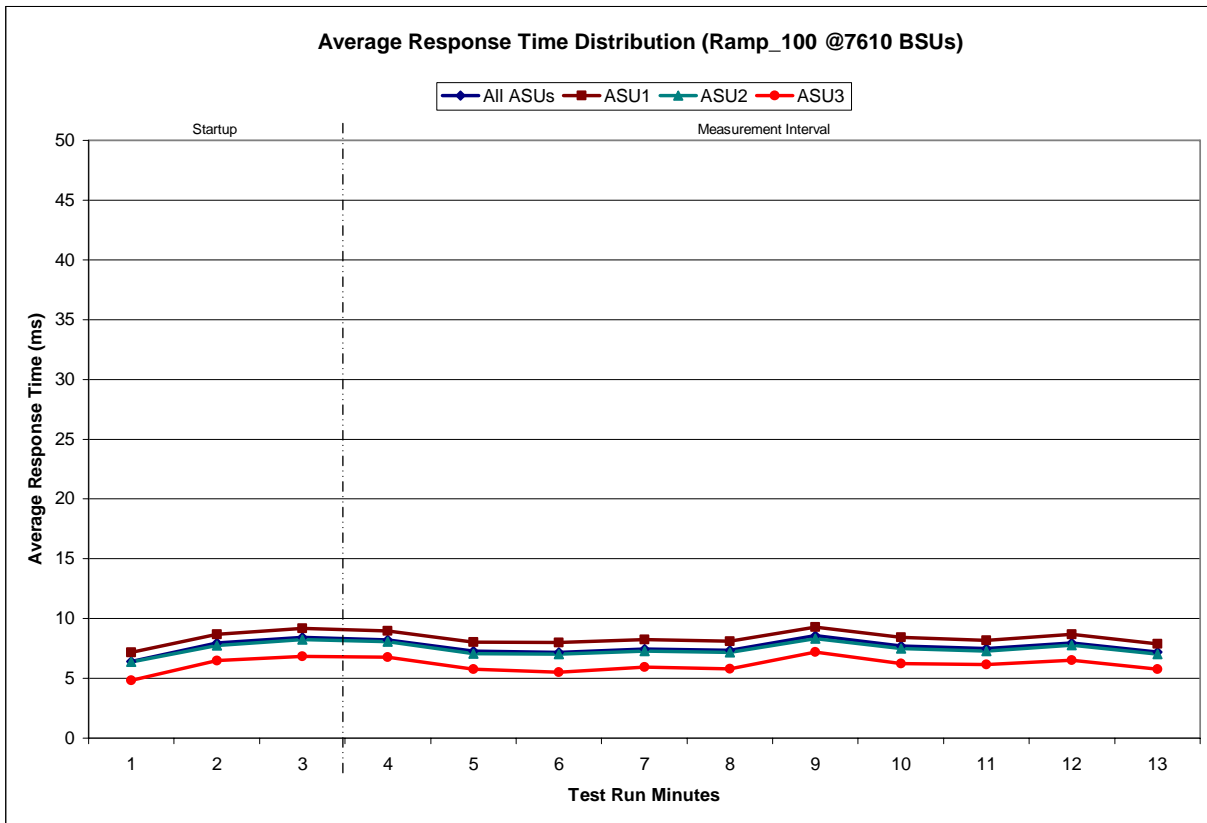

**IOPS Test Run – Response Time Frequency Distribution Data**

Response Time (ms)	0-0.25	>0.25-0.5	>0.5-0.75	>0.75-1.0	>1.0-1.25	>1.25-1.5	>1.5-1.75	>1.75-2.0
Read	355,453	4,989,097	7,868,709	5,822,028	3,783,315	2,357,325	1,509,238	1,032,129
Write	3,098	7,474,058	20,079,449	21,187,328	18,744,035	14,594,236	10,300,853	6,851,753
All ASUs	358,551	12,463,155	27,948,158	27,009,356	22,527,350	16,951,561	11,810,091	7,883,882
ASU1	340,895	8,068,082	15,617,778	13,924,151	10,952,889	7,855,119	5,256,335	3,411,858
ASU2	16,883	1,787,798	4,074,927	3,696,118	2,881,413	2,043,610	1,358,069	877,870
ASU3	773	2,607,275	8,255,453	9,389,087	8,693,048	7,052,832	5,195,687	3,594,154
Response Time (ms)	>2.0-2.5	>2.5-3.0	>3.0-3.5	>3.5-4.0	>4.0-4.5	>4.5-5.0	>5.0-6.0	>6.0-7.0
Read	1,488,378	1,333,528	1,408,676	1,612,298	1,993,718	2,435,201	6,015,344	6,575,205
Write	7,687,121	3,986,476	2,476,307	1,789,045	1,429,347	1,201,788	1,830,092	1,281,396
All ASUs	9,175,499	5,320,004	3,884,983	3,401,343	3,423,065	3,636,989	7,845,436	7,856,601
ASU1	4,010,531	2,608,037	2,207,741	2,190,446	2,444,330	2,776,740	6,310,581	6,477,133
ASU2	1,004,188	581,071	408,990	326,550	291,942	294,870	678,824	771,890
ASU3	4,160,780	2,130,896	1,268,252	884,347	686,793	565,379	856,031	607,578
Response Time (ms)	>7.0-8.0	>8.0-9.0	>9.0-10.0	>10.0-15.0	>15.0-20.0	>20.0-25.0	>25.0-30.0	>30.0
Read	6,176,909	5,045,326	3,785,719	9,955,154	4,221,782	2,420,097	1,615,104	6,247,345
Write	982,702	803,017	669,456	2,381,329	1,793,390	1,624,498	1,566,932	7,506,667
All ASUs	7,159,611	5,848,343	4,455,175	12,336,483	6,015,172	4,044,595	3,182,036	13,754,012
ASU1	5,884,655	4,698,301	3,539,350	9,698,299	4,457,291	2,802,586	2,074,932	8,458,147
ASU2	802,833	760,142	591,166	1,518,484	738,420	501,028	392,483	1,681,831
ASU3	472,123	389,900	324,659	1,119,700	819,461	740,981	714,621	3,614,034

**IOPS Test Run –Response Time Frequency Distribution Graph**

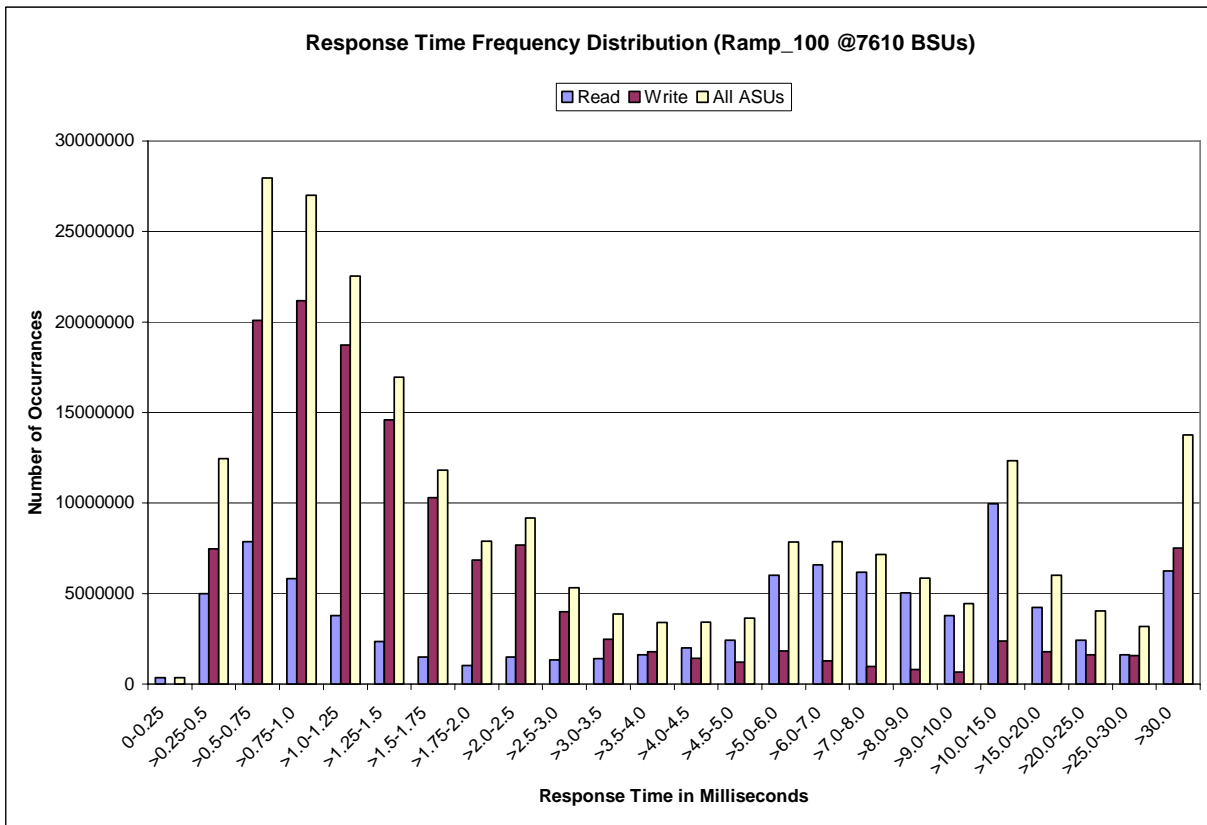

**IOPS Test Run – I/O Request Information**

I/O Requests Completed in the Measurement Interval	I/O Requests Completed with Response Time = or < 30 ms	I/O Requests Completed with Response Time > 30 ms
228,291,451	214,537,439	13,754,012

**IOPS Test Run – Measured Intensity Multiplier and Coefficient of Variation**

Clause 3.4.3

**IM – Intensity Multiplier:** The ratio of I/Os for each I/O stream relative to the total I/Os for all I/O streams (ASU1-1 – ASU3-1) as required by the benchmark specification.

Clauses 5.1.10 and 5.3.13.2

**MIM – Measured Intensity Multiplier:** The Measured Intensity Multiplier represents the ratio of measured I/Os for each I/O stream relative to the total I/Os measured for all I/O streams (ASU1-1 – ASU3-1). This value may differ from the corresponding Expected Intensity Multiplier by no more than 5%.

Clause 5.3.13.3

**COV – Coefficient of Variation:** This measure of variation for the Measured Intensity Multiplier cannot exceed 0.2.

	ASU1-1	ASU1-2	ASU1-3	ASU1-4	ASU2-1	ASU2-2	ASU2-3	ASU3-1
IM	0.0350	0.2810	0.0700	0.2100	0.0180	0.0700	0.0350	0.2810
MIM	0.0350	0.2810	0.0700	0.2100	0.0180	0.0700	0.0350	0.2810
COV	0.001	0.000	0.001	0.000	0.001	0.001	0.001	0.000

## Primary Metrics Test – Response Time Ramp Test Phase

### Clause 5.4.4.3

*The Response Time Ramp Test Phase consists of five Test Runs, one each at 95%, 90%, 80%, 50%, and 10% of the load point (100%) used to generate the SPC-1 IOPS™ primary metric. Each of the five Test Runs has a Measurement Interval of ten (10) minutes. The Response Time Ramp Test Phase immediately follows the IOPS Test Phase without any interruption or manual intervention.*

*The five Response Time Ramp Test Runs, in conjunction with the IOPS Test Run (100%), demonstrate the relationship between Average Response Time and I/O Request Throughput for the Tested Storage Configuration (TSC) as illustrated in the response time/throughput curve on page 13.*

*In addition, the Average Response Time measured during the 10% Test Run is the value for the SPC-1 LRT™ metric. That value represents the Average Response Time of a lightly loaded TSC.*

### Clause 9.4.3.7.3

*The following content shall appear in the FDR for the Response Time Ramp Phase:*

- 1. A Response Time Ramp Distribution.*
- 2. The human readable Test Run Results File produced by the Workload Generator for each Test Run within the Response Time Ramp Test Phase.*
- 3. For the 10% Load Level Test Run (SPC-1 LRT™ metric) an Average Response Time Distribution.*
- 4. A listing or screen image of all input parameters supplied to the Workload Generator.*

## SPC-1 Workload Generator Input Parameters

The SPC-1 Workload Generator input parameters for the Sustainability, IOPS, Response Time Ramp, Repeatability, and Persistence Test Runs are documented in “Appendix E: SPC-1 Workload Generator Input Parameters” on Page 109.

## Response Time Ramp Test Results File

A link to each test result file generated from each Response Time Ramp Test Run list listed below.

[95% Load Level](#)

[90% Load Level](#)

[80% Load Level](#)

[50% Load Level](#)

[10% Load Level](#)



**Response Time Ramp Distribution (IOPS) Graph**

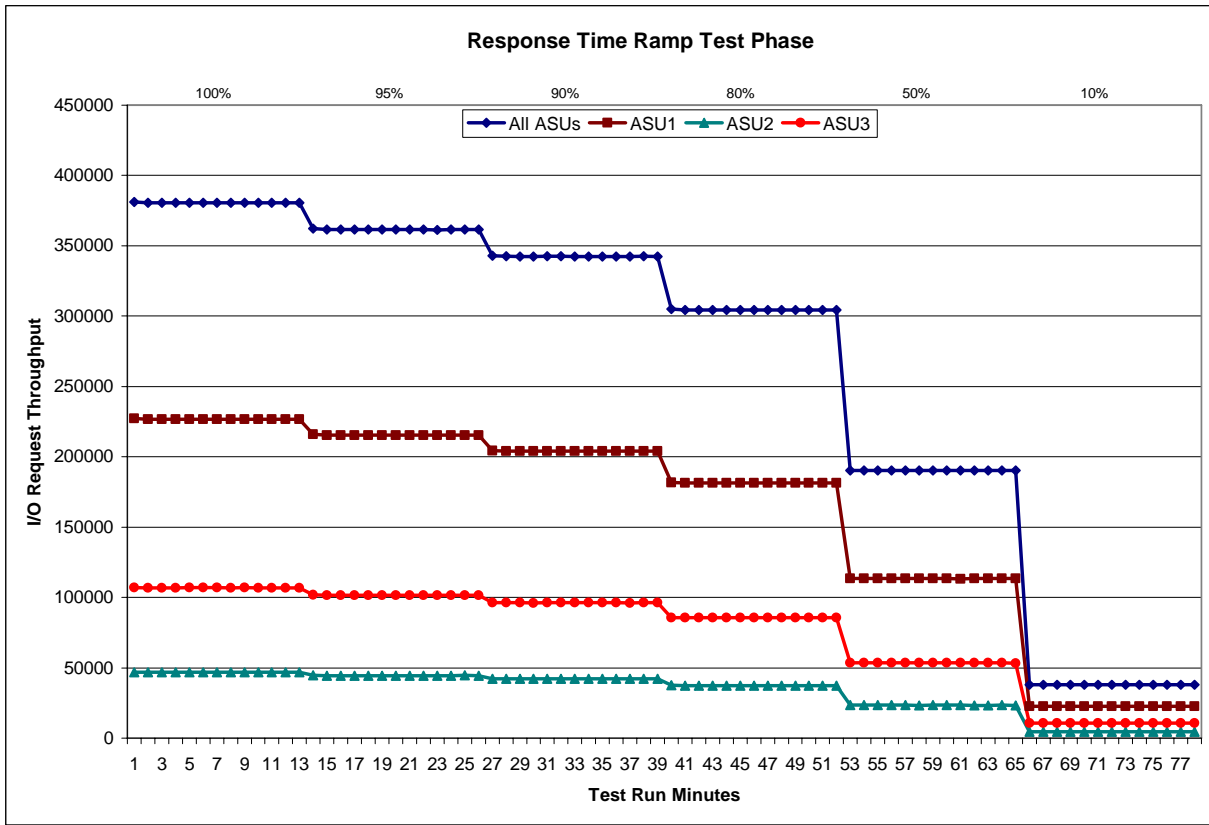

**SPC-1 LRT™ Average Response Time (ms) Distribution Data**

761 BSUs	Start	Stop	Interval	Duration
<i>Start-Up/Ramp-Up</i>	17:27:52	17:30:52	0-2	0:03:00
<i>Measurement Interval</i>	17:30:52	17:40:55	3-12	0:10:03
60 second intervals	All ASUs	ASU1	ASU2	ASU3
0	2.24	2.88	2.16	0.93
1	2.22	2.85	2.02	0.98
2	2.21	2.85	2.00	0.94
3	2.21	2.84	1.99	0.95
4	2.21	2.86	1.99	0.94
5	2.23	2.87	2.00	0.96
6	2.20	2.83	2.01	0.94
7	2.20	2.83	1.98	0.94
8	2.21	2.83	1.99	0.97
9	2.21	2.84	2.00	0.95
10	2.20	2.83	1.98	0.95
11	2.18	2.81	1.99	0.94
12	2.18	2.81	1.98	0.93
<i>Average</i>	<i>2.20</i>	<i>2.84</i>	<i>1.99</i>	<i>0.95</i>

**SPC-1 LRT™ Average Response Time (ms) Distribution Graph**

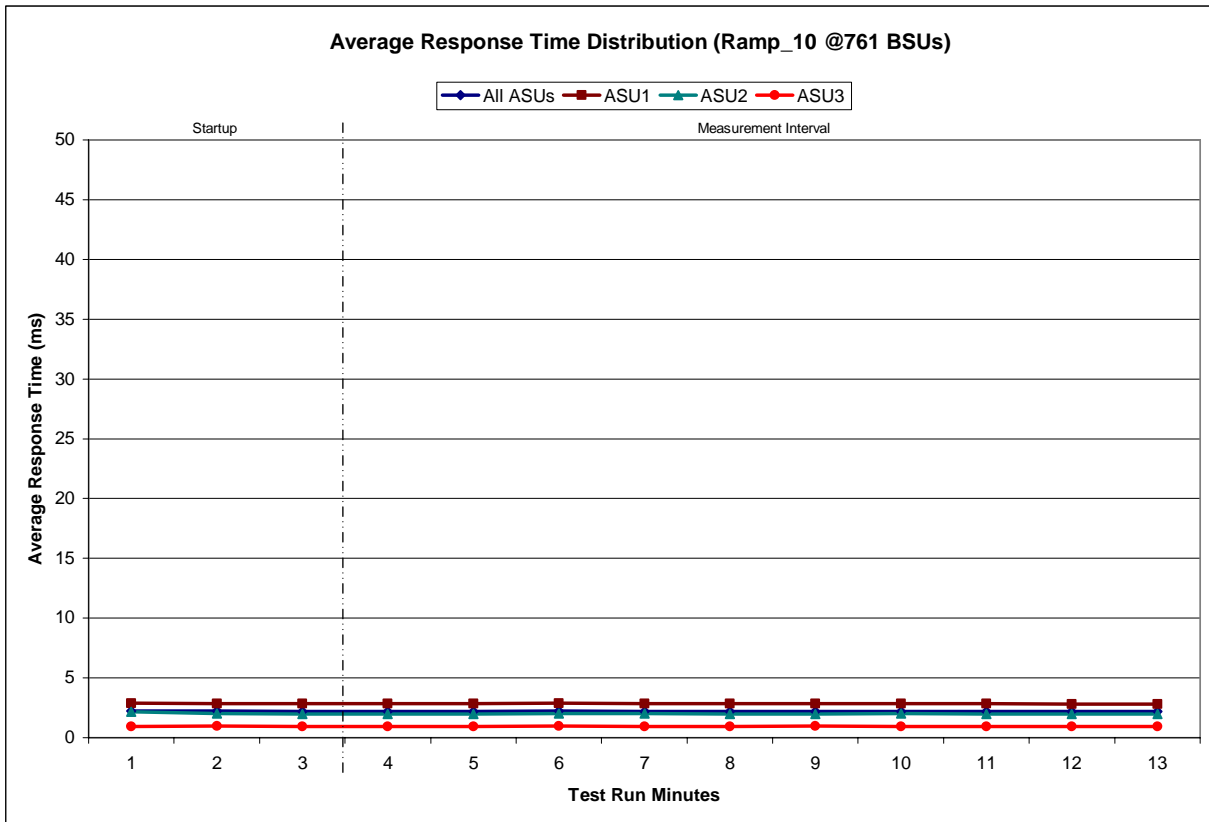



**SPC-1 LRT™ (10%) – Measured Intensity Multiplier and Coefficient of Variation**

Clause 3.4.3

**IM – Intensity Multiplier:** *The ratio of I/Os for each I/O stream relative to the total I/Os for all I/O streams (ASU1-1 – ASU3-1) as required by the benchmark specification.*

Clauses 5.1.10 and 5.3.13.2

**MIM – Measured Intensity Multiplier:** *The Measured Intensity Multiplier represents the ratio of measured I/Os for each I/O stream relative to the total I/Os measured for all I/O streams (ASU1-1 – ASU3-1). This value may differ from the corresponding Expected Intensity Multiplier by no more than 5%.*

Clause 5.3.13.3

**COV – Coefficient of Variation:** *This measure of variation for the Measured Intensity Multiplier cannot exceed 0.2.*

	ASU1-1	ASU1-2	ASU1-3	ASU1-4	ASU2-1	ASU2-2	ASU2-3	ASU3-1
IM	0.0350	0.2810	0.0700	0.2100	0.0180	0.0700	0.0350	0.2810
MIM	0.0350	0.2809	0.0699	0.2100	0.0180	0.0701	0.0350	0.2810
COV	0.004	0.001	0.003	0.001	0.005	0.003	0.004	0.001

## Repeatability Test

### Clause 5.4.5

*The Repeatability Test demonstrates the repeatability and reproducibility of the SPC-1 IOPS™ primary metric and SPC-1 LRT™ metric generated in earlier Test Runs.*

*There are two identical Repeatability Test Phases. Each Test Phase contains two Test Runs. Each of the Test Runs will have a Measurement Interval of no less than ten (10) minutes. The two Test Runs in each Test Phase will be executed without interruption or any type of manual intervention.*

*The first Test Run in each Test Phase is executed at the 10% load point. The Average Response Time from each of the Test Runs is compared to the SPC-1 LRT™ metric. Each Average Response Time value must be less than the SPC-1 LRT™ metric plus 5% or less than the SPC-1 LRT™ metric plus one (1) millisecond (ms).*

*The second Test Run in each Test Phase is executed at the 100% load point. The I/O Request Throughput from the Test Runs is compared to the SPC-1 IOPS™ primary metric. Each I/O Request Throughput value must be greater than the SPC-1 IOPS™ primary metric minus 5%. In addition, the Average Response Time for each Test Run cannot exceed 30 milliseconds.*

*If any of the above constraints are not met, the benchmark measurement is invalid.*

### Clause 9.4.3.7.4

*The following content shall appear in the FDR for each Test Run in the two Repeatability Test Phases:*

- 1. A table containing the results of the Repeatability Test.*
- 2. An I/O Request Throughput Distribution graph and table.*
- 3. An Average Response Time Distribution graph and table.*
- 4. The human readable Test Run Results File produced by the Workload Generator.*
- 5. A listing or screen image of all input parameters supplied to the Workload Generator.*

## SPC-1 Workload Generator Input Parameters

The SPC-1 Workload Generator input parameters for the Sustainability, IOPS, Response Time Ramp, Repeatability, and Persistence Test Runs are documented in “Appendix E: SPC-1 Workload Generator Input Parameters” on Page 109.

### Repeatability Test Results File

The values for the SPC-1 IOPS™, SPC-1 LRT™, and the Repeatability Test measurements are listed in the tables below.

	SPC-1 IOPS™
<b>Primary Metrics</b>	<b>380,489.30</b>
Repeatability Test Phase 1	380,493.36
Repeatability Test Phase 2	380,488.31

The SPC-1 IOPS™ values in the above table were generated using 100% of the specified Business Scaling Unit (BSU) load level. Each of the Repeatability Test Phase values for SPC-1 IOPS™ must be greater than 95% of the reported SPC-1 IOPS™ Primary Metric.

	SPC-1 LRT™
<b>Primary Metrics</b>	<b>2.20 ms</b>
Repeatability Test Phase 1	2.21 ms
Repeatability Test Phase 2	2.21 ms

The average response time values in the SPC-1 LRT™ column were generated using 10% of the specified Business Scaling Unit (BSU) load level. Each of the Repeatability Test Phase values for SPC-1 LRT™ must be less than 105% of the reported SPC-1 LRT™ Primary Metric or less than the reported SPC-1 LRT™ Primary Metric minus one (1) millisecond (ms)..

A link to the test result file generated from each Repeatability Test Run is listed below.

- [Repeatability Test Phase 1, Test Run 1 \(LRT\)](#)
- [Repeatability Test Phase 1, Test Run 2 \(IOPS\)](#)
- [Repeatability Test Phase 2, Test Run 1 \(LRT\)](#)
- [Repeatability Test Phase 2, Test Run 2 \(IOPS\)](#)

**Repeatability 1 LRT - I/O Request Throughput Distribution Data**

761 BSUs	Start	Stop	Interval	Duration
Start-Up/Ramp-Up	17:46:37	17:49:37	0-2	0:03:00
Measurement Interval	17:49:37	17:59:40	3-12	0:10:03
60 second intervals	All ASUs	ASU1	ASU2	ASU3
0	38,046.43	22,662.62	4,689.67	10,694.15
1	38,076.32	22,700.20	4,683.30	10,692.82
2	38,068.47	22,684.58	4,688.35	10,695.53
3	38,060.43	22,666.45	4,677.27	10,716.72
4	38,029.33	22,660.25	4,685.28	10,683.80
5	38,085.62	22,700.45	4,674.07	10,711.10
6	38,055.23	22,671.33	4,680.32	10,703.58
7	38,021.58	22,641.97	4,686.65	10,692.97
8	38,071.12	22,651.88	4,697.38	10,721.85
9	38,048.92	22,659.82	4,684.03	10,705.07
10	38,066.35	22,723.90	4,668.35	10,674.10
11	38,037.10	22,670.30	4,682.08	10,684.72
12	38,030.28	22,688.80	4,664.03	10,677.45
<b>Average</b>	<b>38,050.60</b>	<b>22,673.52</b>	<b>4,679.95</b>	<b>10,697.14</b>

**Repeatability 1 LRT - I/O Request Throughput Distribution Graph**

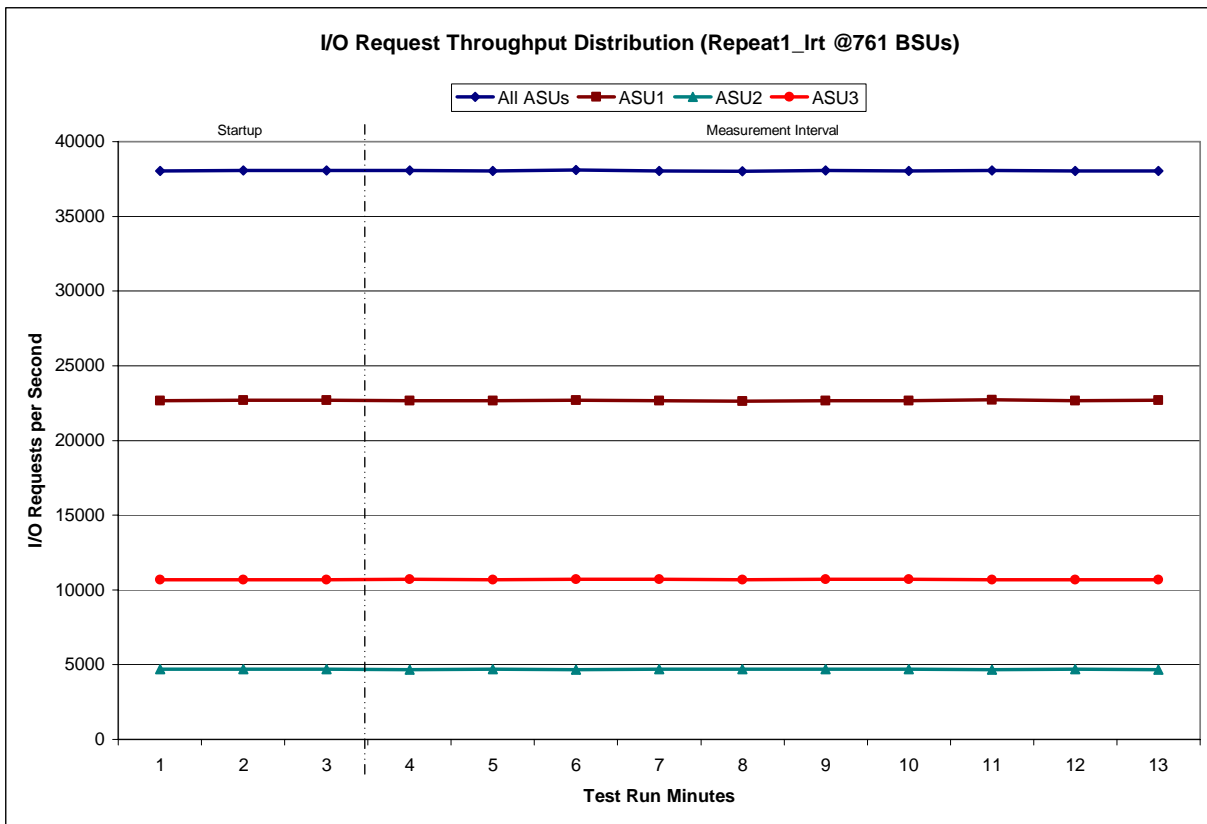

**Repeatability 1 LRT –Average Response Time (ms) Distribution Data**

761 BSUs	Start	Stop	Interval	Duration
<i>Start-Up/Ramp-Up</i>	17:46:37	17:49:37	0-2	0:03:00
<i>Measurement Interval</i>	17:49:37	17:59:40	3-12	0:10:03
60 second intervals	All ASUs	ASU1	ASU2	ASU3
0	2.28	2.91	2.17	0.96
1	2.23	2.87	2.00	0.96
2	2.21	2.85	1.99	0.95
3	2.20	2.84	1.99	0.96
4	2.20	2.83	1.99	0.95
5	2.22	2.86	2.00	0.97
6	2.22	2.87	2.01	0.95
7	2.22	2.86	2.00	0.97
8	2.20	2.83	1.99	0.94
9	2.28	2.91	2.05	1.05
10	2.20	2.82	1.98	0.96
11	2.18	2.81	1.99	0.93
12	2.20	2.83	1.97	0.95
<i>Average</i>	<i>2.21</i>	<i>2.85</i>	<i>2.00</i>	<i>0.96</i>

**Repeatability 1 LRT –Average Response Time (ms) Distribution Graph**

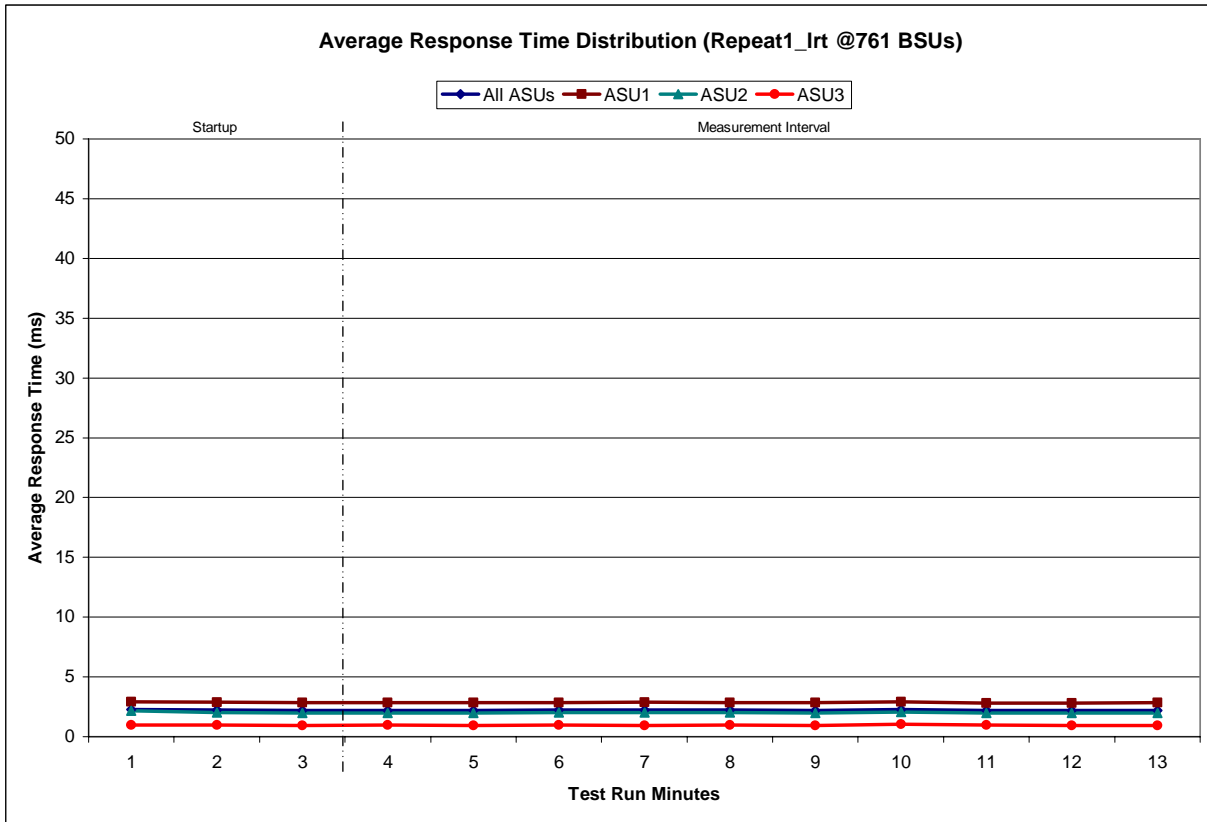

**Repeatability 1 IOPS - I/O Request Throughput Distribution Data**

7610 BSUs	Start	Stop	Interval	Duration
Start-Up/Ramp-Up	18:06:40	18:09:41	0-2	0:03:01
Measurement Interval	18:09:41	18:19:45	3-12	0:10:04
60 second intervals	All ASUs	ASU1	ASU2	ASU3
0	380,739.77	226,928.17	46,801.42	107,010.18
1	380,676.70	226,880.33	46,815.00	106,981.37
2	380,567.45	226,740.32	46,820.33	107,006.80
3	380,472.05	226,861.30	46,820.25	106,790.50
4	380,464.88	226,743.33	46,804.20	106,917.35
5	380,676.92	226,884.63	46,808.78	106,983.50
6	380,636.77	226,828.02	46,819.13	106,989.62
7	380,386.72	226,669.43	46,784.88	106,932.40
8	380,406.30	226,663.92	46,838.38	106,904.00
9	380,385.90	226,739.77	46,792.83	106,853.30
10	380,629.23	226,892.80	46,815.52	106,920.92
11	380,452.92	226,705.67	46,800.25	106,947.00
12	380,421.92	226,710.88	46,830.60	106,880.43
<b>Average</b>	<b>380,493.36</b>	<b>226,769.98</b>	<b>46,811.48</b>	<b>106,911.90</b>

**Repeatability 1 IOPS - I/O Request Throughput Distribution Graph**

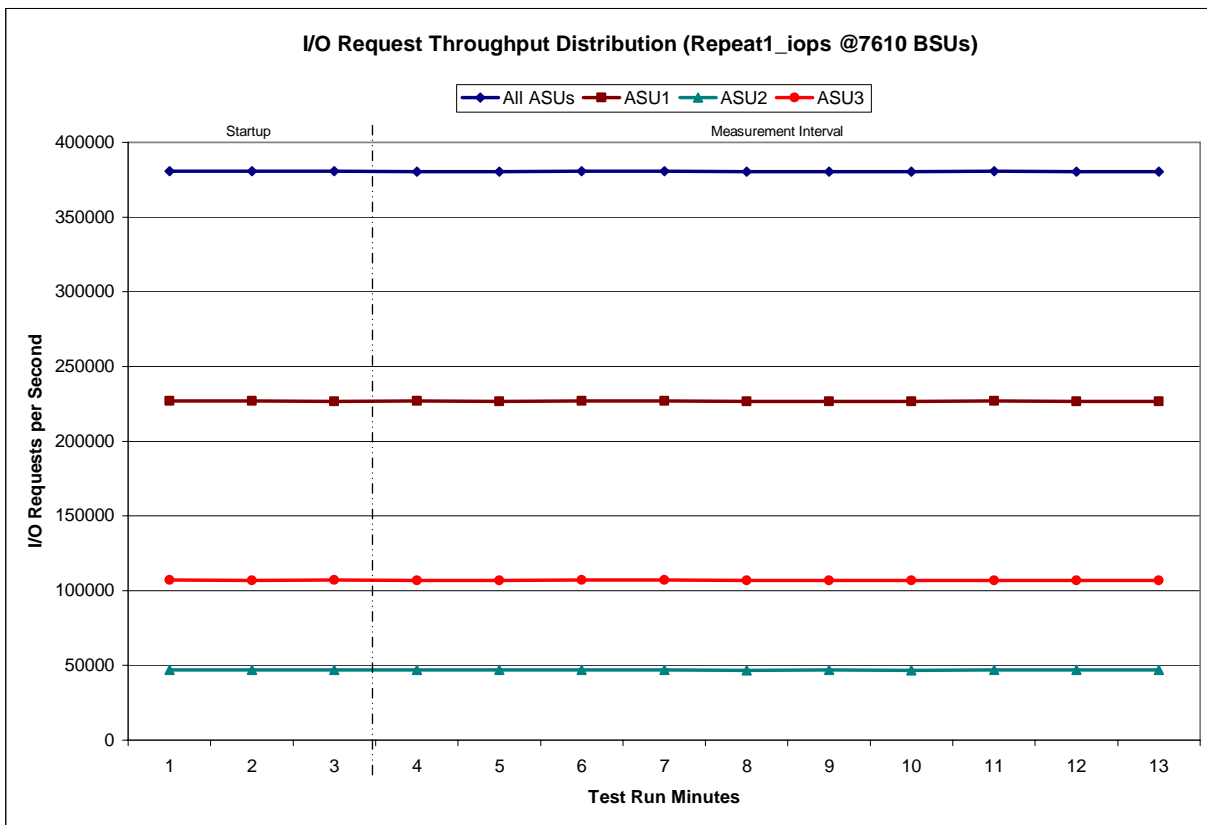

**Repeatability 1 IOPS –Average Response Time (ms) Distribution Data**

7610 BSUs	Start	Stop	Interval	Duration
<i>Start-Up/Ramp-Up</i>	18:06:40	18:09:41	0-2	0:03:01
<i>Measurement Interval</i>	18:09:41	18:19:45	3-12	0:10:04
60 second intervals	All ASUs	ASU1	ASU2	ASU3
0	7.57	8.07	7.50	6.55
1	7.98	8.69	7.79	6.55
2	8.87	9.71	8.68	7.17
3	7.89	8.64	7.65	6.42
4	7.88	8.69	7.74	6.23
5	7.76	8.57	7.61	6.11
6	6.93	7.71	6.74	5.37
7	7.92	8.70	7.73	6.34
8	7.15	7.97	6.99	5.50
9	7.25	8.08	7.13	5.54
10	7.59	8.36	7.40	6.04
11	6.99	7.88	6.89	5.15
12	7.78	8.58	7.62	6.16
<i>Average</i>	<i>7.52</i>	<i>8.32</i>	<i>7.35</i>	<i>5.89</i>

**Repeatability 1 IOPS –Average Response Time (ms) Distribution Graph**

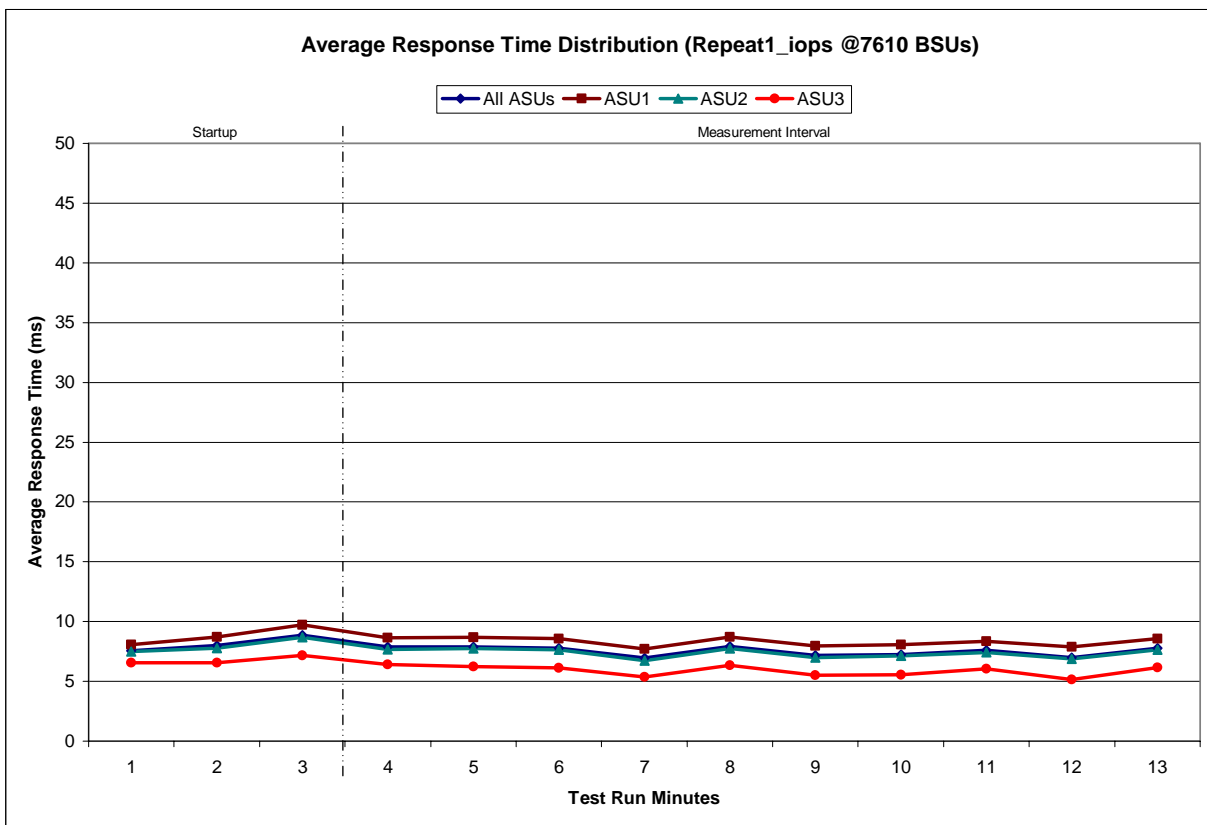

**Repeatability 2 LRT - I/O Request Throughput Distribution Data**

761 BSUs	Start	Stop	Interval	Duration
<i>Start-Up/Ramp-Up</i>	18:25:40	18:28:40	0-2	0:03:00
<i>Measurement Interval</i>	18:28:40	18:38:43	3-12	0:10:03
60 second intervals	All ASUs	ASU1	ASU2	ASU3
0	38,119.17	22,726.63	4,681.23	10,711.30
1	38,036.47	22,672.18	4,687.85	10,676.43
2	38,075.78	22,691.53	4,681.67	10,702.58
3	38,057.15	22,676.10	4,684.18	10,696.87
4	38,056.12	22,686.75	4,688.35	10,681.02
5	38,065.28	22,696.60	4,683.35	10,685.33
6	38,013.93	22,651.60	4,666.42	10,695.92
7	38,014.73	22,650.55	4,682.58	10,681.60
8	38,058.62	22,692.72	4,668.60	10,697.30
9	38,045.12	22,670.60	4,680.77	10,693.75
10	38,049.25	22,669.73	4,693.85	10,685.67
11	38,033.72	22,676.28	4,672.88	10,684.55
12	38,051.38	22,667.98	4,698.47	10,684.93
<b>Average</b>	<b>38,044.53</b>	<b>22,673.89</b>	<b>4,681.95</b>	<b>10,688.69</b>

**Repeatability 2 LRT - I/O Request Throughput Distribution Graph**

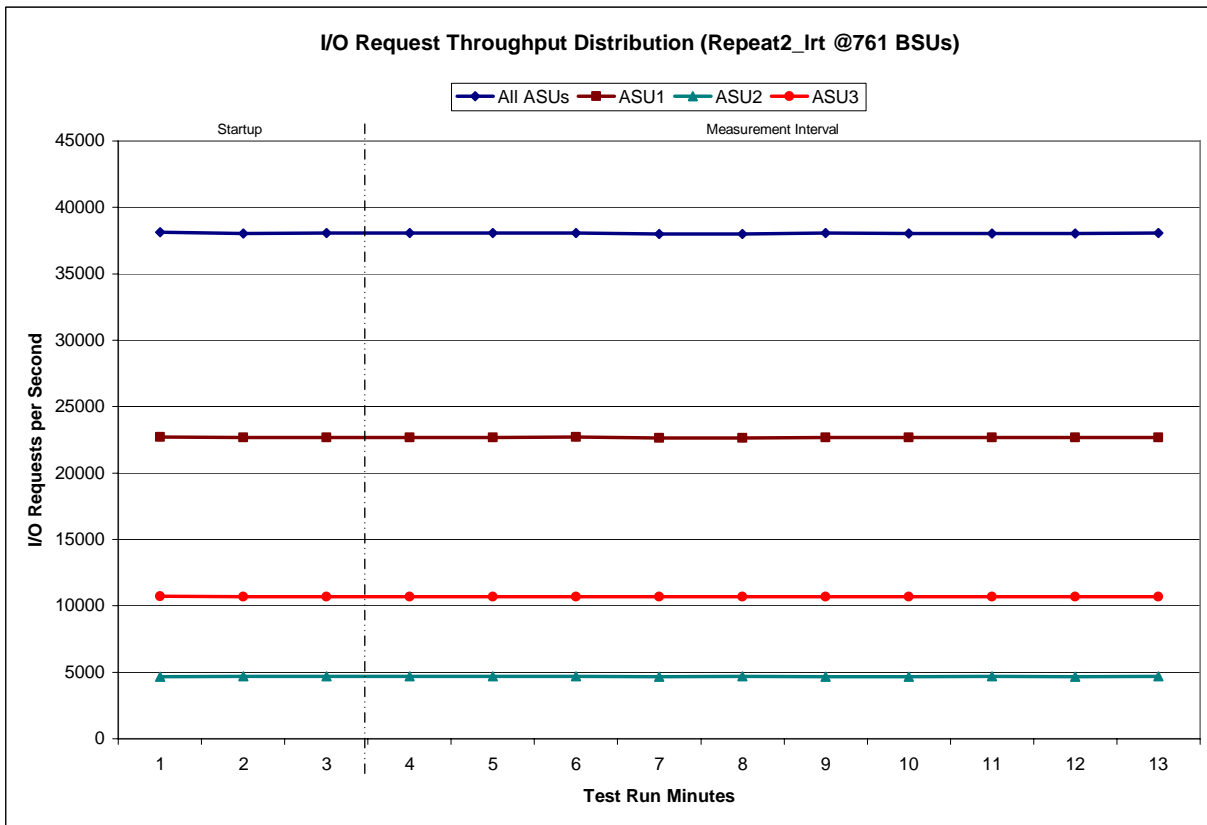



**Repeatability 2 LRT –Average Response Time (ms) Distribution Data**

761 BSUs	Start	Stop	Interval	Duration
<i>Start-Up/Ramp-Up</i>	18:25:40	18:28:40	0-2	0:03:00
<i>Measurement Interval</i>	18:28:40	18:38:43	3-12	0:10:03
60 second intervals	All ASUs	ASU1	ASU2	ASU3
0	2.24	2.89	2.13	0.92
1	2.21	2.85	1.98	0.94
2	2.20	2.85	1.97	0.94
3	2.22	2.86	2.00	0.97
4	2.22	2.86	1.99	0.94
5	2.20	2.84	1.99	0.94
6	2.23	2.86	2.02	0.98
7	2.21	2.85	1.97	0.95
8	2.20	2.84	1.99	0.95
9	2.19	2.83	1.97	0.93
10	2.19	2.82	1.96	0.94
11	2.21	2.84	2.00	0.95
12	2.20	2.84	1.97	0.94
<b>Average</b>	<b>2.21</b>	<b>2.84</b>	<b>1.99</b>	<b>0.95</b>

**Repeatability 2 LRT –Average Response Time (ms) Distribution Graph**

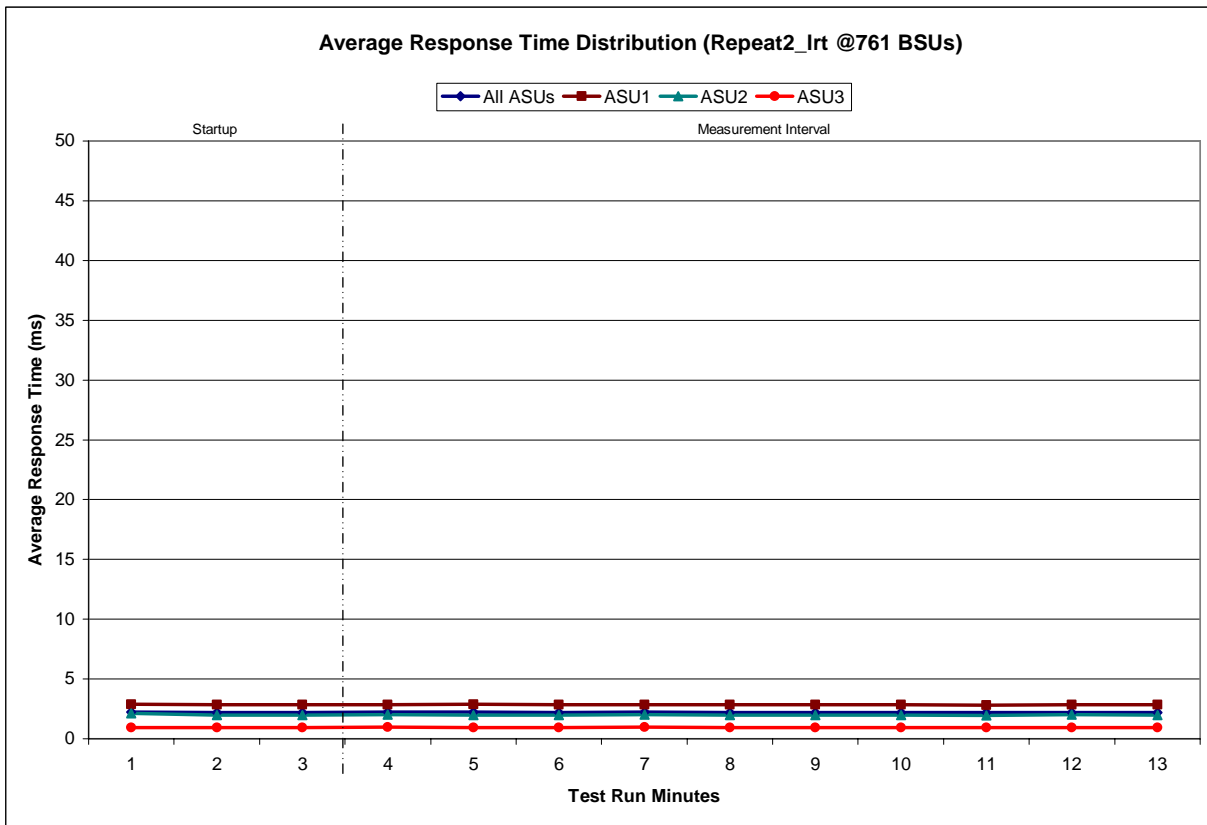

**Repeatability 2 IOPS - I/O Request Throughput Distribution Data**

7610 BSUs	Start	Stop	Interval	Duration
Start-Up/Ramp-Up	18:45:43	18:48:44	0-2	0:03:01
Measurement Interval	18:48:44	18:58:48	3-12	0:10:04
60 second intervals	All ASUs	ASU1	ASU2	ASU3
0	380,861.43	226,898.03	46,916.08	107,047.32
1	380,426.85	226,768.98	46,752.03	106,905.83
2	380,576.22	226,815.62	46,831.72	106,928.88
3	380,489.30	226,825.80	46,762.77	106,900.73
4	380,367.08	226,638.53	46,823.67	106,904.88
5	380,476.73	226,759.38	46,811.03	106,906.32
6	380,411.45	226,724.18	46,784.95	106,902.32
7	380,487.42	226,781.58	46,776.92	106,928.92
8	380,473.20	226,744.22	46,770.70	106,958.28
9	380,677.98	226,884.78	46,857.95	106,935.25
10	380,487.90	226,721.55	46,816.60	106,949.75
11	380,439.58	226,745.35	46,812.90	106,881.33
12	380,572.42	226,812.68	46,803.33	106,956.40
<b>Average</b>	<b>380,488.31</b>	<b>226,763.81</b>	<b>46,802.08</b>	<b>106,922.42</b>

**Repeatability 2 IOPS - I/O Request Throughput Distribution Graph**

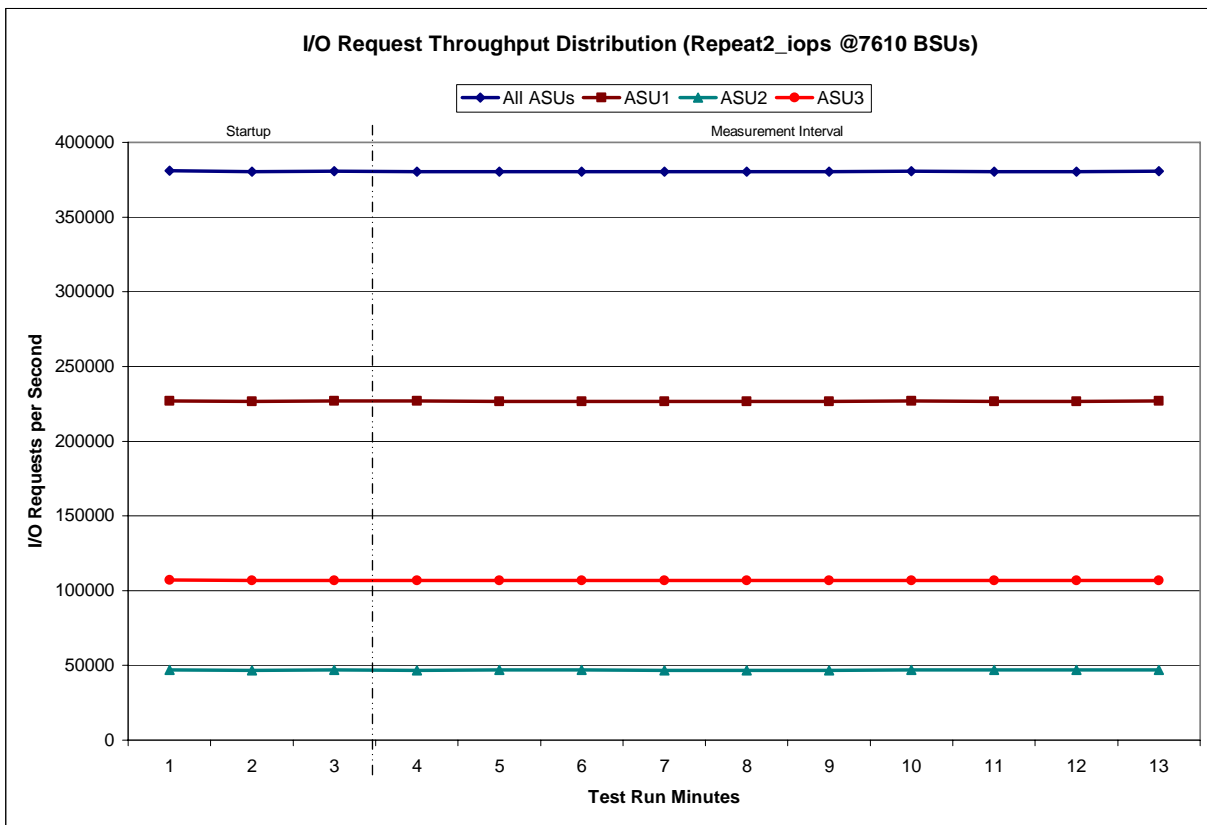

**Repeatability 2 IOPS –Average Response Time (ms) Distribution Data**

7610 BSUs	Start	Stop	Interval	Duration
<i>Start-Up/Ramp-Up</i>	18:45:43	18:48:44	0-2	0:03:01
<i>Measurement Interval</i>	18:48:44	18:58:48	3-12	0:10:04
60 second intervals	All ASUs	ASU1	ASU2	ASU3
0	8.05	8.60	7.98	6.91
1	8.27	8.89	7.99	7.09
2	10.06	10.98	10.01	8.11
3	7.16	7.95	7.06	5.52
4	8.07	8.76	7.89	6.68
5	7.23	7.92	7.00	5.87
6	7.86	8.56	7.64	6.49
7	7.38	8.05	7.15	6.05
8	7.56	8.25	7.34	6.19
9	7.08	7.77	6.88	5.71
10	7.63	8.31	7.43	6.26
11	7.14	7.83	6.89	5.79
12	7.73	8.43	7.47	6.35
<i>Average</i>	<i>7.48</i>	<i>8.18</i>	<i>7.27</i>	<i>6.09</i>

**Repeatability 2 IOPS –Average Response Time (ms) Distribution Graph**

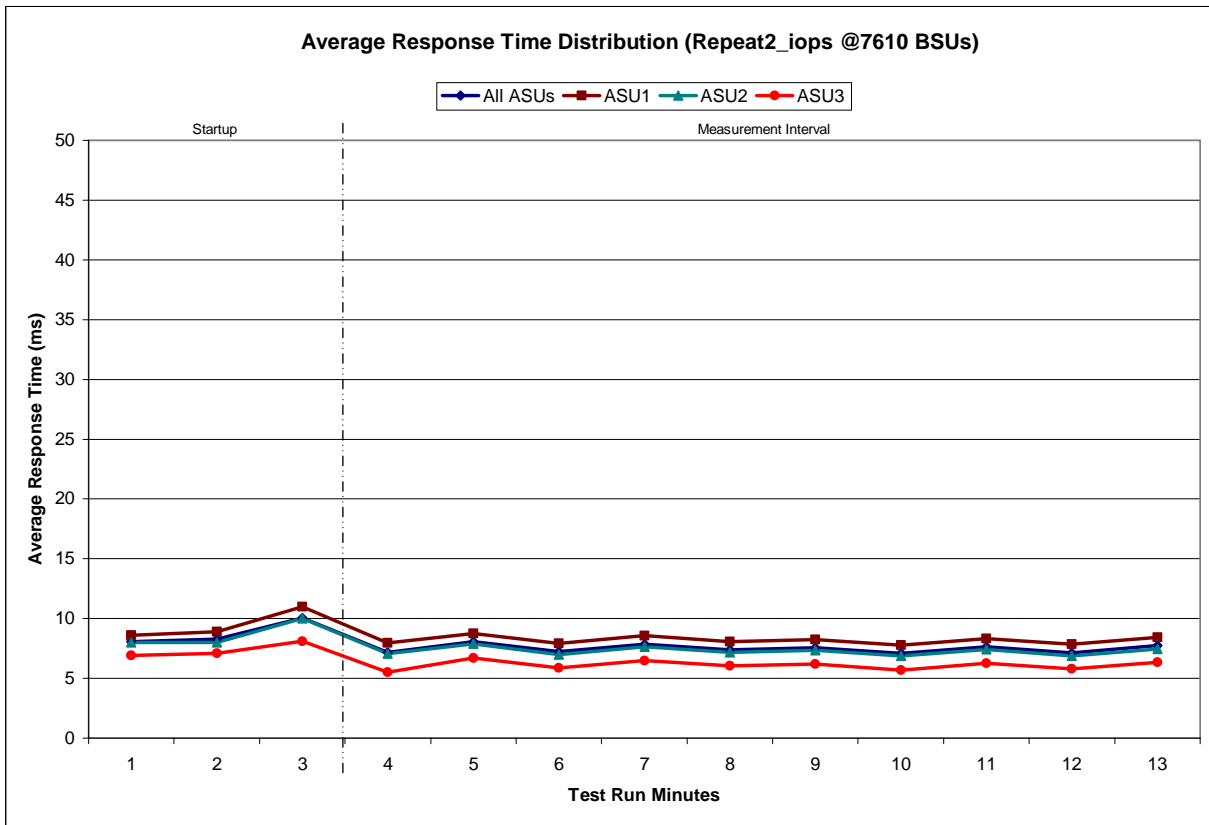

**Repeatability 1 (LRT)  
Measured Intensity Multiplier and Coefficient of Variation**

*Clause 3.4.3*

*IM – Intensity Multiplier: The ratio of I/Os for each I/O stream relative to the total I/Os for all I/O streams (ASU1-1 – ASU3-1) as required by the benchmark specification.*

*Clauses 5.1.10 and 5.3.13.2*

*MIM – Measured Intensity Multiplier: The Measured Intensity Multiplier represents the ratio of measured I/Os for each I/O stream relative to the total I/Os measured for all I/O streams (ASU1-1 – ASU3-1). This value may differ from the corresponding Expected Intensity Multiplier by no more than 5%.*

*Clause 5.3.13.3*

*COV – Coefficient of Variation: This measure of variation for the Measured Intensity Multiplier cannot exceed 0.2.*

	ASU1-1	ASU1-2	ASU1-3	ASU1-4	ASU2-1	ASU2-2	ASU2-3	ASU3-1
<i>IM</i>	<i>0.0350</i>	<i>0.2810</i>	<i>0.0700</i>	<i>0.2100</i>	<i>0.0180</i>	<i>0.0700</i>	<i>0.0350</i>	<i>0.2810</i>
MIM	0.0350	0.2808	0.0700	0.2100	0.0180	0.0700	0.0350	0.2811
COV	0.003	0.001	0.003	0.001	0.004	0.003	0.002	0.001

**Repeatability 1 (IOPS)  
Measured Intensity Multiplier and Coefficient of Variation**

	ASU1-1	ASU1-2	ASU1-3	ASU1-4	ASU2-1	ASU2-2	ASU2-3	ASU3-1
<i>IM</i>	<i>0.0350</i>	<i>0.2810</i>	<i>0.0700</i>	<i>0.2100</i>	<i>0.0180</i>	<i>0.0700</i>	<i>0.0350</i>	<i>0.2810</i>
MIM	0.0350	0.2810	0.0700	0.2100	0.0180	0.0700	0.0350	0.2810
COV	0.001	0.000	0.001	0.000	0.002	0.001	0.001	0.000

**Repeatability 2 (LRT)  
Measured Intensity Multiplier and Coefficient of Variation**

	ASU1-1	ASU1-2	ASU1-3	ASU1-4	ASU2-1	ASU2-2	ASU2-3	ASU3-1
<i>IM</i>	<i>0.0350</i>	<i>0.2810</i>	<i>0.0700</i>	<i>0.2100</i>	<i>0.0180</i>	<i>0.0700</i>	<i>0.0350</i>	<i>0.2810</i>
MIM	0.0350	0.2809	0.0701	0.2100	0.0180	0.0700	0.0351	0.2810
COV	0.002	0.001	0.002	0.001	0.004	0.003	0.005	0.001

**Repeatability 2 (IOPS)**  
**Measured Intensity Multiplier and Coefficient of Variation**

	ASU1-1	ASU1-2	ASU1-3	ASU1-4	ASU2-1	ASU2-2	ASU2-3	ASU3-1
<i>IM</i>	<i>0.0350</i>	<i>0.2810</i>	<i>0.0700</i>	<i>0.2100</i>	<i>0.0180</i>	<i>0.0700</i>	<i>0.0350</i>	<i>0.2810</i>
MIM	0.0350	0.2810	0.0700	0.2100	0.0180	0.0700	0.0350	0.2810
COV	0.001	0.000	0.001	0.000	0.001	0.001	0.001	0.000

## Data Persistence Test

### Clause 6

*The Data Persistence Test demonstrates the Tested Storage Configuration (TSC):*

- *Is capable of maintain data integrity across a power cycle.*
- *Ensures the transfer of data between Logical Volumes and host systems occurs without corruption or loss.*

*The SPC-1 Workload Generator will write 16 block I/O requests at random over the total Addressable Storage Capacity of the TSC for ten (10) minutes at a minimum of 25% of the load used to generate the SPC-1 IOPS™ primary metric. The bit pattern selected to be written to each block as well as the address of the block will be retained in a log file.*

*The Tested Storage Configuration (TSC) will be shutdown and restarted using a power off/power on cycle at the end of the above sequence of write operations. In addition, any caches employing battery backup must be flushed/emptied.*

*The SPC-1 Workload Generator will then use the above log file to verify each block written contains the correct bit pattern.*

### Clause 9.4.3.8

*The following content shall appear in this section of the FDR:*

1. *A listing or screen image of all input parameters supplied to the Workload Generator.*
2. *For the successful Data Persistence Test Run, a table illustrating key results. The content, appearance, and format of this table are specified in Table 9-12. Information displayed in this table shall be obtained from the Test Run Results File referenced below in #3.*
3. *For the successful Data Persistence Test Run, the human readable Test Run Results File produced by the Workload Generator.*

## SPC-1 Workload Generator Input Parameters

The SPC-1 Workload Generator input parameters for the Sustainability, IOPS, Response Time Ramp, Repeatability, and Persistence Test Runs are documented in “Appendix E: SPC-1 Workload Generator Input Parameters” on Page 109.

## Data Persistence Test Results File

A link to each test result file generated from each Data Persistence Test is listed below.

[Persistence 1 Test Results File](#)

[Persistence 2 Test Results File](#)

**Data Persistence Test Results**

<b>Data Persistence Test Results</b>	
Data Persistence Test Run Number: 1	
Total Number of Logical Blocks Written	1,897,736
Total Number of Logical Blocks Verified	1,878,511
Total Number of Logical Blocks that Failed Verification	0
Time Duration for Writing Test Logical Blocks	5 minutes
Size in Bytes of each Logical Block	1024
Number of Failed I/O Requests in the process of the Test	0

If approved by the SPC Auditor, the SPC-2 Persistence Test may be used to meet the SPC-1 persistence requirements. Both the SPC-1 and SPC-2 Persistence Tests provide the same level of functionality and verification of data integrity. The SPC-2 Persistence Test may be easily configured to address an SPC-1 storage configuration. The SPC-2 Persistence Test extends the size of storage configurations that may be tested and significantly reduces the test duration of such configurations.

The SPC-2 Persistence Test was approved for use in this set of audited measurements.

In some cases the same address was the target of multiple writes, which resulted in more Logical Blocks Written than Logical Blocks Verified. In the case of multiple writes to the same address, the pattern written and verified must be associated with the last write to that address.

## **PRICED STORAGE CONFIGURATION AVAILABILITY DATE**

### **Clause 9.2.4.9**

*The committed delivery data for general availability (Availability Date) of all products that comprise the Priced Storage Configuration must be reported. When the Priced Storage Configuration includes products or components with different availability dates, the reported Availability Date for the Priced Storage Configuration must be the date at which all components are committed to be available.*

The IBM System Storage SAN Volume Controller v5.1 (6-node cluster with 2 IBM DS8700s) as documented in this Full Disclosure Report is currently available for customer purchase and shipment.

## **PRICING INFORMATION**

### **Clause 9.4.3.3.6**

*The Executive Summary shall contain a pricing spreadsheet as documented in Clause 8.3.1.*

Pricing information may be found in the Priced Storage Configuration Pricing section on page 14.

## **TESTED STORAGE CONFIGURATION (TSC) AND PRICED STORAGE CONFIGURATION DIFFERENCES**

### **Clause 9.4.3.3.7**

*The Executive Summary shall contain a pricing list of all differences between the Tested Storage Configuration (TSC) and the Priced Storage Configuration.*

A list of all differences between the Tested Storage Configuration (TSC) and Priced Storage Configuration may be found in the Executive Summary portion of this document on page 14.

## **ANOMALIES OR IRREGULARITIES**

### **Clause 9.4.3.10**

*The FDR shall include a clear and complete description of any anomalies or irregularities encountered in the course of executing the SPC-1 benchmark that may in any way call into question the accuracy, verifiability, or authenticity of information published in this FDR.*

There were no anomalies or irregularities encountered during the SPC-1 Remote Audit of the IBM System Storage SAN Volume Controller v5.1 (6-node cluster with 2 IBM DS8700s).



## **APPENDIX A: SPC-1 GLOSSARY**

### **“Decimal” (*powers of ten*) Measurement Units**

In the storage industry, the terms “kilo”, “mega”, “giga”, “tera”, “peta”, and “exa” are commonly used prefixes for computing performance and capacity. For the purposes of the SPC workload definitions, all of the following terms are defined in “powers of ten” measurement units.

- A kilobyte (KB) is equal to 1,000 ( $10^3$ ) bytes.
- A megabyte (MB) is equal to 1,000,000 ( $10^6$ ) bytes.
- A gigabyte (GB) is equal to 1,000,000,000 ( $10^9$ ) bytes.
- A terabyte (TB) is equal to 1,000,000,000,000 ( $10^{12}$ ) bytes.
- A petabyte (PB) is equal to 1,000,000,000,000,000 ( $10^{15}$ ) bytes
- An exabyte (EB) is equal to 1,000,000,000,000,000,000 ( $10^{18}$ ) bytes

### **“Binary” (*powers of two*) Measurement Units**

The sizes reported by many operating system components use “powers of two” measurement units rather than “power of ten” units. The following standardized definitions and terms are also valid and may be used in this document.

- A kibibyte (KiB) is equal to 1,024 ( $2^{10}$ ) bytes.
- A mebibyte (MiB) is equal to 1,048,576 ( $2^{20}$ ) bytes.
- A gibibyte (GiB) is equal to 1,073,741,824 ( $2^{30}$ ) bytes.
- A tebibyte (TiB) is equal to 1,099,511,627,776 ( $2^{40}$ ) bytes.
- A pebibyte (PiB) is equal to 1,125,899,906,842,624 ( $2^{50}$ ) bytes.
- An exbibyte (EiB) is equal to 1,152,921,504,606,846,967 ( $2^{60}$ ) bytes.

## **SPC-1 Data Repository Definitions**

**Total ASU Capacity:** The total storage capacity read and written in the course of executing the SPC-1 benchmark.

**Application Storage Unit (ASU):** The logical interface between the storage and SPC-1 Workload Generator. The three ASUs (Data, User, and Log) are typically implemented on one or more Logical Volume.

**Logical Volume:** The division of Addressable Storage Capacity into individually addressable logical units of storage used in the SPC-1 benchmark. Each Logical Volume is implemented as a single, contiguous address space.

**Addressable Storage Capacity:** The total storage (sum of Logical Volumes) that can be read and written by application programs such as the SPC-1 Workload Generator.

**Configured Storage Capacity:** This capacity includes the Addressable Storage Capacity and any other storage (parity disks, hot spares, etc.) necessary to implement the Addressable Storage Capacity.

**Physical Storage Capacity:** The formatted capacity of all storage devices physically present in the Tested Storage Configuration (TSC).

**Data Protection Overhead:** The storage capacity required to implement the selected level of data protection.

**Required Storage:** The amount of Configured Storage Capacity required to implement the Addressable Storage Configuration, excluding the storage required for the three ASUs.

**Global Storage Overhead:** The amount of Physical Storage Capacity that is required for storage subsystem use and unavailable for use by application programs.

**Total Unused Storage:** The amount of storage capacity available for use by application programs but not included in the Total ASU Capacity.

## SPC-1 Data Protection Levels

**Protected:** This level will ensure data protection in the event of a single point of failure of any configured storage device. A brief description of the data protection utilized is included in the Executive Summary.

**Unprotected:** No claim of data protection is asserted in the event of a single point of failure.

## SPC-1 Test Execution Definitions

**Average Response Time:** The sum of the Response Times for all Measured I/O Requests divided by the total number of Measured I/O Requests.

**Completed I/O Request:** An I/O Request with a Start Time and a Completion Time (see "I/O Completion Types" below).

**Completion Time:** The time recorded by the Workload Generator when an I/O Request is satisfied by the TSC as signaled by System Software.

**Data Rate:** The data transferred in all Measured I/O Requests in an SPC-1 Test Run divided by the length of the Test Run in seconds.

**Expected I/O Count:** For any given I/O Stream and Test Phase, the product of 50 times the BSU level, the duration of the Test Phase in seconds, and the Intensity Multiplier for that I/O Stream.

**Failed I/O Request:** Any I/O Request issued by the Workload Generator that could not be completed or was signaled as failed by System Software. A Failed I/O Request has no Completion Time (see “I/O Completion Types” below).

**I/O Request Throughput:** The total number of Measured I/O requests in an SPC-1 Test Run divided by the duration of the Measurement Interval in seconds.

**In-Flight I/O Request:** An I/O Request issued by the I/O Command Generator to the TSC that has a recorded Start Time, but does not complete within the Measurement Interval (see “I/O Completion Types” below).

**Measured I/O Request:** A Completed I/O Request with a Completion Time occurring within the Measurement Interval (see “I/O Completion Types” below).

**Measured Intensity Multiplier:** The percentage of all Measured I/O Requests that were issued by a given I/O Stream.

**Measurement Interval:** The finite and contiguous time period, after the TSC has reached Steady State, when data is collected by a Test Sponsor to generate an SPC-1 test result or support an SPC-1 test result.

**Ramp-Up:** The time required for the Benchmark Configuration (BC) to produce Steady State throughput after the Workload Generator begins submitting I/O Requests to the TSC for execution.

**Ramp-Down:** The time required for the BC to complete all I/O Requests issued by the Workload Generator. The Ramp-Down period begins when the Workload Generator ceases to issue new I/O Requests to the TSC.

**Response Time:** The Response Time of a Measured I/O Request is its Completion Time minus its Start Time.

**Start Time:** The time recorded by the Workload Generator when an I/O Request is submitted, by the Workload Generator, to the System Software for execution on the Tested Storage Configuration (TSC).

**Start-Up:** The period that begins after the Workload Generator starts to submit I/O requests to the TSC and ends at the beginning of the Measurement Interval.

**Shut-Down:** The period between the end of the Measurement Interval and the time when all I/O Requests issued by the Workload Generator have completed or failed.

**Steady State:** The consistent and sustainable throughput of the TSC. During this period the load presented to the TSC by the Workload Generator is constant.

**Test:** A collection of Test Phases and or Test Runs sharing a common objective.

**Test Run:** The execution of SPC-1 for the purpose of producing or supporting an SPC-1 test result. SPC-1 Test Runs may have a finite and measured Ramp-Up period, Start-Up

period, Shut-Down period, and Ramp-Down period as illustrated in the “SPC-1 Test Run Components” below. All SPC-1 Test Runs shall have a Steady State period and a Measurement Interval.

**Test Phase:** A collection of one or more SPC-1 Test Runs sharing a common objective and intended to be run in a specific sequence.

### I/O Completion Types

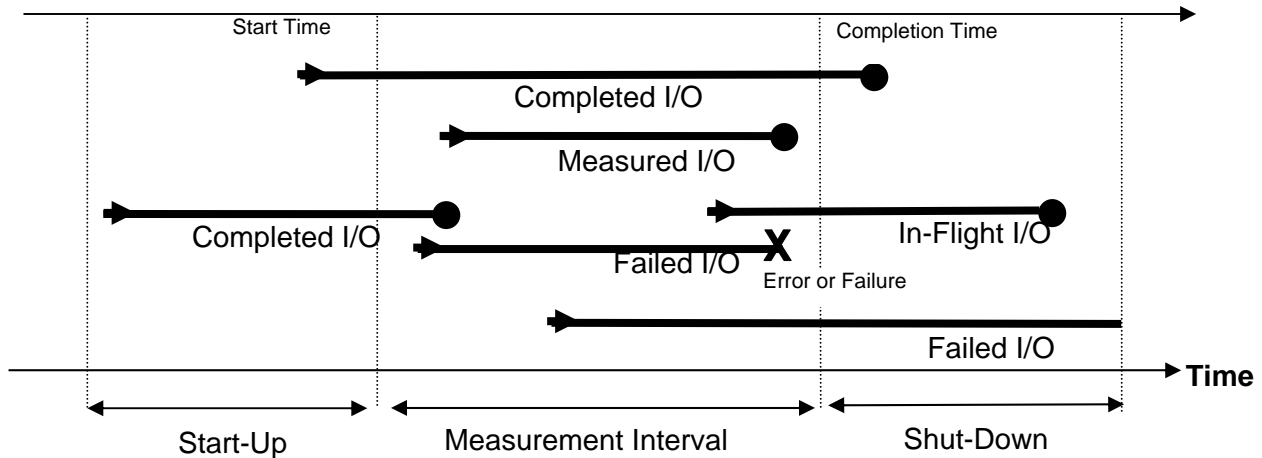

### SPC-1 Test Run Components

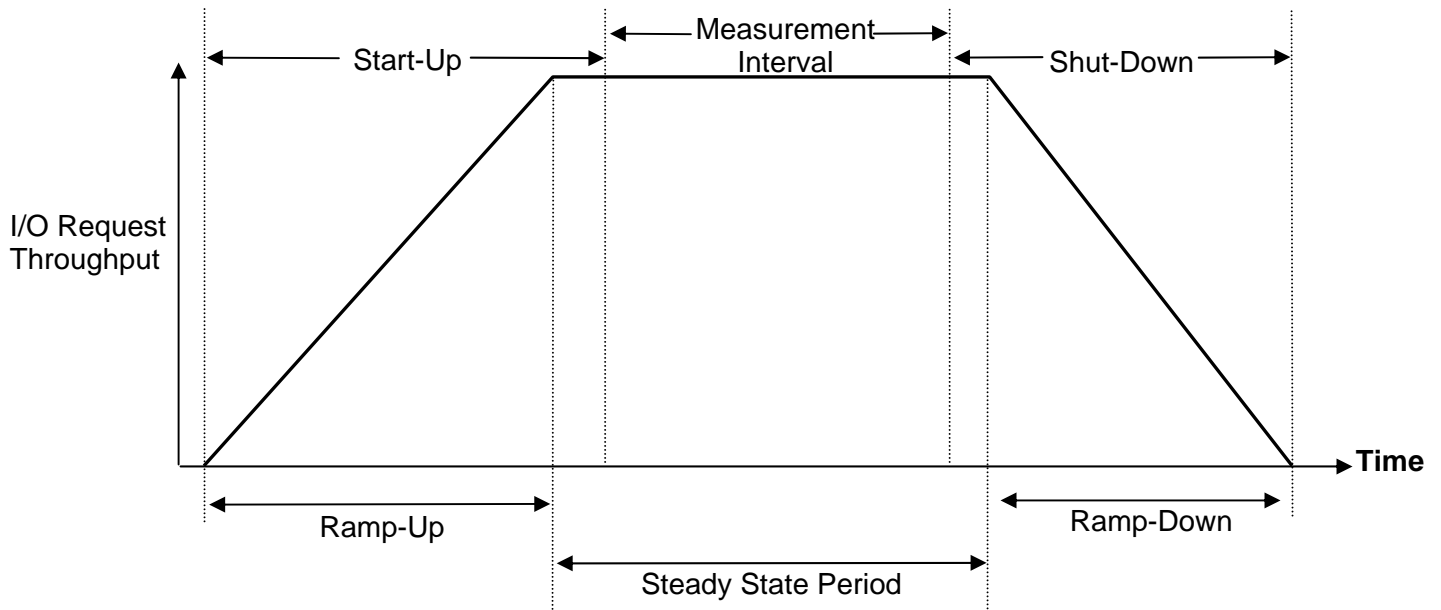

**APPENDIX B: CUSTOMER TUNABLE PARAMETERS AND OPTIONS**

The AIX queue depth was set to 8 from a default value of 20.

## **APPENDIX C: TESTED STORAGE CONFIGURATION (TSC) CREATION**

### **DS8700 Configuration Steps**

The DS8700 portion of the configuration is implemented using DSCLI, a DS8700-specific script execution tool. DSCLI was used to carry out the following configuration steps.

#### **Create extent pools**

The `step1_extpool.txt` script defines a set of 128 extent pool names P0, P1, ..., P127. The names are used in subsequent scripts.

#### **step1\_extpool.txt**

```
mkextpool -dev IBM.2107-75PB501 -rankgrp 0 -stgtype fb P0
mkextpool -dev IBM.2107-75PB501 -rankgrp 1 -stgtype fb P1
mkextpool -dev IBM.2107-75PB501 -rankgrp 0 -stgtype fb P2
mkextpool -dev IBM.2107-75PB501 -rankgrp 1 -stgtype fb P3
mkextpool -dev IBM.2107-75PB501 -rankgrp 0 -stgtype fb P4
mkextpool -dev IBM.2107-75PB501 -rankgrp 1 -stgtype fb P5
mkextpool -dev IBM.2107-75PB501 -rankgrp 0 -stgtype fb P6
mkextpool -dev IBM.2107-75PB501 -rankgrp 1 -stgtype fb P7
mkextpool -dev IBM.2107-75PB501 -rankgrp 0 -stgtype fb P8
mkextpool -dev IBM.2107-75PB501 -rankgrp 1 -stgtype fb P9
mkextpool -dev IBM.2107-75PB501 -rankgrp 0 -stgtype fb P10
mkextpool -dev IBM.2107-75PB501 -rankgrp 1 -stgtype fb P11
mkextpool -dev IBM.2107-75PB501 -rankgrp 0 -stgtype fb P12
mkextpool -dev IBM.2107-75PB501 -rankgrp 1 -stgtype fb P13
mkextpool -dev IBM.2107-75PB501 -rankgrp 0 -stgtype fb P14
mkextpool -dev IBM.2107-75PB501 -rankgrp 1 -stgtype fb P15
mkextpool -dev IBM.2107-75PB501 -rankgrp 0 -stgtype fb P16
mkextpool -dev IBM.2107-75PB501 -rankgrp 1 -stgtype fb P17
mkextpool -dev IBM.2107-75PB501 -rankgrp 0 -stgtype fb P18
mkextpool -dev IBM.2107-75PB501 -rankgrp 1 -stgtype fb P19
mkextpool -dev IBM.2107-75PB501 -rankgrp 0 -stgtype fb P20
mkextpool -dev IBM.2107-75PB501 -rankgrp 1 -stgtype fb P21
mkextpool -dev IBM.2107-75PB501 -rankgrp 0 -stgtype fb P22
mkextpool -dev IBM.2107-75PB501 -rankgrp 1 -stgtype fb P23
mkextpool -dev IBM.2107-75PB501 -rankgrp 0 -stgtype fb P24
mkextpool -dev IBM.2107-75PB501 -rankgrp 1 -stgtype fb P25
mkextpool -dev IBM.2107-75PB501 -rankgrp 0 -stgtype fb P26
mkextpool -dev IBM.2107-75PB501 -rankgrp 1 -stgtype fb P27
mkextpool -dev IBM.2107-75PB501 -rankgrp 0 -stgtype fb P28
mkextpool -dev IBM.2107-75PB501 -rankgrp 1 -stgtype fb P29
mkextpool -dev IBM.2107-75PB501 -rankgrp 0 -stgtype fb P30
mkextpool -dev IBM.2107-75PB501 -rankgrp 1 -stgtype fb P31
mkextpool -dev IBM.2107-75PB501 -rankgrp 0 -stgtype fb P32
mkextpool -dev IBM.2107-75PB501 -rankgrp 1 -stgtype fb P33
mkextpool -dev IBM.2107-75PB501 -rankgrp 0 -stgtype fb P34
mkextpool -dev IBM.2107-75PB501 -rankgrp 1 -stgtype fb P35
mkextpool -dev IBM.2107-75PB501 -rankgrp 0 -stgtype fb P36
mkextpool -dev IBM.2107-75PB501 -rankgrp 1 -stgtype fb P37
mkextpool -dev IBM.2107-75PB501 -rankgrp 0 -stgtype fb P38
mkextpool -dev IBM.2107-75PB501 -rankgrp 1 -stgtype fb P39
mkextpool -dev IBM.2107-75PB501 -rankgrp 0 -stgtype fb P40
mkextpool -dev IBM.2107-75PB501 -rankgrp 1 -stgtype fb P41
mkextpool -dev IBM.2107-75PB501 -rankgrp 0 -stgtype fb P42
mkextpool -dev IBM.2107-75PB501 -rankgrp 1 -stgtype fb P43
mkextpool -dev IBM.2107-75PB501 -rankgrp 0 -stgtype fb P44
```

```
mkextpool -dev IBM.2107-75PB501 -rankgrp 1 -stgtype fb P45
mkextpool -dev IBM.2107-75PB501 -rankgrp 0 -stgtype fb P46
mkextpool -dev IBM.2107-75PB501 -rankgrp 1 -stgtype fb P47
mkextpool -dev IBM.2107-75PB501 -rankgrp 0 -stgtype fb P48
mkextpool -dev IBM.2107-75PB501 -rankgrp 1 -stgtype fb P49
mkextpool -dev IBM.2107-75PB501 -rankgrp 0 -stgtype fb P50
mkextpool -dev IBM.2107-75PB501 -rankgrp 1 -stgtype fb P51
mkextpool -dev IBM.2107-75PB501 -rankgrp 0 -stgtype fb P52
mkextpool -dev IBM.2107-75PB501 -rankgrp 1 -stgtype fb P53
mkextpool -dev IBM.2107-75PB501 -rankgrp 0 -stgtype fb P54
mkextpool -dev IBM.2107-75PB501 -rankgrp 1 -stgtype fb P55
mkextpool -dev IBM.2107-75PB501 -rankgrp 0 -stgtype fb P56
mkextpool -dev IBM.2107-75PB501 -rankgrp 1 -stgtype fb P57
mkextpool -dev IBM.2107-75PB501 -rankgrp 0 -stgtype fb P58
mkextpool -dev IBM.2107-75PB501 -rankgrp 1 -stgtype fb P59
mkextpool -dev IBM.2107-75PB501 -rankgrp 0 -stgtype fb P60
mkextpool -dev IBM.2107-75PB501 -rankgrp 1 -stgtype fb P61
mkextpool -dev IBM.2107-75PB501 -rankgrp 0 -stgtype fb P62
mkextpool -dev IBM.2107-75PB501 -rankgrp 1 -stgtype fb P63
mkextpool -dev IBM.2107-75PB501 -rankgrp 0 -stgtype fb P64
mkextpool -dev IBM.2107-75PB501 -rankgrp 1 -stgtype fb P65
mkextpool -dev IBM.2107-75PB501 -rankgrp 0 -stgtype fb P66
mkextpool -dev IBM.2107-75PB501 -rankgrp 1 -stgtype fb P67
mkextpool -dev IBM.2107-75PB501 -rankgrp 0 -stgtype fb P68
mkextpool -dev IBM.2107-75PB501 -rankgrp 1 -stgtype fb P69
mkextpool -dev IBM.2107-75PB501 -rankgrp 0 -stgtype fb P70
mkextpool -dev IBM.2107-75PB501 -rankgrp 1 -stgtype fb P71
mkextpool -dev IBM.2107-75PB501 -rankgrp 0 -stgtype fb P72
mkextpool -dev IBM.2107-75PB501 -rankgrp 1 -stgtype fb P73
mkextpool -dev IBM.2107-75PB501 -rankgrp 0 -stgtype fb P74
mkextpool -dev IBM.2107-75PB501 -rankgrp 1 -stgtype fb P75
mkextpool -dev IBM.2107-75PB501 -rankgrp 0 -stgtype fb P76
mkextpool -dev IBM.2107-75PB501 -rankgrp 1 -stgtype fb P77
mkextpool -dev IBM.2107-75PB501 -rankgrp 0 -stgtype fb P78
mkextpool -dev IBM.2107-75PB501 -rankgrp 1 -stgtype fb P79
mkextpool -dev IBM.2107-75PB501 -rankgrp 0 -stgtype fb P80
mkextpool -dev IBM.2107-75PB501 -rankgrp 1 -stgtype fb P81
mkextpool -dev IBM.2107-75PB501 -rankgrp 0 -stgtype fb P82
mkextpool -dev IBM.2107-75PB501 -rankgrp 1 -stgtype fb P83
mkextpool -dev IBM.2107-75PB501 -rankgrp 0 -stgtype fb P84
mkextpool -dev IBM.2107-75PB501 -rankgrp 1 -stgtype fb P85
mkextpool -dev IBM.2107-75PB501 -rankgrp 0 -stgtype fb P86
mkextpool -dev IBM.2107-75PB501 -rankgrp 1 -stgtype fb P87
mkextpool -dev IBM.2107-75PB501 -rankgrp 0 -stgtype fb P88
mkextpool -dev IBM.2107-75PB501 -rankgrp 1 -stgtype fb P89
mkextpool -dev IBM.2107-75PB501 -rankgrp 0 -stgtype fb P90
mkextpool -dev IBM.2107-75PB501 -rankgrp 1 -stgtype fb P91
mkextpool -dev IBM.2107-75PB501 -rankgrp 0 -stgtype fb P92
mkextpool -dev IBM.2107-75PB501 -rankgrp 1 -stgtype fb P93
mkextpool -dev IBM.2107-75PB501 -rankgrp 0 -stgtype fb P94
mkextpool -dev IBM.2107-75PB501 -rankgrp 1 -stgtype fb P95
mkextpool -dev IBM.2107-75PB501 -rankgrp 0 -stgtype fb P96
mkextpool -dev IBM.2107-75PB501 -rankgrp 1 -stgtype fb P97
mkextpool -dev IBM.2107-75PB501 -rankgrp 0 -stgtype fb P98
mkextpool -dev IBM.2107-75PB501 -rankgrp 1 -stgtype fb P99
mkextpool -dev IBM.2107-75PB501 -rankgrp 0 -stgtype fb P100
mkextpool -dev IBM.2107-75PB501 -rankgrp 1 -stgtype fb P101
mkextpool -dev IBM.2107-75PB501 -rankgrp 0 -stgtype fb P102
mkextpool -dev IBM.2107-75PB501 -rankgrp 1 -stgtype fb P103
mkextpool -dev IBM.2107-75PB501 -rankgrp 0 -stgtype fb P104
mkextpool -dev IBM.2107-75PB501 -rankgrp 1 -stgtype fb P105
mkextpool -dev IBM.2107-75PB501 -rankgrp 0 -stgtype fb P106
mkextpool -dev IBM.2107-75PB501 -rankgrp 1 -stgtype fb P107
```

```
mkextpool -dev IBM.2107-75PB501 -rankgrp 0 -stgtype fb P108
mkextpool -dev IBM.2107-75PB501 -rankgrp 1 -stgtype fb P109
mkextpool -dev IBM.2107-75PB501 -rankgrp 0 -stgtype fb P110
mkextpool -dev IBM.2107-75PB501 -rankgrp 1 -stgtype fb P111
mkextpool -dev IBM.2107-75PB501 -rankgrp 0 -stgtype fb P112
mkextpool -dev IBM.2107-75PB501 -rankgrp 1 -stgtype fb P113
mkextpool -dev IBM.2107-75PB501 -rankgrp 0 -stgtype fb P114
mkextpool -dev IBM.2107-75PB501 -rankgrp 1 -stgtype fb P115
mkextpool -dev IBM.2107-75PB501 -rankgrp 0 -stgtype fb P116
mkextpool -dev IBM.2107-75PB501 -rankgrp 1 -stgtype fb P117
mkextpool -dev IBM.2107-75PB501 -rankgrp 0 -stgtype fb P118
mkextpool -dev IBM.2107-75PB501 -rankgrp 1 -stgtype fb P119
mkextpool -dev IBM.2107-75PB501 -rankgrp 0 -stgtype fb P120
mkextpool -dev IBM.2107-75PB501 -rankgrp 1 -stgtype fb P121
mkextpool -dev IBM.2107-75PB501 -rankgrp 0 -stgtype fb P122
mkextpool -dev IBM.2107-75PB501 -rankgrp 1 -stgtype fb P123
mkextpool -dev IBM.2107-75PB501 -rankgrp 0 -stgtype fb P124
mkextpool -dev IBM.2107-75PB501 -rankgrp 1 -stgtype fb P125
mkextpool -dev IBM.2107-75PB501 -rankgrp 0 -stgtype fb P126
mkextpool -dev IBM.2107-75PB501 -rankgrp 1 -stgtype fb P127
```

### Create the RAID-10 ranks

The `step2_makearray.txt` script groups the physical volumes into 128 RAID-10 arrays and the system automatically generates a set of array names, A0-A127.

#### step2\_makearray.txt

```
mkarray -dev IBM.2107-75PB501 -raidtype 10 -arsite S1
mkarray -dev IBM.2107-75PB501 -raidtype 10 -arsite S2
mkarray -dev IBM.2107-75PB501 -raidtype 10 -arsite S3
mkarray -dev IBM.2107-75PB501 -raidtype 10 -arsite S4
mkarray -dev IBM.2107-75PB501 -raidtype 10 -arsite S5
mkarray -dev IBM.2107-75PB501 -raidtype 10 -arsite S6
mkarray -dev IBM.2107-75PB501 -raidtype 10 -arsite S7
mkarray -dev IBM.2107-75PB501 -raidtype 10 -arsite S8
mkarray -dev IBM.2107-75PB501 -raidtype 10 -arsite S9
mkarray -dev IBM.2107-75PB501 -raidtype 10 -arsite S10
mkarray -dev IBM.2107-75PB501 -raidtype 10 -arsite S11
mkarray -dev IBM.2107-75PB501 -raidtype 10 -arsite S12
mkarray -dev IBM.2107-75PB501 -raidtype 10 -arsite S13
mkarray -dev IBM.2107-75PB501 -raidtype 10 -arsite S14
mkarray -dev IBM.2107-75PB501 -raidtype 10 -arsite S15
mkarray -dev IBM.2107-75PB501 -raidtype 10 -arsite S16
mkarray -dev IBM.2107-75PB501 -raidtype 10 -arsite S17
mkarray -dev IBM.2107-75PB501 -raidtype 10 -arsite S18
mkarray -dev IBM.2107-75PB501 -raidtype 10 -arsite S19
mkarray -dev IBM.2107-75PB501 -raidtype 10 -arsite S20
mkarray -dev IBM.2107-75PB501 -raidtype 10 -arsite S21
mkarray -dev IBM.2107-75PB501 -raidtype 10 -arsite S22
mkarray -dev IBM.2107-75PB501 -raidtype 10 -arsite S23
mkarray -dev IBM.2107-75PB501 -raidtype 10 -arsite S24
mkarray -dev IBM.2107-75PB501 -raidtype 10 -arsite S25
mkarray -dev IBM.2107-75PB501 -raidtype 10 -arsite S26
mkarray -dev IBM.2107-75PB501 -raidtype 10 -arsite S27
mkarray -dev IBM.2107-75PB501 -raidtype 10 -arsite S28
mkarray -dev IBM.2107-75PB501 -raidtype 10 -arsite S29
mkarray -dev IBM.2107-75PB501 -raidtype 10 -arsite S30
mkarray -dev IBM.2107-75PB501 -raidtype 10 -arsite S31
mkarray -dev IBM.2107-75PB501 -raidtype 10 -arsite S32
mkarray -dev IBM.2107-75PB501 -raidtype 10 -arsite S33
mkarray -dev IBM.2107-75PB501 -raidtype 10 -arsite S34
```



```
mkarray -dev IBM.2107-75PB501 -raidtype 10 -arsite S35
mkarray -dev IBM.2107-75PB501 -raidtype 10 -arsite S36
mkarray -dev IBM.2107-75PB501 -raidtype 10 -arsite S37
mkarray -dev IBM.2107-75PB501 -raidtype 10 -arsite S38
mkarray -dev IBM.2107-75PB501 -raidtype 10 -arsite S39
mkarray -dev IBM.2107-75PB501 -raidtype 10 -arsite S40
mkarray -dev IBM.2107-75PB501 -raidtype 10 -arsite S41
mkarray -dev IBM.2107-75PB501 -raidtype 10 -arsite S42
mkarray -dev IBM.2107-75PB501 -raidtype 10 -arsite S43
mkarray -dev IBM.2107-75PB501 -raidtype 10 -arsite S44
mkarray -dev IBM.2107-75PB501 -raidtype 10 -arsite S45
mkarray -dev IBM.2107-75PB501 -raidtype 10 -arsite S46
mkarray -dev IBM.2107-75PB501 -raidtype 10 -arsite S47
mkarray -dev IBM.2107-75PB501 -raidtype 10 -arsite S48
mkarray -dev IBM.2107-75PB501 -raidtype 10 -arsite S49
mkarray -dev IBM.2107-75PB501 -raidtype 10 -arsite S50
mkarray -dev IBM.2107-75PB501 -raidtype 10 -arsite S51
mkarray -dev IBM.2107-75PB501 -raidtype 10 -arsite S52
mkarray -dev IBM.2107-75PB501 -raidtype 10 -arsite S53
mkarray -dev IBM.2107-75PB501 -raidtype 10 -arsite S54
mkarray -dev IBM.2107-75PB501 -raidtype 10 -arsite S55
mkarray -dev IBM.2107-75PB501 -raidtype 10 -arsite S56
mkarray -dev IBM.2107-75PB501 -raidtype 10 -arsite S57
mkarray -dev IBM.2107-75PB501 -raidtype 10 -arsite S58
mkarray -dev IBM.2107-75PB501 -raidtype 10 -arsite S59
mkarray -dev IBM.2107-75PB501 -raidtype 10 -arsite S60
mkarray -dev IBM.2107-75PB501 -raidtype 10 -arsite S61
mkarray -dev IBM.2107-75PB501 -raidtype 10 -arsite S62
mkarray -dev IBM.2107-75PB501 -raidtype 10 -arsite S63
mkarray -dev IBM.2107-75PB501 -raidtype 10 -arsite S64
mkarray -dev IBM.2107-75PB501 -raidtype 10 -arsite S65
mkarray -dev IBM.2107-75PB501 -raidtype 10 -arsite S66
mkarray -dev IBM.2107-75PB501 -raidtype 10 -arsite S67
mkarray -dev IBM.2107-75PB501 -raidtype 10 -arsite S68
mkarray -dev IBM.2107-75PB501 -raidtype 10 -arsite S69
mkarray -dev IBM.2107-75PB501 -raidtype 10 -arsite S70
mkarray -dev IBM.2107-75PB501 -raidtype 10 -arsite S71
mkarray -dev IBM.2107-75PB501 -raidtype 10 -arsite S72
mkarray -dev IBM.2107-75PB501 -raidtype 10 -arsite S73
mkarray -dev IBM.2107-75PB501 -raidtype 10 -arsite S74
mkarray -dev IBM.2107-75PB501 -raidtype 10 -arsite S75
mkarray -dev IBM.2107-75PB501 -raidtype 10 -arsite S76
mkarray -dev IBM.2107-75PB501 -raidtype 10 -arsite S77
mkarray -dev IBM.2107-75PB501 -raidtype 10 -arsite S78
mkarray -dev IBM.2107-75PB501 -raidtype 10 -arsite S79
mkarray -dev IBM.2107-75PB501 -raidtype 10 -arsite S80
mkarray -dev IBM.2107-75PB501 -raidtype 10 -arsite S81
mkarray -dev IBM.2107-75PB501 -raidtype 10 -arsite S82
mkarray -dev IBM.2107-75PB501 -raidtype 10 -arsite S83
mkarray -dev IBM.2107-75PB501 -raidtype 10 -arsite S84
mkarray -dev IBM.2107-75PB501 -raidtype 10 -arsite S85
mkarray -dev IBM.2107-75PB501 -raidtype 10 -arsite S86
mkarray -dev IBM.2107-75PB501 -raidtype 10 -arsite S87
mkarray -dev IBM.2107-75PB501 -raidtype 10 -arsite S88
mkarray -dev IBM.2107-75PB501 -raidtype 10 -arsite S89
mkarray -dev IBM.2107-75PB501 -raidtype 10 -arsite S90
mkarray -dev IBM.2107-75PB501 -raidtype 10 -arsite S91
mkarray -dev IBM.2107-75PB501 -raidtype 10 -arsite S92
mkarray -dev IBM.2107-75PB501 -raidtype 10 -arsite S93
mkarray -dev IBM.2107-75PB501 -raidtype 10 -arsite S94
mkarray -dev IBM.2107-75PB501 -raidtype 10 -arsite S95
mkarray -dev IBM.2107-75PB501 -raidtype 10 -arsite S96
mkarray -dev IBM.2107-75PB501 -raidtype 10 -arsite S97
```

```
mkarray -dev IBM.2107-75PB501 -raidtype 10 -arsite S98
mkarray -dev IBM.2107-75PB501 -raidtype 10 -arsite S99
mkarray -dev IBM.2107-75PB501 -raidtype 10 -arsite S100
mkarray -dev IBM.2107-75PB501 -raidtype 10 -arsite S101
mkarray -dev IBM.2107-75PB501 -raidtype 10 -arsite S102
mkarray -dev IBM.2107-75PB501 -raidtype 10 -arsite S103
mkarray -dev IBM.2107-75PB501 -raidtype 10 -arsite S104
mkarray -dev IBM.2107-75PB501 -raidtype 10 -arsite S105
mkarray -dev IBM.2107-75PB501 -raidtype 10 -arsite S106
mkarray -dev IBM.2107-75PB501 -raidtype 10 -arsite S107
mkarray -dev IBM.2107-75PB501 -raidtype 10 -arsite S108
mkarray -dev IBM.2107-75PB501 -raidtype 10 -arsite S109
mkarray -dev IBM.2107-75PB501 -raidtype 10 -arsite S110
mkarray -dev IBM.2107-75PB501 -raidtype 10 -arsite S111
mkarray -dev IBM.2107-75PB501 -raidtype 10 -arsite S112
mkarray -dev IBM.2107-75PB501 -raidtype 10 -arsite S113
mkarray -dev IBM.2107-75PB501 -raidtype 10 -arsite S114
mkarray -dev IBM.2107-75PB501 -raidtype 10 -arsite S115
mkarray -dev IBM.2107-75PB501 -raidtype 10 -arsite S116
mkarray -dev IBM.2107-75PB501 -raidtype 10 -arsite S117
mkarray -dev IBM.2107-75PB501 -raidtype 10 -arsite S118
mkarray -dev IBM.2107-75PB501 -raidtype 10 -arsite S119
mkarray -dev IBM.2107-75PB501 -raidtype 10 -arsite S120
mkarray -dev IBM.2107-75PB501 -raidtype 10 -arsite S121
mkarray -dev IBM.2107-75PB501 -raidtype 10 -arsite S122
mkarray -dev IBM.2107-75PB501 -raidtype 10 -arsite S123
mkarray -dev IBM.2107-75PB501 -raidtype 10 -arsite S124
mkarray -dev IBM.2107-75PB501 -raidtype 10 -arsite S125
mkarray -dev IBM.2107-75PB501 -raidtype 10 -arsite S126
mkarray -dev IBM.2107-75PB501 -raidtype 10 -arsite S127
mkarray -dev IBM.2107-75PB501 -raidtype 10 -arsite S128
```

The **step3\_mkranks.txt** script, defines the arrays, A0-A127, as 128 open system ranks, R0-R127. As in the previous script, the rank names are assigned by the system.

### step3\_makeranks.txt

```
mkrank -dev IBM.2107-75PB501 -array A0 -stgtype fb -extpool P0
mkrank -dev IBM.2107-75PB501 -array A1 -stgtype fb -extpool P1
mkrank -dev IBM.2107-75PB501 -array A2 -stgtype fb -extpool P2
mkrank -dev IBM.2107-75PB501 -array A3 -stgtype fb -extpool P3
mkrank -dev IBM.2107-75PB501 -array A4 -stgtype fb -extpool P4
mkrank -dev IBM.2107-75PB501 -array A5 -stgtype fb -extpool P5
mkrank -dev IBM.2107-75PB501 -array A6 -stgtype fb -extpool P6
mkrank -dev IBM.2107-75PB501 -array A7 -stgtype fb -extpool P7
mkrank -dev IBM.2107-75PB501 -array A8 -stgtype fb -extpool P8
mkrank -dev IBM.2107-75PB501 -array A9 -stgtype fb -extpool P9
mkrank -dev IBM.2107-75PB501 -array A10 -stgtype fb -extpool P10
mkrank -dev IBM.2107-75PB501 -array A11 -stgtype fb -extpool P11
mkrank -dev IBM.2107-75PB501 -array A12 -stgtype fb -extpool P12
mkrank -dev IBM.2107-75PB501 -array A13 -stgtype fb -extpool P13
mkrank -dev IBM.2107-75PB501 -array A14 -stgtype fb -extpool P14
mkrank -dev IBM.2107-75PB501 -array A15 -stgtype fb -extpool P15
mkrank -dev IBM.2107-75PB501 -array A16 -stgtype fb -extpool P16
mkrank -dev IBM.2107-75PB501 -array A17 -stgtype fb -extpool P17
mkrank -dev IBM.2107-75PB501 -array A18 -stgtype fb -extpool P18
mkrank -dev IBM.2107-75PB501 -array A19 -stgtype fb -extpool P19
mkrank -dev IBM.2107-75PB501 -array A20 -stgtype fb -extpool P20
mkrank -dev IBM.2107-75PB501 -array A21 -stgtype fb -extpool P21
mkrank -dev IBM.2107-75PB501 -array A22 -stgtype fb -extpool P22
mkrank -dev IBM.2107-75PB501 -array A23 -stgtype fb -extpool P23
mkrank -dev IBM.2107-75PB501 -array A24 -stgtype fb -extpool P24
mkrank -dev IBM.2107-75PB501 -array A25 -stgtype fb -extpool P25
```

```
mkrank -dev IBM.2107-75PB501 -array A26 -stgtype fb -extpool P26
mkrank -dev IBM.2107-75PB501 -array A27 -stgtype fb -extpool P27
mkrank -dev IBM.2107-75PB501 -array A28 -stgtype fb -extpool P28
mkrank -dev IBM.2107-75PB501 -array A29 -stgtype fb -extpool P29
mkrank -dev IBM.2107-75PB501 -array A30 -stgtype fb -extpool P30
mkrank -dev IBM.2107-75PB501 -array A31 -stgtype fb -extpool P31
mkrank -dev IBM.2107-75PB501 -array A32 -stgtype fb -extpool P32
mkrank -dev IBM.2107-75PB501 -array A33 -stgtype fb -extpool P33
mkrank -dev IBM.2107-75PB501 -array A34 -stgtype fb -extpool P34
mkrank -dev IBM.2107-75PB501 -array A35 -stgtype fb -extpool P35
mkrank -dev IBM.2107-75PB501 -array A36 -stgtype fb -extpool P36
mkrank -dev IBM.2107-75PB501 -array A37 -stgtype fb -extpool P37
mkrank -dev IBM.2107-75PB501 -array A38 -stgtype fb -extpool P38
mkrank -dev IBM.2107-75PB501 -array A39 -stgtype fb -extpool P39
mkrank -dev IBM.2107-75PB501 -array A40 -stgtype fb -extpool P40
mkrank -dev IBM.2107-75PB501 -array A41 -stgtype fb -extpool P41
mkrank -dev IBM.2107-75PB501 -array A42 -stgtype fb -extpool P42
mkrank -dev IBM.2107-75PB501 -array A43 -stgtype fb -extpool P43
mkrank -dev IBM.2107-75PB501 -array A44 -stgtype fb -extpool P44
mkrank -dev IBM.2107-75PB501 -array A45 -stgtype fb -extpool P45
mkrank -dev IBM.2107-75PB501 -array A46 -stgtype fb -extpool P46
mkrank -dev IBM.2107-75PB501 -array A47 -stgtype fb -extpool P47
mkrank -dev IBM.2107-75PB501 -array A48 -stgtype fb -extpool P48
mkrank -dev IBM.2107-75PB501 -array A49 -stgtype fb -extpool P49
mkrank -dev IBM.2107-75PB501 -array A50 -stgtype fb -extpool P50
mkrank -dev IBM.2107-75PB501 -array A51 -stgtype fb -extpool P51
mkrank -dev IBM.2107-75PB501 -array A52 -stgtype fb -extpool P52
mkrank -dev IBM.2107-75PB501 -array A53 -stgtype fb -extpool P53
mkrank -dev IBM.2107-75PB501 -array A54 -stgtype fb -extpool P54
mkrank -dev IBM.2107-75PB501 -array A55 -stgtype fb -extpool P55
mkrank -dev IBM.2107-75PB501 -array A56 -stgtype fb -extpool P56
mkrank -dev IBM.2107-75PB501 -array A57 -stgtype fb -extpool P57
mkrank -dev IBM.2107-75PB501 -array A58 -stgtype fb -extpool P58
mkrank -dev IBM.2107-75PB501 -array A59 -stgtype fb -extpool P59
mkrank -dev IBM.2107-75PB501 -array A60 -stgtype fb -extpool P60
mkrank -dev IBM.2107-75PB501 -array A61 -stgtype fb -extpool P61
mkrank -dev IBM.2107-75PB501 -array A62 -stgtype fb -extpool P62
mkrank -dev IBM.2107-75PB501 -array A63 -stgtype fb -extpool P63
mkrank -dev IBM.2107-75PB501 -array A64 -stgtype fb -extpool P64
mkrank -dev IBM.2107-75PB501 -array A65 -stgtype fb -extpool P65
mkrank -dev IBM.2107-75PB501 -array A66 -stgtype fb -extpool P66
mkrank -dev IBM.2107-75PB501 -array A67 -stgtype fb -extpool P67
mkrank -dev IBM.2107-75PB501 -array A68 -stgtype fb -extpool P68
mkrank -dev IBM.2107-75PB501 -array A69 -stgtype fb -extpool P69
mkrank -dev IBM.2107-75PB501 -array A70 -stgtype fb -extpool P70
mkrank -dev IBM.2107-75PB501 -array A71 -stgtype fb -extpool P71
mkrank -dev IBM.2107-75PB501 -array A72 -stgtype fb -extpool P72
mkrank -dev IBM.2107-75PB501 -array A73 -stgtype fb -extpool P73
mkrank -dev IBM.2107-75PB501 -array A74 -stgtype fb -extpool P74
mkrank -dev IBM.2107-75PB501 -array A75 -stgtype fb -extpool P75
mkrank -dev IBM.2107-75PB501 -array A76 -stgtype fb -extpool P76
mkrank -dev IBM.2107-75PB501 -array A77 -stgtype fb -extpool P77
mkrank -dev IBM.2107-75PB501 -array A78 -stgtype fb -extpool P78
mkrank -dev IBM.2107-75PB501 -array A79 -stgtype fb -extpool P79
mkrank -dev IBM.2107-75PB501 -array A80 -stgtype fb -extpool P80
mkrank -dev IBM.2107-75PB501 -array A81 -stgtype fb -extpool P81
mkrank -dev IBM.2107-75PB501 -array A82 -stgtype fb -extpool P82
mkrank -dev IBM.2107-75PB501 -array A83 -stgtype fb -extpool P83
mkrank -dev IBM.2107-75PB501 -array A84 -stgtype fb -extpool P84
mkrank -dev IBM.2107-75PB501 -array A85 -stgtype fb -extpool P85
mkrank -dev IBM.2107-75PB501 -array A86 -stgtype fb -extpool P86
mkrank -dev IBM.2107-75PB501 -array A87 -stgtype fb -extpool P87
mkrank -dev IBM.2107-75PB501 -array A88 -stgtype fb -extpool P88
```

```
mkrank -dev IBM.2107-75PB501 -array A89 -stgtype fb -extpool P89
mkrank -dev IBM.2107-75PB501 -array A90 -stgtype fb -extpool P90
mkrank -dev IBM.2107-75PB501 -array A91 -stgtype fb -extpool P91
mkrank -dev IBM.2107-75PB501 -array A92 -stgtype fb -extpool P92
mkrank -dev IBM.2107-75PB501 -array A93 -stgtype fb -extpool P93
mkrank -dev IBM.2107-75PB501 -array A94 -stgtype fb -extpool P94
mkrank -dev IBM.2107-75PB501 -array A95 -stgtype fb -extpool P95
mkrank -dev IBM.2107-75PB501 -array A96 -stgtype fb -extpool P96
mkrank -dev IBM.2107-75PB501 -array A97 -stgtype fb -extpool P97
mkrank -dev IBM.2107-75PB501 -array A98 -stgtype fb -extpool P98
mkrank -dev IBM.2107-75PB501 -array A99 -stgtype fb -extpool P99
mkrank -dev IBM.2107-75PB501 -array A100 -stgtype fb -extpool P100
mkrank -dev IBM.2107-75PB501 -array A101 -stgtype fb -extpool P101
mkrank -dev IBM.2107-75PB501 -array A102 -stgtype fb -extpool P102
mkrank -dev IBM.2107-75PB501 -array A103 -stgtype fb -extpool P103
mkrank -dev IBM.2107-75PB501 -array A104 -stgtype fb -extpool P104
mkrank -dev IBM.2107-75PB501 -array A105 -stgtype fb -extpool P105
mkrank -dev IBM.2107-75PB501 -array A106 -stgtype fb -extpool P106
mkrank -dev IBM.2107-75PB501 -array A107 -stgtype fb -extpool P107
mkrank -dev IBM.2107-75PB501 -array A108 -stgtype fb -extpool P108
mkrank -dev IBM.2107-75PB501 -array A109 -stgtype fb -extpool P109
mkrank -dev IBM.2107-75PB501 -array A110 -stgtype fb -extpool P110
mkrank -dev IBM.2107-75PB501 -array A111 -stgtype fb -extpool P111
mkrank -dev IBM.2107-75PB501 -array A112 -stgtype fb -extpool P112
mkrank -dev IBM.2107-75PB501 -array A113 -stgtype fb -extpool P113
mkrank -dev IBM.2107-75PB501 -array A114 -stgtype fb -extpool P114
mkrank -dev IBM.2107-75PB501 -array A115 -stgtype fb -extpool P115
mkrank -dev IBM.2107-75PB501 -array A116 -stgtype fb -extpool P116
mkrank -dev IBM.2107-75PB501 -array A117 -stgtype fb -extpool P117
mkrank -dev IBM.2107-75PB501 -array A118 -stgtype fb -extpool P118
mkrank -dev IBM.2107-75PB501 -array A119 -stgtype fb -extpool P119
mkrank -dev IBM.2107-75PB501 -array A120 -stgtype fb -extpool P120
mkrank -dev IBM.2107-75PB501 -array A121 -stgtype fb -extpool P121
mkrank -dev IBM.2107-75PB501 -array A122 -stgtype fb -extpool P122
mkrank -dev IBM.2107-75PB501 -array A123 -stgtype fb -extpool P123
mkrank -dev IBM.2107-75PB501 -array A124 -stgtype fb -extpool P124
mkrank -dev IBM.2107-75PB501 -array A125 -stgtype fb -extpool P125
mkrank -dev IBM.2107-75PB501 -array A126 -stgtype fb -extpool P126
mkrank -dev IBM.2107-75PB501 -array A127 -stgtype fb -extpool P127
```

## Create the LUNs

The `step4_makevols.txt` script defines 128 LUNs on the set of 128 RAID-10 ranks.

### step4\_makevols.txt

```
mkfbvol -dev IBM.2107-75PB501 -extpool P0 -type ds -cap 388 0000
mkfbvol -dev IBM.2107-75PB501 -extpool P1 -type ds -cap 519 0100
mkfbvol -dev IBM.2107-75PB501 -extpool P2 -type ds -cap 388 0001
mkfbvol -dev IBM.2107-75PB501 -extpool P3 -type ds -cap 519 0101
mkfbvol -dev IBM.2107-75PB501 -extpool P4 -type ds -cap 519 0002
mkfbvol -dev IBM.2107-75PB501 -extpool P5 -type ds -cap 519 0102
mkfbvol -dev IBM.2107-75PB501 -extpool P6 -type ds -cap 519 0003
mkfbvol -dev IBM.2107-75PB501 -extpool P7 -type ds -cap 519 0103
mkfbvol -dev IBM.2107-75PB501 -extpool P8 -type ds -cap 519 0004
mkfbvol -dev IBM.2107-75PB501 -extpool P9 -type ds -cap 519 0104
mkfbvol -dev IBM.2107-75PB501 -extpool P10 -type ds -cap 519 0005
mkfbvol -dev IBM.2107-75PB501 -extpool P11 -type ds -cap 519 0105
mkfbvol -dev IBM.2107-75PB501 -extpool P12 -type ds -cap 519 0006
mkfbvol -dev IBM.2107-75PB501 -extpool P13 -type ds -cap 519 0106
mkfbvol -dev IBM.2107-75PB501 -extpool P14 -type ds -cap 519 0007
mkfbvol -dev IBM.2107-75PB501 -extpool P15 -type ds -cap 519 0107
```

```
mkfbvol -dev IBM.2107-75PB501 -extpool P16 -type ds -cap 388 0008
mkfbvol -dev IBM.2107-75PB501 -extpool P17 -type ds -cap 519 0108
mkfbvol -dev IBM.2107-75PB501 -extpool P18 -type ds -cap 388 0009
mkfbvol -dev IBM.2107-75PB501 -extpool P19 -type ds -cap 519 0109
mkfbvol -dev IBM.2107-75PB501 -extpool P20 -type ds -cap 519 000A
mkfbvol -dev IBM.2107-75PB501 -extpool P21 -type ds -cap 519 010A
mkfbvol -dev IBM.2107-75PB501 -extpool P22 -type ds -cap 519 000B
mkfbvol -dev IBM.2107-75PB501 -extpool P23 -type ds -cap 519 010B
mkfbvol -dev IBM.2107-75PB501 -extpool P24 -type ds -cap 519 000C
mkfbvol -dev IBM.2107-75PB501 -extpool P25 -type ds -cap 519 010C
mkfbvol -dev IBM.2107-75PB501 -extpool P26 -type ds -cap 519 000D
mkfbvol -dev IBM.2107-75PB501 -extpool P27 -type ds -cap 519 010D
mkfbvol -dev IBM.2107-75PB501 -extpool P28 -type ds -cap 519 000E
mkfbvol -dev IBM.2107-75PB501 -extpool P29 -type ds -cap 519 010E
mkfbvol -dev IBM.2107-75PB501 -extpool P30 -type ds -cap 519 000F
mkfbvol -dev IBM.2107-75PB501 -extpool P31 -type ds -cap 519 010F
mkfbvol -dev IBM.2107-75PB501 -extpool P32 -type ds -cap 388 0010
mkfbvol -dev IBM.2107-75PB501 -extpool P33 -type ds -cap 519 0110
mkfbvol -dev IBM.2107-75PB501 -extpool P34 -type ds -cap 388 0011
mkfbvol -dev IBM.2107-75PB501 -extpool P35 -type ds -cap 519 0111
mkfbvol -dev IBM.2107-75PB501 -extpool P36 -type ds -cap 519 0012
mkfbvol -dev IBM.2107-75PB501 -extpool P37 -type ds -cap 519 0112
mkfbvol -dev IBM.2107-75PB501 -extpool P38 -type ds -cap 519 0013
mkfbvol -dev IBM.2107-75PB501 -extpool P39 -type ds -cap 519 0113
mkfbvol -dev IBM.2107-75PB501 -extpool P40 -type ds -cap 519 0014
mkfbvol -dev IBM.2107-75PB501 -extpool P41 -type ds -cap 519 0114
mkfbvol -dev IBM.2107-75PB501 -extpool P42 -type ds -cap 519 0015
mkfbvol -dev IBM.2107-75PB501 -extpool P43 -type ds -cap 519 0115
mkfbvol -dev IBM.2107-75PB501 -extpool P44 -type ds -cap 519 0016
mkfbvol -dev IBM.2107-75PB501 -extpool P45 -type ds -cap 519 0116
mkfbvol -dev IBM.2107-75PB501 -extpool P46 -type ds -cap 519 0017
mkfbvol -dev IBM.2107-75PB501 -extpool P47 -type ds -cap 519 0117
mkfbvol -dev IBM.2107-75PB501 -extpool P48 -type ds -cap 388 0018
mkfbvol -dev IBM.2107-75PB501 -extpool P49 -type ds -cap 519 0118
mkfbvol -dev IBM.2107-75PB501 -extpool P50 -type ds -cap 388 0019
mkfbvol -dev IBM.2107-75PB501 -extpool P51 -type ds -cap 519 0119
mkfbvol -dev IBM.2107-75PB501 -extpool P52 -type ds -cap 519 001A
mkfbvol -dev IBM.2107-75PB501 -extpool P53 -type ds -cap 519 011A
mkfbvol -dev IBM.2107-75PB501 -extpool P54 -type ds -cap 519 001B
mkfbvol -dev IBM.2107-75PB501 -extpool P55 -type ds -cap 519 011B
mkfbvol -dev IBM.2107-75PB501 -extpool P56 -type ds -cap 519 001C
mkfbvol -dev IBM.2107-75PB501 -extpool P57 -type ds -cap 519 011C
mkfbvol -dev IBM.2107-75PB501 -extpool P58 -type ds -cap 519 001D
mkfbvol -dev IBM.2107-75PB501 -extpool P59 -type ds -cap 519 011D
mkfbvol -dev IBM.2107-75PB501 -extpool P60 -type ds -cap 519 001E
mkfbvol -dev IBM.2107-75PB501 -extpool P61 -type ds -cap 519 011E
mkfbvol -dev IBM.2107-75PB501 -extpool P62 -type ds -cap 519 001F
mkfbvol -dev IBM.2107-75PB501 -extpool P63 -type ds -cap 519 011F
mkfbvol -dev IBM.2107-75PB501 -extpool P64 -type ds -cap 388 0020
mkfbvol -dev IBM.2107-75PB501 -extpool P65 -type ds -cap 519 0120
mkfbvol -dev IBM.2107-75PB501 -extpool P66 -type ds -cap 388 0021
mkfbvol -dev IBM.2107-75PB501 -extpool P67 -type ds -cap 519 0121
mkfbvol -dev IBM.2107-75PB501 -extpool P68 -type ds -cap 519 0022
mkfbvol -dev IBM.2107-75PB501 -extpool P69 -type ds -cap 519 0122
mkfbvol -dev IBM.2107-75PB501 -extpool P70 -type ds -cap 519 0023
mkfbvol -dev IBM.2107-75PB501 -extpool P71 -type ds -cap 519 0123
mkfbvol -dev IBM.2107-75PB501 -extpool P72 -type ds -cap 519 0024
mkfbvol -dev IBM.2107-75PB501 -extpool P73 -type ds -cap 519 0124
mkfbvol -dev IBM.2107-75PB501 -extpool P74 -type ds -cap 519 0025
mkfbvol -dev IBM.2107-75PB501 -extpool P75 -type ds -cap 519 0125
mkfbvol -dev IBM.2107-75PB501 -extpool P76 -type ds -cap 519 0026
mkfbvol -dev IBM.2107-75PB501 -extpool P77 -type ds -cap 519 0126
mkfbvol -dev IBM.2107-75PB501 -extpool P78 -type ds -cap 519 0027
```

```
mkfbvol -dev IBM.2107-75PB501 -extpool P79 -type ds -cap 519 0127
mkfbvol -dev IBM.2107-75PB501 -extpool P80 -type ds -cap 388 0028
mkfbvol -dev IBM.2107-75PB501 -extpool P81 -type ds -cap 519 0128
mkfbvol -dev IBM.2107-75PB501 -extpool P82 -type ds -cap 388 0029
mkfbvol -dev IBM.2107-75PB501 -extpool P83 -type ds -cap 519 0129
mkfbvol -dev IBM.2107-75PB501 -extpool P84 -type ds -cap 519 002A
mkfbvol -dev IBM.2107-75PB501 -extpool P85 -type ds -cap 519 012A
mkfbvol -dev IBM.2107-75PB501 -extpool P86 -type ds -cap 519 002B
mkfbvol -dev IBM.2107-75PB501 -extpool P87 -type ds -cap 519 012B
mkfbvol -dev IBM.2107-75PB501 -extpool P88 -type ds -cap 519 002C
mkfbvol -dev IBM.2107-75PB501 -extpool P89 -type ds -cap 519 012C
mkfbvol -dev IBM.2107-75PB501 -extpool P90 -type ds -cap 519 002D
mkfbvol -dev IBM.2107-75PB501 -extpool P91 -type ds -cap 519 012D
mkfbvol -dev IBM.2107-75PB501 -extpool P92 -type ds -cap 519 002E
mkfbvol -dev IBM.2107-75PB501 -extpool P93 -type ds -cap 519 012E
mkfbvol -dev IBM.2107-75PB501 -extpool P94 -type ds -cap 519 002F
mkfbvol -dev IBM.2107-75PB501 -extpool P95 -type ds -cap 519 012F
mkfbvol -dev IBM.2107-75PB501 -extpool P96 -type ds -cap 388 0030
mkfbvol -dev IBM.2107-75PB501 -extpool P97 -type ds -cap 519 0130
mkfbvol -dev IBM.2107-75PB501 -extpool P98 -type ds -cap 388 0031
mkfbvol -dev IBM.2107-75PB501 -extpool P99 -type ds -cap 519 0131
mkfbvol -dev IBM.2107-75PB501 -extpool P100 -type ds -cap 519 0032
mkfbvol -dev IBM.2107-75PB501 -extpool P101 -type ds -cap 519 0132
mkfbvol -dev IBM.2107-75PB501 -extpool P102 -type ds -cap 519 0033
mkfbvol -dev IBM.2107-75PB501 -extpool P103 -type ds -cap 519 0133
mkfbvol -dev IBM.2107-75PB501 -extpool P104 -type ds -cap 519 0034
mkfbvol -dev IBM.2107-75PB501 -extpool P105 -type ds -cap 519 0134
mkfbvol -dev IBM.2107-75PB501 -extpool P106 -type ds -cap 519 0035
mkfbvol -dev IBM.2107-75PB501 -extpool P107 -type ds -cap 519 0135
mkfbvol -dev IBM.2107-75PB501 -extpool P108 -type ds -cap 519 0036
mkfbvol -dev IBM.2107-75PB501 -extpool P109 -type ds -cap 519 0136
mkfbvol -dev IBM.2107-75PB501 -extpool P110 -type ds -cap 519 0037
mkfbvol -dev IBM.2107-75PB501 -extpool P111 -type ds -cap 519 0137
mkfbvol -dev IBM.2107-75PB501 -extpool P112 -type ds -cap 388 0038
mkfbvol -dev IBM.2107-75PB501 -extpool P113 -type ds -cap 519 0138
mkfbvol -dev IBM.2107-75PB501 -extpool P114 -type ds -cap 388 0039
mkfbvol -dev IBM.2107-75PB501 -extpool P115 -type ds -cap 519 0139
mkfbvol -dev IBM.2107-75PB501 -extpool P116 -type ds -cap 519 003A
mkfbvol -dev IBM.2107-75PB501 -extpool P117 -type ds -cap 519 013A
mkfbvol -dev IBM.2107-75PB501 -extpool P118 -type ds -cap 519 003B
mkfbvol -dev IBM.2107-75PB501 -extpool P119 -type ds -cap 519 013B
mkfbvol -dev IBM.2107-75PB501 -extpool P120 -type ds -cap 519 003C
mkfbvol -dev IBM.2107-75PB501 -extpool P121 -type ds -cap 519 013C
mkfbvol -dev IBM.2107-75PB501 -extpool P122 -type ds -cap 519 003D
mkfbvol -dev IBM.2107-75PB501 -extpool P123 -type ds -cap 519 013D
mkfbvol -dev IBM.2107-75PB501 -extpool P124 -type ds -cap 519 003E
mkfbvol -dev IBM.2107-75PB501 -extpool P125 -type ds -cap 519 013E
mkfbvol -dev IBM.2107-75PB501 -extpool P126 -type ds -cap 519 003F
mkfbvol -dev IBM.2107-75PB501 -extpool P127 -type ds -cap 519 013F
```

The **step5\_volgroups.txt** script assigns each volume to one of two volume groups, V0 or V1, so that paths can be assigned by groups of volumes. The LUNs assigned to V0 belong to even numbered extent pools (P0, P2, P4, ...); the LUNs assigned to V1 belong to odd numbered extent pools (P1, P3, P5, ...)

#### step5\_volgroups.txt

```
mkvolgrp -dev IBM.2107-7503471 -hosttype pSeries ss10_volgrp0
mkvolgrp -dev IBM.2107-7503471 -hosttype pSeries ss10_volgrp1

chvolgrp -dev IBM.2107-75PB501 -name ss10_volgrp0 -action add -volume 0000 V0
chvolgrp -dev IBM.2107-75PB501 -name ss10_volgrp0 -action add -volume 0001 V0
```







## Define presentation of the LUNs

The **step6\_ports.txt** script sets the IO port topology to scsi-fcp for all ports that are being used, which is required for attachment to SVC via a switch.

### step6\_ports.txt

```
setioport -dev IBM.2107-75PB501 -topology scsi-fcp I0010 I0040 I0100 I0130 I0210  
I0240 I0300 I0330 I0410 I0440 I0500 I0530 I0610 I0640 I0700 I0730
```

The **step7\_presenteven.txt** script defines the required mappings so that volumes on even numbered extent pools can be seen by SVC. Execution of this script was followed by a short delay during which the LUNs were discovered on the SVC.

### step7\_presenteven.txt

```
mkhostconnect -dev IBM.2107-75PB501 -wwname 500507680140a019 -profile "San Volume  
Controller" -volgrp V0 -ioport I0010,I0040,I0210,I0240,I0410,I0440,I0610,I0640  
V0_n1_pA  
mkhostconnect -dev IBM.2107-75PB501 -wwname 500507680140a00c -profile "San Volume  
Controller" -volgrp V0 -ioport I0010,I0040,I0210,I0240,I0410,I0440,I0610,I0640  
V0_n3_pA  
mkhostconnect -dev IBM.2107-75PB501 -wwname 500507680140a00d -profile "San Volume  
Controller" -volgrp V0 -ioport I0010,I0040,I0210,I0240,I0410,I0440,I0610,I0640  
V0_n5_pA  
mkhostconnect -dev IBM.2107-75PB501 -wwname 5005076801400009 -profile "San Volume  
Controller" -volgrp V0 -ioport I0010,I0040,I0210,I0240,I0410,I0440,I0610,I0640  
V0_n2_pA  
mkhostconnect -dev IBM.2107-75PB501 -wwname 500507680140a012 -profile "San Volume  
Controller" -volgrp V0 -ioport I0010,I0040,I0210,I0240,I0410,I0440,I0610,I0640  
V0_n4_pA  
mkhostconnect -dev IBM.2107-75PB501 -wwname 500507680140a004 -profile "San Volume  
Controller" -volgrp V0 -ioport I0010,I0040,I0210,I0240,I0410,I0440,I0610,I0640  
V0_n6_pA  
mkhostconnect -dev IBM.2107-75PB501 -wwname 500507680130a019 -profile "San Volume  
Controller" -volgrp V0 -ioport I0010,I0040,I0210,I0240,I0410,I0440,I0610,I0640  
V0_n1_pB  
mkhostconnect -dev IBM.2107-75PB501 -wwname 500507680130a00c -profile "San Volume  
Controller" -volgrp V0 -ioport I0010,I0040,I0210,I0240,I0410,I0440,I0610,I0640  
V0_n3_pB  
mkhostconnect -dev IBM.2107-75PB501 -wwname 500507680130a00d -profile "San Volume  
Controller" -volgrp V0 -ioport I0010,I0040,I0210,I0240,I0410,I0440,I0610,I0640  
V0_n5_pB  
mkhostconnect -dev IBM.2107-75PB501 -wwname 5005076801300009 -profile "San Volume  
Controller" -volgrp V0 -ioport I0010,I0040,I0210,I0240,I0410,I0440,I0610,I0640  
V0_n2_pB  
mkhostconnect -dev IBM.2107-75PB501 -wwname 500507680130a012 -profile "San Volume  
Controller" -volgrp V0 -ioport I0010,I0040,I0210,I0240,I0410,I0440,I0610,I0640  
V0_n4_pB  
mkhostconnect -dev IBM.2107-75PB501 -wwname 500507680130a004 -profile "San Volume  
Controller" -volgrp V0 -ioport I0010,I0040,I0210,I0240,I0410,I0440,I0610,I0640  
V0_n6_pB  
mkhostconnect -dev IBM.2107-75PB501 -wwname 500507680110a019 -profile "San Volume  
Controller" -volgrp V0 -ioport I0010,I0040,I0210,I0240,I0410,I0440,I0610,I0640  
V0_n1_pC  
mkhostconnect -dev IBM.2107-75PB501 -wwname 500507680110a00c -profile "San Volume  
Controller" -volgrp V0 -ioport I0010,I0040,I0210,I0240,I0410,I0440,I0610,I0640  
V0_n3_pC  
mkhostconnect -dev IBM.2107-75PB501 -wwname 500507680110a00d -profile "San Volume  
Controller" -volgrp V0 -ioport I0010,I0040,I0210,I0240,I0410,I0440,I0610,I0640  
V0_n5_pC
```

```
mkhostconnect -dev IBM.2107-75PB501 -wwname 5005076801100009 -profile "San Volume  
Controller" -volgrp V0 -ioport I0010,I0040,I0210,I0240,I0410,I0440,I0610,I0640  
V0_n2_pC  
mkhostconnect -dev IBM.2107-75PB501 -wwname 500507680110a012 -profile "San Volume  
Controller" -volgrp V0 -ioport I0010,I0040,I0210,I0240,I0410,I0440,I0610,I0640  
V0_n4_pC  
mkhostconnect -dev IBM.2107-75PB501 -wwname 500507680110a004 -profile "San Volume  
Controller" -volgrp V0 -ioport I0010,I0040,I0210,I0240,I0410,I0440,I0610,I0640  
V0_n6_pC  
mkhostconnect -dev IBM.2107-75PB501 -wwname 500507680120a019 -profile "San Volume  
Controller" -volgrp V0 -ioport I0010,I0040,I0210,I0240,I0410,I0440,I0610,I0640  
V0_n1_pD  
mkhostconnect -dev IBM.2107-75PB501 -wwname 500507680120a00c -profile "San Volume  
Controller" -volgrp V0 -ioport I0010,I0040,I0210,I0240,I0410,I0440,I0610,I0640  
V0_n3_pD  
mkhostconnect -dev IBM.2107-75PB501 -wwname 500507680120a00d -profile "San Volume  
Controller" -volgrp V0 -ioport I0010,I0040,I0210,I0240,I0410,I0440,I0610,I0640  
V0_n5_pD  
mkhostconnect -dev IBM.2107-75PB501 -wwname 5005076801200009 -profile "San Volume  
Controller" -volgrp V0 -ioport I0010,I0040,I0210,I0240,I0410,I0440,I0610,I0640  
V0_n2_pD  
mkhostconnect -dev IBM.2107-75PB501 -wwname 500507680120a012 -profile "San Volume  
Controller" -volgrp V0 -ioport I0010,I0040,I0210,I0240,I0410,I0440,I0610,I0640  
V0_n4_pD  
mkhostconnect -dev IBM.2107-75PB501 -wwname 500507680120a004 -profile "San Volume  
Controller" -volgrp V0 -ioport I0010,I0040,I0210,I0240,I0410,I0440,I0610,I0640  
V0_n6_pD
```

The **step8\_presentodd.txt** script defines the required mappings so that volumes on odd numbered extent pools can be seen by SVC. Execution of this script was followed by a short delay during which the LUNs were discovered on the SVC.

#### **step8\_presentodd.txt**

```
mkhostconnect -dev IBM.2107-75PB501 -wwname 500507680140a019 -profile "San Volume  
Controller" -volgrp V1 -ioport I0100,I0130,I0300,I0330,I0500,I0530,I0700,I0730  
V1_n1_pA  
mkhostconnect -dev IBM.2107-75PB501 -wwname 500507680140a00c -profile "San Volume  
Controller" -volgrp V1 -ioport I0100,I0130,I0300,I0330,I0500,I0530,I0700,I0730  
V1_n3_pA  
mkhostconnect -dev IBM.2107-75PB501 -wwname 500507680140a00d -profile "San Volume  
Controller" -volgrp V1 -ioport I0100,I0130,I0300,I0330,I0500,I0530,I0700,I0730  
V1_n5_pA  
mkhostconnect -dev IBM.2107-75PB501 -wwname 5005076801400009 -profile "San Volume  
Controller" -volgrp V1 -ioport I0100,I0130,I0300,I0330,I0500,I0530,I0700,I0730  
V1_n2_pA  
mkhostconnect -dev IBM.2107-75PB501 -wwname 500507680140a012 -profile "San Volume  
Controller" -volgrp V1 -ioport I0100,I0130,I0300,I0330,I0500,I0530,I0700,I0730  
V1_n4_pA  
mkhostconnect -dev IBM.2107-75PB501 -wwname 500507680140a004 -profile "San Volume  
Controller" -volgrp V1 -ioport I0100,I0130,I0300,I0330,I0500,I0530,I0700,I0730  
V1_n6_pA  
mkhostconnect -dev IBM.2107-75PB501 -wwname 500507680130a019 -profile "San Volume  
Controller" -volgrp V1 -ioport I0100,I0130,I0300,I0330,I0500,I0530,I0700,I0730  
V1_n1_pB  
mkhostconnect -dev IBM.2107-75PB501 -wwname 500507680130a00c -profile "San Volume  
Controller" -volgrp V1 -ioport I0100,I0130,I0300,I0330,I0500,I0530,I0700,I0730  
V1_n3_pB  
mkhostconnect -dev IBM.2107-75PB501 -wwname 500507680130a00d -profile "San Volume  
Controller" -volgrp V1 -ioport I0100,I0130,I0300,I0330,I0500,I0530,I0700,I0730  
V1_n5_pB
```

```
mkhostconnect -dev IBM.2107-75PB501 -wwname 5005076801300009 -profile "San Volume  
Controller" -volgrp V1 -ioport I0100,I0130,I0300,I0330,I0500,I0530,I0700,I0730  
V1_n2_pB  
mkhostconnect -dev IBM.2107-75PB501 -wwname 500507680130a012 -profile "San Volume  
Controller" -volgrp V1 -ioport I0100,I0130,I0300,I0330,I0500,I0530,I0700,I0730  
V1_n4_pB  
mkhostconnect -dev IBM.2107-75PB501 -wwname 500507680130a004 -profile "San Volume  
Controller" -volgrp V1 -ioport I0100,I0130,I0300,I0330,I0500,I0530,I0700,I0730  
V1_n6_pB  
mkhostconnect -dev IBM.2107-75PB501 -wwname 500507680110a019 -profile "San Volume  
Controller" -volgrp V1 -ioport I0100,I0130,I0300,I0330,I0500,I0530,I0700,I0730  
V1_n1_pC  
mkhostconnect -dev IBM.2107-75PB501 -wwname 500507680110a00c -profile "San Volume  
Controller" -volgrp V1 -ioport I0100,I0130,I0300,I0330,I0500,I0530,I0700,I0730  
V1_n3_pC  
mkhostconnect -dev IBM.2107-75PB501 -wwname 500507680110a00d -profile "San Volume  
Controller" -volgrp V1 -ioport I0100,I0130,I0300,I0330,I0500,I0530,I0700,I0730  
V1_n5_pC  
mkhostconnect -dev IBM.2107-75PB501 -wwname 5005076801100009 -profile "San Volume  
Controller" -volgrp V1 -ioport I0100,I0130,I0300,I0330,I0500,I0530,I0700,I0730  
V1_n2_pC  
mkhostconnect -dev IBM.2107-75PB501 -wwname 500507680110a012 -profile "San Volume  
Controller" -volgrp V1 -ioport I0100,I0130,I0300,I0330,I0500,I0530,I0700,I0730  
V1_n4_pC  
mkhostconnect -dev IBM.2107-75PB501 -wwname 500507680110a004 -profile "San Volume  
Controller" -volgrp V1 -ioport I0100,I0130,I0300,I0330,I0500,I0530,I0700,I0730  
V1_n6_pC  
mkhostconnect -dev IBM.2107-75PB501 -wwname 500507680120a019 -profile "San Volume  
Controller" -volgrp V1 -ioport I0100,I0130,I0300,I0330,I0500,I0530,I0700,I0730  
V1_n1_pD  
mkhostconnect -dev IBM.2107-75PB501 -wwname 500507680120a00c -profile "San Volume  
Controller" -volgrp V1 -ioport I0100,I0130,I0300,I0330,I0500,I0530,I0700,I0730  
V1_n3_pD  
mkhostconnect -dev IBM.2107-75PB501 -wwname 500507680120a00d -profile "San Volume  
Controller" -volgrp V1 -ioport I0100,I0130,I0300,I0330,I0500,I0530,I0700,I0730  
V1_n5_pD  
mkhostconnect -dev IBM.2107-75PB501 -wwname 5005076801200009 -profile "San Volume  
Controller" -volgrp V1 -ioport I0100,I0130,I0300,I0330,I0500,I0530,I0700,I0730  
V1_n2_pD  
mkhostconnect -dev IBM.2107-75PB501 -wwname 500507680120a012 -profile "San Volume  
Controller" -volgrp V1 -ioport I0100,I0130,I0300,I0330,I0500,I0530,I0700,I0730  
V1_n4_pD  
mkhostconnect -dev IBM.2107-75PB501 -wwname 500507680120a004 -profile "San Volume  
Controller" -volgrp V1 -ioport I0100,I0130,I0300,I0330,I0500,I0530,I0700,I0730  
V1_n6_pD
```

## Configure the second DS8700

The above steps to configure the first DS8700 (*IBM2107-75PB501*) must be repeated to configure the second DS8700 (*IBM2107-75PF901*) in the TSC.

## SVC Configuration Steps

The SVC configuration steps are carried out on the SVC Master Console. The widely available software PUTTY is used to communicate with the SVC. In the steps that follow, the address "perfclus\_local" is defined in PUTTY so as to correspond to the IP of the SVC cluster.

## Discover SVC MDisks

During the short delays just mentioned in steps 7 and 8, issue the command “`plink perfclus_local svctask detectmdisk`”. This ensures that SVC discovers the various DS8700 LUN’s when they are presented (such discovery will also occur automatically over a brief period of time).

After all DS8700 LUN’s have been detected as MDisks (total of 256 LUN’s), execute the script `mk2groups.bsh`. This script defines two MDisk groups (`biggroup1` and `biggroup2`) which will be used to contain the MDisks.

### mk2groups.bsh

```
#!/usr/bin/bash
#run in cygwin command line
mlist1=`plink perfclus_local svcinfo lsmdisk -nohdr | awk -v ORS="" '{ print ((FNR==1)|| (FNR>128)?":":") (FNR<129?$2:"") }'`
mlist2=`plink perfclus_local svcinfo lsmdisk -nohdr | awk -v ORS="" '{ print ((FNR<130)?":":") (FNR>128?$2:"") }'`

plink perfclus_local svctask mkmdiskgrp -name biggroup1 -ext 256 -mdisk $mlist1
plink perfclus_local svctask mkmdiskgrp -name biggroup2 -ext 256 -mdisk $mlist2
```

## Define SVC VDisks

In this configuration, a one to one mapping is defined in which each MDisk corresponds to a VDisk as presented to the AIX host. This is done so as to permit striping to be performed by the AIX Logical Volume Manager. To define the set of 256 VDisks that correspond to the 256 MDisks, execute the script `mk256vd_6node_seq.bsh`.

### mk256vd\_6node\_seq.bsh

```
#!/usr/bin/bash
#execute in cygwin command line
i=0
while [[ $i -le 255 ]]
do
    let lode="1 + ((i%24) / 4)"
    let iogrp="((i%24) / 8)"
    let j="(i%4)*64 + (i/4)"
    if [[ $j -ge 128 ]]
    then
        mdgrp=2
    else
        mdgrp=1
    fi
    cap=`plink perfclus_local svcinfo lsmdisk md$j | grep capacity | awk -F"[.]" '{print $2}'`
    let cap="cap-1"
    plink perfclus_local svctask mkvdisk -vtype seq -mdisk md$j \
        -size $cap -unit gb -mdiskgrp biggroup$mdgrp -iogrp io_grp$iogrp \
        -name vd$i -node lode$lode
    let i="i+1"
done
```

To define the 32 host ports used in order to permit access to the VDisks, execute the script `mkhosts.bat`.

### mkhosts.bat

```
plink perfclus_local svctask mkhost -force -name fcs0 -hbawwpn 10000000C944431B
plink perfclus_local svctask mkhost -force -name fcs1 -hbawwpn 10000000C9424FD5
plink perfclus_local svctask mkhost -force -name fcs2 -hbawwpn 10000000C94259CC
plink perfclus_local svctask mkhost -force -name fcs3 -hbawwpn 10000000C942518A
plink perfclus_local svctask mkhost -force -name fcs4 -hbawwpn 10000000C94030FD
plink perfclus_local svctask mkhost -force -name fcs5 -hbawwpn 10000000C942498B
plink perfclus_local svctask mkhost -force -name fcs6 -hbawwpn 10000000C94256F7
plink perfclus_local svctask mkhost -force -name fcs7 -hbawwpn 10000000C9427F7E
plink perfclus_local svctask mkhost -force -name fcs8 -hbawwpn 10000000C9444479
plink perfclus_local svctask mkhost -force -name fcs9 -hbawwpn 10000000C944446C
plink perfclus_local svctask mkhost -force -name fcs10 -hbawwpn 10000000C94443C8
plink perfclus_local svctask mkhost -force -name fcs11 -hbawwpn 10000000C9444524
plink perfclus_local svctask mkhost -force -name fcs12 -hbawwpn 10000000C94440F4
plink perfclus_local svctask mkhost -force -name fcs13 -hbawwpn 10000000C9403183
plink perfclus_local svctask mkhost -force -name fcs14 -hbawwpn 10000000C9427A39
plink perfclus_local svctask mkhost -force -name fcs15 -hbawwpn 10000000C942E674
plink perfclus_local svctask mkhost -force -name fcs16 -hbawwpn 10000000C944454D
plink perfclus_local svctask mkhost -force -name fcs17 -hbawwpn 10000000C94079D7
plink perfclus_local svctask mkhost -force -name fcs18 -hbawwpn 10000000C94443C9
plink perfclus_local svctask mkhost -force -name fcs19 -hbawwpn 10000000C9427DB5
plink perfclus_local svctask mkhost -force -name fcs20 -hbawwpn 10000000C94443C0
plink perfclus_local svctask mkhost -force -name fcs21 -hbawwpn 10000000C9444199
plink perfclus_local svctask mkhost -force -name fcs22 -hbawwpn 10000000C944425F
plink perfclus_local svctask mkhost -force -name fcs23 -hbawwpn 10000000C94443DA
plink perfclus_local svctask mkhost -force -name fcs24 -hbawwpn 10000000C94441ED
plink perfclus_local svctask mkhost -force -name fcs25 -hbawwpn 10000000C9444428
plink perfclus_local svctask mkhost -force -name fcs26 -hbawwpn 10000000C9427F7F
plink perfclus_local svctask mkhost -force -name fcs27 -hbawwpn 10000000C944428C
plink perfclus_local svctask mkhost -force -name fcs28 -hbawwpn 10000000C9444204
plink perfclus_local svctask mkhost -force -name fcs29 -hbawwpn 10000000C9402F88
plink perfclus_local svctask mkhost -force -name fcs30 -hbawwpn 10000000C9444156
plink perfclus_local svctask mkhost -force -name fcs31 -hbawwpn 10000000C9444311
```

To present each Vdisk to the AIX host on a pair of host paths, execute the script **mapfcs256to32\_perfsh2d.bsh**.

**mapfcs256to32\_perfsh2d.bsh**

```
#!/usr/bin/bash
# run in cygwin command line
# Maps each vdisk to two fcs's.

# The fcs's are organized
# into groups of four, with two groups in each switch.
fcsarray=( \
  4 14 11 22      23 13 31  5  \
  15 27  2 20      16 10 30  7  \
  24 26  6 29      9  0 19 12  \
  25 17  1  3      21 18  8 28 )

i=0
while [[ $i -le 31 ]]
do
  let k="i - ((i/4)%2)*4" #odd and even nodes are handled symmetrically except for
  offset of 4
  let j="(k%4)*8 + k/8 + ((i/4)%2)*4"
  $plink svctask mkvdiskhostmap -force -host fcs${fcsarray[j]} vd$i
  let aj="(k%4)*8 + k/8 + (1-(i/4)%2)*4 +8-16*((j%16)/8)"
  $plink svctask mkvdiskhostmap -force -host fcs${fcsarray[aj]} vd$i
  repeat=1
  while [[ $repeat -le 7 ]]
  do
    let ii="i+32*repeat"
```

```
$plink svctask mkvdiskhostmap -force -host fcs${fcsarray[j]} vd$ii
$plink svctask mkvdiskhostmap -force -host fcs${fcsarray[aj]} vd$ii
let repeat="repeat+1"
done
let i="i+1"
done
```

## AIX Configuration Steps

The final portion of constructing the configuration was performed on the AIX host.

To discover the set of 256 hdisks that represent the AIX view of the VDisks, execute the command "cfgmgr". On the host system of the test, this resulted in discovering hdisk50, hdisk51, ..., hdisk305.

To change the queue depth of the 256 hdisks, the following commands were executed:

```
h=50
while [[ $h -le 305 ]]
do
chdev -l hdisk$h -a queue_depth=80
done
```

To define a striped logical volume group containing the 256 hdisks, and to make available the logical volumes used for ASU storage, the following script was invoked: **mapthem.sh 10912 64 8286 4 6190 3**

### mapthem.sh 10912 64 8286 4 6190 3

```
# makes striped volume group from two hdisk sizes using map; makes vols with a
specified number of specified meg partitions.
# important: assumes MPIO, assumes specified map rotation divides LV partitions.
if [[ ($# -lt 6) ]]
then
echo "Usage: mapthem LV partitions psize \n\
Large hdisk total & 1 pass partitions \n\
Small hdisk total & 1 pass partitions \n\
LV partitions must be divisible by total partitions in a pass (not checked)"
return
fi
partspervol=$1
psize=$2

hfield=$(lsdev -Cc disk | grep 'SAN Volume' | awk '{print $1}')
mkvg -fy mapstripevg -S -P 2048 -U 2048 -s $psize $hfield

hnum=`echo $hfield | wc -w`
parts=`lsvg mapstripevg | grep "FREE PPs:" | awk '{print $6}'`
#let numlv="parts / partspervol"
let numlv=142 #only this fixed number are needed
let usedparts="partspervol * numlv"
print "creating $numlv logical volumes"
print "these will use $usedparts out of $parts available partitions"

maplate1=`lsvg -p mapstripevg | awk '{print $1 " " $4}' | grep " $3" | awk '{print $1 " :"}'`
maplate2=`lsvg -p mapstripevg | awk '{print $1 " " $4}' | grep " $5" | awk '{print $1 " :"}'`
```

```
hnum1=`echo $maplate1 | wc -w`
hnum2=`echo $maplate2 | wc -w`
let passsize="$4*hnum1 + $6*hnum2"
let lvpas="$1/passsize"

i=1
j=1
l=1
while [[ $l -le $numlv ]]
do
let mapend="l*$4*lvpas"
echo "" > mapstripevg.map
while [[ $i -le $mapend ]]
do
echo "$maplate1" | sed "s/://:$i/g" >> mapstripevg.map
let k="(i-1)%$4+1"
if [[ $k -le $6 ]]
then
echo "$maplate2" | sed "s/://:$j/g" >> mapstripevg.map
let j="j+1"
fi
let i="i+1"
done

mklv -b n -y map$l -x 32512 -m mapstripevg.map mapstripevg $partspervol
let l="l+1"
done
```

**This script creates 142 logical volumes, each having 10912 partitions, with a partition size of 64 MiB. Striping is performed across hdisks of two sizes (8286 and 6190 partitions). For each 4 partitions taken from an hdisk of the larger size, there are 3 taken from an hdisk of the smaller size.**

**The resulting 142 volumes were then provided as ASU storage.**

## **APPENDIX D: SPC-1 WORKLOAD GENERATOR STORAGE COMMANDS AND PARAMETERS**

The content of SPC-1 Workload Generator command and parameter files, used in this benchmark to execute the Primary Metrics and Repeatability Tests, is listed below.

### **Primary Metrics Test**

#### **Sustainability**

```
host=master
slaves=(slave1,slave2,slave3,slave4,slave5,slave6,slave7,slave8,slave9,slave10,slave
11,slave12,slave13,slave14,slave15,slave16,slave17,slave18,slave19,slave20,slave21,s
lave22,slave23,slave24,slave25,slave26,slave27,slave28,slave29,slave30,slave31,slave
32,slave33,slave34,slave35,slave36,slave37,slave38,slave39,slave40,slave41,slave42,s
lave43,slave44,slave45,slave46,slave47,slave48,slave49,slave50,slave51,slave52,slave
53,slave54,slave55,slave56,slave57,slave58,slave59,slave60,slave61,slave62,slave63,s
lave64,slave65,slave66,slave67,slave68,slave69,slave70,slave71,slave72,slave73,slave
74,slave75,slave76,slave77,slave78,slave79,slave80,slave81)

javaparms="-Xms1280m -Xmx1280m -Xss96k -Xgcpolicy:optavgpause"
sd=default,size=687194767360
#sd=default,size=343597383680
sd=asul_1,lun=/dev/rmap1
sd=asul_2,lun=/dev/rmap2
sd=asul_3,lun=/dev/rmap3
sd=asul_4,lun=/dev/rmap4
sd=asul_5,lun=/dev/rmap5
sd=asul_6,lun=/dev/rmap6
sd=asul_7,lun=/dev/rmap7
sd=asul_8,lun=/dev/rmap8
sd=asul_9,lun=/dev/rmap9
sd=asul_10,lun=/dev/rmap10
sd=asul_11,lun=/dev/rmap11
sd=asul_12,lun=/dev/rmap12
sd=asul_13,lun=/dev/rmap13
sd=asul_14,lun=/dev/rmap14
sd=asul_15,lun=/dev/rmap15
sd=asul_16,lun=/dev/rmap16
sd=asul_17,lun=/dev/rmap17
sd=asul_18,lun=/dev/rmap18
sd=asul_19,lun=/dev/rmap19
sd=asul_20,lun=/dev/rmap20
sd=asul_21,lun=/dev/rmap21
sd=asul_22,lun=/dev/rmap22
sd=asul_23,lun=/dev/rmap23
sd=asul_24,lun=/dev/rmap24
sd=asul_25,lun=/dev/rmap25
sd=asul_26,lun=/dev/rmap26
sd=asul_27,lun=/dev/rmap27
sd=asul_28,lun=/dev/rmap28
sd=asul_29,lun=/dev/rmap29
sd=asul_30,lun=/dev/rmap30
sd=asul_31,lun=/dev/rmap31
sd=asul_32,lun=/dev/rmap32
sd=asul_33,lun=/dev/rmap33
sd=asul_34,lun=/dev/rmap34
sd=asul_35,lun=/dev/rmap35
sd=asul_36,lun=/dev/rmap36
sd=asul_37,lun=/dev/rmap37
```



sd=asu1\_38,lun=/dev/rmap38  
sd=asu1\_39,lun=/dev/rmap39  
sd=asu1\_40,lun=/dev/rmap40  
sd=asu1\_41,lun=/dev/rmap41  
sd=asu1\_42,lun=/dev/rmap42  
sd=asu1\_43,lun=/dev/rmap43  
sd=asu1\_44,lun=/dev/rmap44  
sd=asu1\_45,lun=/dev/rmap45  
sd=asu1\_46,lun=/dev/rmap46  
sd=asu1\_47,lun=/dev/rmap47  
sd=asu1\_48,lun=/dev/rmap48  
sd=asu1\_49,lun=/dev/rmap49  
sd=asu1\_50,lun=/dev/rmap50  
sd=asu1\_51,lun=/dev/rmap51  
sd=asu1\_52,lun=/dev/rmap52  
sd=asu1\_53,lun=/dev/rmap53  
sd=asu1\_54,lun=/dev/rmap54  
sd=asu1\_55,lun=/dev/rmap55  
sd=asu1\_56,lun=/dev/rmap56  
sd=asu1\_57,lun=/dev/rmap57  
sd=asu1\_58,lun=/dev/rmap58  
sd=asu1\_59,lun=/dev/rmap59  
sd=asu1\_60,lun=/dev/rmap60  
sd=asu1\_61,lun=/dev/rmap61  
sd=asu1\_62,lun=/dev/rmap62  
sd=asu1\_63,lun=/dev/rmap63  
sd=asu1\_64,lun=/dev/rmap64  
sd=asu2\_1,lun=/dev/rmap65  
sd=asu2\_2,lun=/dev/rmap66  
sd=asu2\_3,lun=/dev/rmap67  
sd=asu2\_4,lun=/dev/rmap68  
sd=asu2\_5,lun=/dev/rmap69  
sd=asu2\_6,lun=/dev/rmap70  
sd=asu2\_7,lun=/dev/rmap71  
sd=asu2\_8,lun=/dev/rmap72  
sd=asu2\_9,lun=/dev/rmap73  
sd=asu2\_10,lun=/dev/rmap74  
sd=asu2\_11,lun=/dev/rmap75  
sd=asu2\_12,lun=/dev/rmap76  
sd=asu2\_13,lun=/dev/rmap77  
sd=asu2\_14,lun=/dev/rmap78  
sd=asu2\_15,lun=/dev/rmap79  
sd=asu2\_16,lun=/dev/rmap80  
sd=asu2\_17,lun=/dev/rmap81  
sd=asu2\_18,lun=/dev/rmap82  
sd=asu2\_19,lun=/dev/rmap83  
sd=asu2\_20,lun=/dev/rmap84  
sd=asu2\_21,lun=/dev/rmap85  
sd=asu2\_22,lun=/dev/rmap86  
sd=asu2\_23,lun=/dev/rmap87  
sd=asu2\_24,lun=/dev/rmap88  
sd=asu2\_25,lun=/dev/rmap89  
sd=asu2\_26,lun=/dev/rmap90  
sd=asu2\_27,lun=/dev/rmap91  
sd=asu2\_28,lun=/dev/rmap92  
sd=asu2\_29,lun=/dev/rmap93  
sd=asu2\_30,lun=/dev/rmap94  
sd=asu2\_31,lun=/dev/rmap95  
sd=asu2\_32,lun=/dev/rmap96  
sd=asu2\_33,lun=/dev/rmap97  
sd=asu2\_34,lun=/dev/rmap98  
sd=asu2\_35,lun=/dev/rmap99  
sd=asu2\_36,lun=/dev/rmap100

```
sd=asu2_37,lun=/dev/rmap101
sd=asu2_38,lun=/dev/rmap102
sd=asu2_39,lun=/dev/rmap103
sd=asu2_40,lun=/dev/rmap104
sd=asu2_41,lun=/dev/rmap105
sd=asu2_42,lun=/dev/rmap106
sd=asu2_43,lun=/dev/rmap107
sd=asu2_44,lun=/dev/rmap108
sd=asu2_45,lun=/dev/rmap109
sd=asu2_46,lun=/dev/rmap110
sd=asu2_47,lun=/dev/rmap111
sd=asu2_48,lun=/dev/rmap112
sd=asu2_49,lun=/dev/rmap113
sd=asu2_50,lun=/dev/rmap114
sd=asu2_51,lun=/dev/rmap115
sd=asu2_52,lun=/dev/rmap116
sd=asu2_53,lun=/dev/rmap117
sd=asu2_54,lun=/dev/rmap118
sd=asu2_55,lun=/dev/rmap119
sd=asu2_56,lun=/dev/rmap120
sd=asu2_57,lun=/dev/rmap121
sd=asu2_58,lun=/dev/rmap122
sd=asu2_59,lun=/dev/rmap123
sd=asu2_60,lun=/dev/rmap124
sd=asu2_61,lun=/dev/rmap125
sd=asu2_62,lun=/dev/rmap126
sd=asu2_63,lun=/dev/rmap127
sd=asu2_64,lun=/dev/rmap128
sd=asu3_1,lun=/dev/rmap129
sd=asu3_2,lun=/dev/rmap130
sd=asu3_3,lun=/dev/rmap131
sd=asu3_4,lun=/dev/rmap132
sd=asu3_5,lun=/dev/rmap133
sd=asu3_6,lun=/dev/rmap134
sd=asu3_7,lun=/dev/rmap135
sd=asu3_8,lun=/dev/rmap136
sd=asu3_9,lun=/dev/rmap137
sd=asu3_10,lun=/dev/rmap138
sd=asu3_11,lun=/dev/rmap139
sd=asu3_12,lun=/dev/rmap140
sd=asu3_13,lun=/dev/rmap141
sd=asu3_14,lun=/dev/rmap142
rd=sustain,bsus=7610,startup=180,elapsed=10800,interval=60
```

## Ramp 100 Test Run

```
host=master
slaves=(slave1,slave2,slave3,slave4,slave5,slave6,slave7,slave8,slave9,slave10,slave
11,slave12,slave13,slave14,slave15,slave16,slave17,slave18,slave19,slave20,slave21,s
lave22,slave23,slave24,slave25,slave26,slave27,slave28,slave29,slave30,slave31,slave
32,slave33,slave34,slave35,slave36,slave37,slave38,slave39,slave40,slave41,slave42,s
lave43,slave44,slave45,slave46,slave47,slave48,slave49,slave50,slave51,slave52,slave
53,slave54,slave55,slave56,slave57,slave58,slave59,slave60,slave61,slave62,slave63,s
lave64,slave65,slave66,slave67,slave68,slave69,slave70,slave71,slave72,slave73,slave
74,slave75,slave76,slave77,slave78,slave79,slave80,slave81)

javaparms="-Xms1280m -Xmx1280m -Xss96k -Xgcpolicy:optavgpause"
sd=default,size=687194767360
#sd=default,size=343597383680
sd=asu1_1,lun=/dev/rmap1
sd=asu1_2,lun=/dev/rmap2
sd=asu1_3,lun=/dev/rmap3
```

sd=asul\_4,lun=/dev/rmap4  
sd=asul\_5,lun=/dev/rmap5  
sd=asul\_6,lun=/dev/rmap6  
sd=asul\_7,lun=/dev/rmap7  
sd=asul\_8,lun=/dev/rmap8  
sd=asul\_9,lun=/dev/rmap9  
sd=asul\_10,lun=/dev/rmap10  
sd=asul\_11,lun=/dev/rmap11  
sd=asul\_12,lun=/dev/rmap12  
sd=asul\_13,lun=/dev/rmap13  
sd=asul\_14,lun=/dev/rmap14  
sd=asul\_15,lun=/dev/rmap15  
sd=asul\_16,lun=/dev/rmap16  
sd=asul\_17,lun=/dev/rmap17  
sd=asul\_18,lun=/dev/rmap18  
sd=asul\_19,lun=/dev/rmap19  
sd=asul\_20,lun=/dev/rmap20  
sd=asul\_21,lun=/dev/rmap21  
sd=asul\_22,lun=/dev/rmap22  
sd=asul\_23,lun=/dev/rmap23  
sd=asul\_24,lun=/dev/rmap24  
sd=asul\_25,lun=/dev/rmap25  
sd=asul\_26,lun=/dev/rmap26  
sd=asul\_27,lun=/dev/rmap27  
sd=asul\_28,lun=/dev/rmap28  
sd=asul\_29,lun=/dev/rmap29  
sd=asul\_30,lun=/dev/rmap30  
sd=asul\_31,lun=/dev/rmap31  
sd=asul\_32,lun=/dev/rmap32  
sd=asul\_33,lun=/dev/rmap33  
sd=asul\_34,lun=/dev/rmap34  
sd=asul\_35,lun=/dev/rmap35  
sd=asul\_36,lun=/dev/rmap36  
sd=asul\_37,lun=/dev/rmap37  
sd=asul\_38,lun=/dev/rmap38  
sd=asul\_39,lun=/dev/rmap39  
sd=asul\_40,lun=/dev/rmap40  
sd=asul\_41,lun=/dev/rmap41  
sd=asul\_42,lun=/dev/rmap42  
sd=asul\_43,lun=/dev/rmap43  
sd=asul\_44,lun=/dev/rmap44  
sd=asul\_45,lun=/dev/rmap45  
sd=asul\_46,lun=/dev/rmap46  
sd=asul\_47,lun=/dev/rmap47  
sd=asul\_48,lun=/dev/rmap48  
sd=asul\_49,lun=/dev/rmap49  
sd=asul\_50,lun=/dev/rmap50  
sd=asul\_51,lun=/dev/rmap51  
sd=asul\_52,lun=/dev/rmap52  
sd=asul\_53,lun=/dev/rmap53  
sd=asul\_54,lun=/dev/rmap54  
sd=asul\_55,lun=/dev/rmap55  
sd=asul\_56,lun=/dev/rmap56  
sd=asul\_57,lun=/dev/rmap57  
sd=asul\_58,lun=/dev/rmap58  
sd=asul\_59,lun=/dev/rmap59  
sd=asul\_60,lun=/dev/rmap60  
sd=asul\_61,lun=/dev/rmap61  
sd=asul\_62,lun=/dev/rmap62  
sd=asul\_63,lun=/dev/rmap63  
sd=asul\_64,lun=/dev/rmap64  
sd=asu2\_1,lun=/dev/rmap65  
sd=asu2\_2,lun=/dev/rmap66

sd=asu2\_3,lun=/dev/rmap67  
sd=asu2\_4,lun=/dev/rmap68  
sd=asu2\_5,lun=/dev/rmap69  
sd=asu2\_6,lun=/dev/rmap70  
sd=asu2\_7,lun=/dev/rmap71  
sd=asu2\_8,lun=/dev/rmap72  
sd=asu2\_9,lun=/dev/rmap73  
sd=asu2\_10,lun=/dev/rmap74  
sd=asu2\_11,lun=/dev/rmap75  
sd=asu2\_12,lun=/dev/rmap76  
sd=asu2\_13,lun=/dev/rmap77  
sd=asu2\_14,lun=/dev/rmap78  
sd=asu2\_15,lun=/dev/rmap79  
sd=asu2\_16,lun=/dev/rmap80  
sd=asu2\_17,lun=/dev/rmap81  
sd=asu2\_18,lun=/dev/rmap82  
sd=asu2\_19,lun=/dev/rmap83  
sd=asu2\_20,lun=/dev/rmap84  
sd=asu2\_21,lun=/dev/rmap85  
sd=asu2\_22,lun=/dev/rmap86  
sd=asu2\_23,lun=/dev/rmap87  
sd=asu2\_24,lun=/dev/rmap88  
sd=asu2\_25,lun=/dev/rmap89  
sd=asu2\_26,lun=/dev/rmap90  
sd=asu2\_27,lun=/dev/rmap91  
sd=asu2\_28,lun=/dev/rmap92  
sd=asu2\_29,lun=/dev/rmap93  
sd=asu2\_30,lun=/dev/rmap94  
sd=asu2\_31,lun=/dev/rmap95  
sd=asu2\_32,lun=/dev/rmap96  
sd=asu2\_33,lun=/dev/rmap97  
sd=asu2\_34,lun=/dev/rmap98  
sd=asu2\_35,lun=/dev/rmap99  
sd=asu2\_36,lun=/dev/rmap100  
sd=asu2\_37,lun=/dev/rmap101  
sd=asu2\_38,lun=/dev/rmap102  
sd=asu2\_39,lun=/dev/rmap103  
sd=asu2\_40,lun=/dev/rmap104  
sd=asu2\_41,lun=/dev/rmap105  
sd=asu2\_42,lun=/dev/rmap106  
sd=asu2\_43,lun=/dev/rmap107  
sd=asu2\_44,lun=/dev/rmap108  
sd=asu2\_45,lun=/dev/rmap109  
sd=asu2\_46,lun=/dev/rmap110  
sd=asu2\_47,lun=/dev/rmap111  
sd=asu2\_48,lun=/dev/rmap112  
sd=asu2\_49,lun=/dev/rmap113  
sd=asu2\_50,lun=/dev/rmap114  
sd=asu2\_51,lun=/dev/rmap115  
sd=asu2\_52,lun=/dev/rmap116  
sd=asu2\_53,lun=/dev/rmap117  
sd=asu2\_54,lun=/dev/rmap118  
sd=asu2\_55,lun=/dev/rmap119  
sd=asu2\_56,lun=/dev/rmap120  
sd=asu2\_57,lun=/dev/rmap121  
sd=asu2\_58,lun=/dev/rmap122  
sd=asu2\_59,lun=/dev/rmap123  
sd=asu2\_60,lun=/dev/rmap124  
sd=asu2\_61,lun=/dev/rmap125  
sd=asu2\_62,lun=/dev/rmap126  
sd=asu2\_63,lun=/dev/rmap127  
sd=asu2\_64,lun=/dev/rmap128  
sd=asu3\_1,lun=/dev/rmap129

```
sd=asu3_2,lun=/dev/rmap130
sd=asu3_3,lun=/dev/rmap131
sd=asu3_4,lun=/dev/rmap132
sd=asu3_5,lun=/dev/rmap133
sd=asu3_6,lun=/dev/rmap134
sd=asu3_7,lun=/dev/rmap135
sd=asu3_8,lun=/dev/rmap136
sd=asu3_9,lun=/dev/rmap137
sd=asu3_10,lun=/dev/rmap138
sd=asu3_11,lun=/dev/rmap139
sd=asu3_12,lun=/dev/rmap140
sd=asu3_13,lun=/dev/rmap141
sd=asu3_14,lun=/dev/rmap142
rd=ramp_100,bsus=7610,startup=180,elapsed=600,interval=60
```

## Ramp 95 Test Run

```
host=master
slaves=(slave1,slave2,slave3,slave4,slave5,slave6,slave7,slave8,slave9,slave10,slave
11,slave12,slave13,slave14,slave15,slave16,slave17,slave18,slave19,slave20,slave21,s
lave22,slave23,slave24,slave25,slave26,slave27,slave28,slave29,slave30,slave31,slave
32,slave33,slave34,slave35,slave36,slave37,slave38,slave39,slave40,slave41,slave42,s
lave43,slave44,slave45,slave46,slave47,slave48,slave49,slave50,slave51,slave52,slave
53,slave54,slave55,slave56,slave57,slave58,slave59,slave60,slave61,slave62,slave63,s
lave64,slave65,slave66,slave67,slave68,slave69,slave70,slave71,slave72,slave73,slave
74,slave75,slave76,slave77,slave78,slave79,slave80,slave81)

javaparms="-Xms1280m -Xmx1280m -Xss96k -Xgcpolicy:optavgpause"
sd=default,size=687194767360
#sd=default,size=343597383680
sd=asu1_1,lun=/dev/rmap1
sd=asu1_2,lun=/dev/rmap2
sd=asu1_3,lun=/dev/rmap3
sd=asu1_4,lun=/dev/rmap4
sd=asu1_5,lun=/dev/rmap5
sd=asu1_6,lun=/dev/rmap6
sd=asu1_7,lun=/dev/rmap7
sd=asu1_8,lun=/dev/rmap8
sd=asu1_9,lun=/dev/rmap9
sd=asu1_10,lun=/dev/rmap10
sd=asu1_11,lun=/dev/rmap11
sd=asu1_12,lun=/dev/rmap12
sd=asu1_13,lun=/dev/rmap13
sd=asu1_14,lun=/dev/rmap14
sd=asu1_15,lun=/dev/rmap15
sd=asu1_16,lun=/dev/rmap16
sd=asu1_17,lun=/dev/rmap17
sd=asu1_18,lun=/dev/rmap18
sd=asu1_19,lun=/dev/rmap19
sd=asu1_20,lun=/dev/rmap20
sd=asu1_21,lun=/dev/rmap21
sd=asu1_22,lun=/dev/rmap22
sd=asu1_23,lun=/dev/rmap23
sd=asu1_24,lun=/dev/rmap24
sd=asu1_25,lun=/dev/rmap25
sd=asu1_26,lun=/dev/rmap26
sd=asu1_27,lun=/dev/rmap27
sd=asu1_28,lun=/dev/rmap28
sd=asu1_29,lun=/dev/rmap29
sd=asu1_30,lun=/dev/rmap30
sd=asu1_31,lun=/dev/rmap31
sd=asu1_32,lun=/dev/rmap32
```

sd=asu1\_33, lun=/dev/rmap33  
sd=asu1\_34, lun=/dev/rmap34  
sd=asu1\_35, lun=/dev/rmap35  
sd=asu1\_36, lun=/dev/rmap36  
sd=asu1\_37, lun=/dev/rmap37  
sd=asu1\_38, lun=/dev/rmap38  
sd=asu1\_39, lun=/dev/rmap39  
sd=asu1\_40, lun=/dev/rmap40  
sd=asu1\_41, lun=/dev/rmap41  
sd=asu1\_42, lun=/dev/rmap42  
sd=asu1\_43, lun=/dev/rmap43  
sd=asu1\_44, lun=/dev/rmap44  
sd=asu1\_45, lun=/dev/rmap45  
sd=asu1\_46, lun=/dev/rmap46  
sd=asu1\_47, lun=/dev/rmap47  
sd=asu1\_48, lun=/dev/rmap48  
sd=asu1\_49, lun=/dev/rmap49  
sd=asu1\_50, lun=/dev/rmap50  
sd=asu1\_51, lun=/dev/rmap51  
sd=asu1\_52, lun=/dev/rmap52  
sd=asu1\_53, lun=/dev/rmap53  
sd=asu1\_54, lun=/dev/rmap54  
sd=asu1\_55, lun=/dev/rmap55  
sd=asu1\_56, lun=/dev/rmap56  
sd=asu1\_57, lun=/dev/rmap57  
sd=asu1\_58, lun=/dev/rmap58  
sd=asu1\_59, lun=/dev/rmap59  
sd=asu1\_60, lun=/dev/rmap60  
sd=asu1\_61, lun=/dev/rmap61  
sd=asu1\_62, lun=/dev/rmap62  
sd=asu1\_63, lun=/dev/rmap63  
sd=asu1\_64, lun=/dev/rmap64  
sd=asu2\_1, lun=/dev/rmap65  
sd=asu2\_2, lun=/dev/rmap66  
sd=asu2\_3, lun=/dev/rmap67  
sd=asu2\_4, lun=/dev/rmap68  
sd=asu2\_5, lun=/dev/rmap69  
sd=asu2\_6, lun=/dev/rmap70  
sd=asu2\_7, lun=/dev/rmap71  
sd=asu2\_8, lun=/dev/rmap72  
sd=asu2\_9, lun=/dev/rmap73  
sd=asu2\_10, lun=/dev/rmap74  
sd=asu2\_11, lun=/dev/rmap75  
sd=asu2\_12, lun=/dev/rmap76  
sd=asu2\_13, lun=/dev/rmap77  
sd=asu2\_14, lun=/dev/rmap78  
sd=asu2\_15, lun=/dev/rmap79  
sd=asu2\_16, lun=/dev/rmap80  
sd=asu2\_17, lun=/dev/rmap81  
sd=asu2\_18, lun=/dev/rmap82  
sd=asu2\_19, lun=/dev/rmap83  
sd=asu2\_20, lun=/dev/rmap84  
sd=asu2\_21, lun=/dev/rmap85  
sd=asu2\_22, lun=/dev/rmap86  
sd=asu2\_23, lun=/dev/rmap87  
sd=asu2\_24, lun=/dev/rmap88  
sd=asu2\_25, lun=/dev/rmap89  
sd=asu2\_26, lun=/dev/rmap90  
sd=asu2\_27, lun=/dev/rmap91  
sd=asu2\_28, lun=/dev/rmap92  
sd=asu2\_29, lun=/dev/rmap93  
sd=asu2\_30, lun=/dev/rmap94  
sd=asu2\_31, lun=/dev/rmap95

```
sd=asu2_32,lun=/dev/rmap96
sd=asu2_33,lun=/dev/rmap97
sd=asu2_34,lun=/dev/rmap98
sd=asu2_35,lun=/dev/rmap99
sd=asu2_36,lun=/dev/rmap100
sd=asu2_37,lun=/dev/rmap101
sd=asu2_38,lun=/dev/rmap102
sd=asu2_39,lun=/dev/rmap103
sd=asu2_40,lun=/dev/rmap104
sd=asu2_41,lun=/dev/rmap105
sd=asu2_42,lun=/dev/rmap106
sd=asu2_43,lun=/dev/rmap107
sd=asu2_44,lun=/dev/rmap108
sd=asu2_45,lun=/dev/rmap109
sd=asu2_46,lun=/dev/rmap110
sd=asu2_47,lun=/dev/rmap111
sd=asu2_48,lun=/dev/rmap112
sd=asu2_49,lun=/dev/rmap113
sd=asu2_50,lun=/dev/rmap114
sd=asu2_51,lun=/dev/rmap115
sd=asu2_52,lun=/dev/rmap116
sd=asu2_53,lun=/dev/rmap117
sd=asu2_54,lun=/dev/rmap118
sd=asu2_55,lun=/dev/rmap119
sd=asu2_56,lun=/dev/rmap120
sd=asu2_57,lun=/dev/rmap121
sd=asu2_58,lun=/dev/rmap122
sd=asu2_59,lun=/dev/rmap123
sd=asu2_60,lun=/dev/rmap124
sd=asu2_61,lun=/dev/rmap125
sd=asu2_62,lun=/dev/rmap126
sd=asu2_63,lun=/dev/rmap127
sd=asu2_64,lun=/dev/rmap128
sd=asu3_1,lun=/dev/rmap129
sd=asu3_2,lun=/dev/rmap130
sd=asu3_3,lun=/dev/rmap131
sd=asu3_4,lun=/dev/rmap132
sd=asu3_5,lun=/dev/rmap133
sd=asu3_6,lun=/dev/rmap134
sd=asu3_7,lun=/dev/rmap135
sd=asu3_8,lun=/dev/rmap136
sd=asu3_9,lun=/dev/rmap137
sd=asu3_10,lun=/dev/rmap138
sd=asu3_11,lun=/dev/rmap139
sd=asu3_12,lun=/dev/rmap140
sd=asu3_13,lun=/dev/rmap141
sd=asu3_14,lun=/dev/rmap142
rd=ramp_95,bsus=7230,startup=180,elapsed=600,interval=60
```

## Ramp 90 Test Run

```
host=master
slaves=(slave1,slave2,slave3,slave4,slave5,slave6,slave7,slave8,slave9,slave10,slave
11,slave12,slave13,slave14,slave15,slave16,slave17,slave18,slave19,slave20,slave21,s
lave22,slave23,slave24,slave25,slave26,slave27,slave28,slave29,slave30,slave31,slave
32,slave33,slave34,slave35,slave36,slave37,slave38,slave39,slave40,slave41,slave42,s
lave43,slave44,slave45,slave46,slave47,slave48,slave49,slave50,slave51,slave52,slave
53,slave54,slave55,slave56,slave57,slave58,slave59,slave60,slave61,slave62,slave63,s
lave64,slave65,slave66,slave67,slave68,slave69,slave70,slave71,slave72,slave73,slave
74,slave75,slave76,slave77,slave78,slave79,slave80,slave81)

javaparms="-Xms1280m -Xmx1280m -Xss96k -Xgcpolicy:optavgpause"
```

```
sd=default,size=687194767360
#sd=default,size=343597383680
sd=asul_1,lun=/dev/rmap1
sd=asul_2,lun=/dev/rmap2
sd=asul_3,lun=/dev/rmap3
sd=asul_4,lun=/dev/rmap4
sd=asul_5,lun=/dev/rmap5
sd=asul_6,lun=/dev/rmap6
sd=asul_7,lun=/dev/rmap7
sd=asul_8,lun=/dev/rmap8
sd=asul_9,lun=/dev/rmap9
sd=asul_10,lun=/dev/rmap10
sd=asul_11,lun=/dev/rmap11
sd=asul_12,lun=/dev/rmap12
sd=asul_13,lun=/dev/rmap13
sd=asul_14,lun=/dev/rmap14
sd=asul_15,lun=/dev/rmap15
sd=asul_16,lun=/dev/rmap16
sd=asul_17,lun=/dev/rmap17
sd=asul_18,lun=/dev/rmap18
sd=asul_19,lun=/dev/rmap19
sd=asul_20,lun=/dev/rmap20
sd=asul_21,lun=/dev/rmap21
sd=asul_22,lun=/dev/rmap22
sd=asul_23,lun=/dev/rmap23
sd=asul_24,lun=/dev/rmap24
sd=asul_25,lun=/dev/rmap25
sd=asul_26,lun=/dev/rmap26
sd=asul_27,lun=/dev/rmap27
sd=asul_28,lun=/dev/rmap28
sd=asul_29,lun=/dev/rmap29
sd=asul_30,lun=/dev/rmap30
sd=asul_31,lun=/dev/rmap31
sd=asul_32,lun=/dev/rmap32
sd=asul_33,lun=/dev/rmap33
sd=asul_34,lun=/dev/rmap34
sd=asul_35,lun=/dev/rmap35
sd=asul_36,lun=/dev/rmap36
sd=asul_37,lun=/dev/rmap37
sd=asul_38,lun=/dev/rmap38
sd=asul_39,lun=/dev/rmap39
sd=asul_40,lun=/dev/rmap40
sd=asul_41,lun=/dev/rmap41
sd=asul_42,lun=/dev/rmap42
sd=asul_43,lun=/dev/rmap43
sd=asul_44,lun=/dev/rmap44
sd=asul_45,lun=/dev/rmap45
sd=asul_46,lun=/dev/rmap46
sd=asul_47,lun=/dev/rmap47
sd=asul_48,lun=/dev/rmap48
sd=asul_49,lun=/dev/rmap49
sd=asul_50,lun=/dev/rmap50
sd=asul_51,lun=/dev/rmap51
sd=asul_52,lun=/dev/rmap52
sd=asul_53,lun=/dev/rmap53
sd=asul_54,lun=/dev/rmap54
sd=asul_55,lun=/dev/rmap55
sd=asul_56,lun=/dev/rmap56
sd=asul_57,lun=/dev/rmap57
sd=asul_58,lun=/dev/rmap58
sd=asul_59,lun=/dev/rmap59
sd=asul_60,lun=/dev/rmap60
sd=asul_61,lun=/dev/rmap61
```



sd=asu1\_62,lun=/dev/rmap62  
sd=asu1\_63,lun=/dev/rmap63  
sd=asu1\_64,lun=/dev/rmap64  
sd=asu2\_1,lun=/dev/rmap65  
sd=asu2\_2,lun=/dev/rmap66  
sd=asu2\_3,lun=/dev/rmap67  
sd=asu2\_4,lun=/dev/rmap68  
sd=asu2\_5,lun=/dev/rmap69  
sd=asu2\_6,lun=/dev/rmap70  
sd=asu2\_7,lun=/dev/rmap71  
sd=asu2\_8,lun=/dev/rmap72  
sd=asu2\_9,lun=/dev/rmap73  
sd=asu2\_10,lun=/dev/rmap74  
sd=asu2\_11,lun=/dev/rmap75  
sd=asu2\_12,lun=/dev/rmap76  
sd=asu2\_13,lun=/dev/rmap77  
sd=asu2\_14,lun=/dev/rmap78  
sd=asu2\_15,lun=/dev/rmap79  
sd=asu2\_16,lun=/dev/rmap80  
sd=asu2\_17,lun=/dev/rmap81  
sd=asu2\_18,lun=/dev/rmap82  
sd=asu2\_19,lun=/dev/rmap83  
sd=asu2\_20,lun=/dev/rmap84  
sd=asu2\_21,lun=/dev/rmap85  
sd=asu2\_22,lun=/dev/rmap86  
sd=asu2\_23,lun=/dev/rmap87  
sd=asu2\_24,lun=/dev/rmap88  
sd=asu2\_25,lun=/dev/rmap89  
sd=asu2\_26,lun=/dev/rmap90  
sd=asu2\_27,lun=/dev/rmap91  
sd=asu2\_28,lun=/dev/rmap92  
sd=asu2\_29,lun=/dev/rmap93  
sd=asu2\_30,lun=/dev/rmap94  
sd=asu2\_31,lun=/dev/rmap95  
sd=asu2\_32,lun=/dev/rmap96  
sd=asu2\_33,lun=/dev/rmap97  
sd=asu2\_34,lun=/dev/rmap98  
sd=asu2\_35,lun=/dev/rmap99  
sd=asu2\_36,lun=/dev/rmap100  
sd=asu2\_37,lun=/dev/rmap101  
sd=asu2\_38,lun=/dev/rmap102  
sd=asu2\_39,lun=/dev/rmap103  
sd=asu2\_40,lun=/dev/rmap104  
sd=asu2\_41,lun=/dev/rmap105  
sd=asu2\_42,lun=/dev/rmap106  
sd=asu2\_43,lun=/dev/rmap107  
sd=asu2\_44,lun=/dev/rmap108  
sd=asu2\_45,lun=/dev/rmap109  
sd=asu2\_46,lun=/dev/rmap110  
sd=asu2\_47,lun=/dev/rmap111  
sd=asu2\_48,lun=/dev/rmap112  
sd=asu2\_49,lun=/dev/rmap113  
sd=asu2\_50,lun=/dev/rmap114  
sd=asu2\_51,lun=/dev/rmap115  
sd=asu2\_52,lun=/dev/rmap116  
sd=asu2\_53,lun=/dev/rmap117  
sd=asu2\_54,lun=/dev/rmap118  
sd=asu2\_55,lun=/dev/rmap119  
sd=asu2\_56,lun=/dev/rmap120  
sd=asu2\_57,lun=/dev/rmap121  
sd=asu2\_58,lun=/dev/rmap122  
sd=asu2\_59,lun=/dev/rmap123  
sd=asu2\_60,lun=/dev/rmap124

```
sd=asu2_61,lun=/dev/rmap125
sd=asu2_62,lun=/dev/rmap126
sd=asu2_63,lun=/dev/rmap127
sd=asu2_64,lun=/dev/rmap128
sd=asu3_1,lun=/dev/rmap129
sd=asu3_2,lun=/dev/rmap130
sd=asu3_3,lun=/dev/rmap131
sd=asu3_4,lun=/dev/rmap132
sd=asu3_5,lun=/dev/rmap133
sd=asu3_6,lun=/dev/rmap134
sd=asu3_7,lun=/dev/rmap135
sd=asu3_8,lun=/dev/rmap136
sd=asu3_9,lun=/dev/rmap137
sd=asu3_10,lun=/dev/rmap138
sd=asu3_11,lun=/dev/rmap139
sd=asu3_12,lun=/dev/rmap140
sd=asu3_13,lun=/dev/rmap141
sd=asu3_14,lun=/dev/rmap142
rd=ramp_90,bsus=6849,startup=180,elapsed=600,interval=60
```

### Ramp 80 Test Run

```
host=master
slaves=(slave1,slave2,slave3,slave4,slave5,slave6,slave7,slave8,slave9,slave10,slave
11,slave12,slave13,slave14,slave15,slave16,slave17,slave18,slave19,slave20,slave21,s
lave22,slave23,slave24,slave25,slave26,slave27,slave28,slave29,slave30,slave31,slave
32,slave33,slave34,slave35,slave36,slave37,slave38,slave39,slave40,slave41,slave42,s
lave43,slave44,slave45,slave46,slave47,slave48,slave49,slave50,slave51,slave52,slave
53,slave54,slave55,slave56,slave57,slave58,slave59,slave60,slave61,slave62,slave63,s
lave64,slave65,slave66,slave67,slave68,slave69,slave70,slave71,slave72,slave73,slave
74,slave75,slave76,slave77,slave78,slave79,slave80,slave81)

javaparms="-Xms1280m -Xmx1280m -Xss96k -Xgcpolicy:optavgpause"
sd=default,size=687194767360
#sd=default,size=343597383680
sd=asu1_1,lun=/dev/rmap1
sd=asu1_2,lun=/dev/rmap2
sd=asu1_3,lun=/dev/rmap3
sd=asu1_4,lun=/dev/rmap4
sd=asu1_5,lun=/dev/rmap5
sd=asu1_6,lun=/dev/rmap6
sd=asu1_7,lun=/dev/rmap7
sd=asu1_8,lun=/dev/rmap8
sd=asu1_9,lun=/dev/rmap9
sd=asu1_10,lun=/dev/rmap10
sd=asu1_11,lun=/dev/rmap11
sd=asu1_12,lun=/dev/rmap12
sd=asu1_13,lun=/dev/rmap13
sd=asu1_14,lun=/dev/rmap14
sd=asu1_15,lun=/dev/rmap15
sd=asu1_16,lun=/dev/rmap16
sd=asu1_17,lun=/dev/rmap17
sd=asu1_18,lun=/dev/rmap18
sd=asu1_19,lun=/dev/rmap19
sd=asu1_20,lun=/dev/rmap20
sd=asu1_21,lun=/dev/rmap21
sd=asu1_22,lun=/dev/rmap22
sd=asu1_23,lun=/dev/rmap23
sd=asu1_24,lun=/dev/rmap24
sd=asu1_25,lun=/dev/rmap25
sd=asu1_26,lun=/dev/rmap26
sd=asu1_27,lun=/dev/rmap27
```

sd=asu1\_28,lun=/dev/rmap28  
sd=asu1\_29,lun=/dev/rmap29  
sd=asu1\_30,lun=/dev/rmap30  
sd=asu1\_31,lun=/dev/rmap31  
sd=asu1\_32,lun=/dev/rmap32  
sd=asu1\_33,lun=/dev/rmap33  
sd=asu1\_34,lun=/dev/rmap34  
sd=asu1\_35,lun=/dev/rmap35  
sd=asu1\_36,lun=/dev/rmap36  
sd=asu1\_37,lun=/dev/rmap37  
sd=asu1\_38,lun=/dev/rmap38  
sd=asu1\_39,lun=/dev/rmap39  
sd=asu1\_40,lun=/dev/rmap40  
sd=asu1\_41,lun=/dev/rmap41  
sd=asu1\_42,lun=/dev/rmap42  
sd=asu1\_43,lun=/dev/rmap43  
sd=asu1\_44,lun=/dev/rmap44  
sd=asu1\_45,lun=/dev/rmap45  
sd=asu1\_46,lun=/dev/rmap46  
sd=asu1\_47,lun=/dev/rmap47  
sd=asu1\_48,lun=/dev/rmap48  
sd=asu1\_49,lun=/dev/rmap49  
sd=asu1\_50,lun=/dev/rmap50  
sd=asu1\_51,lun=/dev/rmap51  
sd=asu1\_52,lun=/dev/rmap52  
sd=asu1\_53,lun=/dev/rmap53  
sd=asu1\_54,lun=/dev/rmap54  
sd=asu1\_55,lun=/dev/rmap55  
sd=asu1\_56,lun=/dev/rmap56  
sd=asu1\_57,lun=/dev/rmap57  
sd=asu1\_58,lun=/dev/rmap58  
sd=asu1\_59,lun=/dev/rmap59  
sd=asu1\_60,lun=/dev/rmap60  
sd=asu1\_61,lun=/dev/rmap61  
sd=asu1\_62,lun=/dev/rmap62  
sd=asu1\_63,lun=/dev/rmap63  
sd=asu1\_64,lun=/dev/rmap64  
sd=asu2\_1,lun=/dev/rmap65  
sd=asu2\_2,lun=/dev/rmap66  
sd=asu2\_3,lun=/dev/rmap67  
sd=asu2\_4,lun=/dev/rmap68  
sd=asu2\_5,lun=/dev/rmap69  
sd=asu2\_6,lun=/dev/rmap70  
sd=asu2\_7,lun=/dev/rmap71  
sd=asu2\_8,lun=/dev/rmap72  
sd=asu2\_9,lun=/dev/rmap73  
sd=asu2\_10,lun=/dev/rmap74  
sd=asu2\_11,lun=/dev/rmap75  
sd=asu2\_12,lun=/dev/rmap76  
sd=asu2\_13,lun=/dev/rmap77  
sd=asu2\_14,lun=/dev/rmap78  
sd=asu2\_15,lun=/dev/rmap79  
sd=asu2\_16,lun=/dev/rmap80  
sd=asu2\_17,lun=/dev/rmap81  
sd=asu2\_18,lun=/dev/rmap82  
sd=asu2\_19,lun=/dev/rmap83  
sd=asu2\_20,lun=/dev/rmap84  
sd=asu2\_21,lun=/dev/rmap85  
sd=asu2\_22,lun=/dev/rmap86  
sd=asu2\_23,lun=/dev/rmap87  
sd=asu2\_24,lun=/dev/rmap88  
sd=asu2\_25,lun=/dev/rmap89  
sd=asu2\_26,lun=/dev/rmap90

```
sd=asu2_27,lun=/dev/rmap91
sd=asu2_28,lun=/dev/rmap92
sd=asu2_29,lun=/dev/rmap93
sd=asu2_30,lun=/dev/rmap94
sd=asu2_31,lun=/dev/rmap95
sd=asu2_32,lun=/dev/rmap96
sd=asu2_33,lun=/dev/rmap97
sd=asu2_34,lun=/dev/rmap98
sd=asu2_35,lun=/dev/rmap99
sd=asu2_36,lun=/dev/rmap100
sd=asu2_37,lun=/dev/rmap101
sd=asu2_38,lun=/dev/rmap102
sd=asu2_39,lun=/dev/rmap103
sd=asu2_40,lun=/dev/rmap104
sd=asu2_41,lun=/dev/rmap105
sd=asu2_42,lun=/dev/rmap106
sd=asu2_43,lun=/dev/rmap107
sd=asu2_44,lun=/dev/rmap108
sd=asu2_45,lun=/dev/rmap109
sd=asu2_46,lun=/dev/rmap110
sd=asu2_47,lun=/dev/rmap111
sd=asu2_48,lun=/dev/rmap112
sd=asu2_49,lun=/dev/rmap113
sd=asu2_50,lun=/dev/rmap114
sd=asu2_51,lun=/dev/rmap115
sd=asu2_52,lun=/dev/rmap116
sd=asu2_53,lun=/dev/rmap117
sd=asu2_54,lun=/dev/rmap118
sd=asu2_55,lun=/dev/rmap119
sd=asu2_56,lun=/dev/rmap120
sd=asu2_57,lun=/dev/rmap121
sd=asu2_58,lun=/dev/rmap122
sd=asu2_59,lun=/dev/rmap123
sd=asu2_60,lun=/dev/rmap124
sd=asu2_61,lun=/dev/rmap125
sd=asu2_62,lun=/dev/rmap126
sd=asu2_63,lun=/dev/rmap127
sd=asu2_64,lun=/dev/rmap128
sd=asu3_1,lun=/dev/rmap129
sd=asu3_2,lun=/dev/rmap130
sd=asu3_3,lun=/dev/rmap131
sd=asu3_4,lun=/dev/rmap132
sd=asu3_5,lun=/dev/rmap133
sd=asu3_6,lun=/dev/rmap134
sd=asu3_7,lun=/dev/rmap135
sd=asu3_8,lun=/dev/rmap136
sd=asu3_9,lun=/dev/rmap137
sd=asu3_10,lun=/dev/rmap138
sd=asu3_11,lun=/dev/rmap139
sd=asu3_12,lun=/dev/rmap140
sd=asu3_13,lun=/dev/rmap141
sd=asu3_14,lun=/dev/rmap142
rd=ramp_80,bsus=6088,startup=180,elapsed=600,interval=60
```

## Ramp 50 Test Run

```
host=master
slaves=(slave1,slave2,slave3,slave4,slave5,slave6,slave7,slave8,slave9,slave10,slave
11,slave12,slave13,slave14,slave15,slave16,slave17,slave18,slave19,slave20,slave21,s
lave22,slave23,slave24,slave25,slave26,slave27,slave28,slave29,slave30,slave31,slave
32,slave33,slave34,slave35,slave36,slave37,slave38,slave39,slave40,slave41,slave42,s
lave43,slave44,slave45,slave46,slave47,slave48,slave49,slave50,slave51,slave52,slave
```

53,slave54,slave55,slave56,slave57,slave58,slave59,slave60,slave61,slave62,slave63,slave64,slave65,slave66,slave67,slave68,slave69,slave70,slave71,slave72,slave73,slave74,slave75,slave76,slave77,slave78,slave79,slave80,slave81)

```
javaparms="-Xms1280m -Xmx1280m -Xss96k -Xgcpolicy:optavgpause"  
sd=default,size=687194767360  
#sd=default,size=343597383680  
sd=asul_1,lun=/dev/rmap1  
sd=asul_2,lun=/dev/rmap2  
sd=asul_3,lun=/dev/rmap3  
sd=asul_4,lun=/dev/rmap4  
sd=asul_5,lun=/dev/rmap5  
sd=asul_6,lun=/dev/rmap6  
sd=asul_7,lun=/dev/rmap7  
sd=asul_8,lun=/dev/rmap8  
sd=asul_9,lun=/dev/rmap9  
sd=asul_10,lun=/dev/rmap10  
sd=asul_11,lun=/dev/rmap11  
sd=asul_12,lun=/dev/rmap12  
sd=asul_13,lun=/dev/rmap13  
sd=asul_14,lun=/dev/rmap14  
sd=asul_15,lun=/dev/rmap15  
sd=asul_16,lun=/dev/rmap16  
sd=asul_17,lun=/dev/rmap17  
sd=asul_18,lun=/dev/rmap18  
sd=asul_19,lun=/dev/rmap19  
sd=asul_20,lun=/dev/rmap20  
sd=asul_21,lun=/dev/rmap21  
sd=asul_22,lun=/dev/rmap22  
sd=asul_23,lun=/dev/rmap23  
sd=asul_24,lun=/dev/rmap24  
sd=asul_25,lun=/dev/rmap25  
sd=asul_26,lun=/dev/rmap26  
sd=asul_27,lun=/dev/rmap27  
sd=asul_28,lun=/dev/rmap28  
sd=asul_29,lun=/dev/rmap29  
sd=asul_30,lun=/dev/rmap30  
sd=asul_31,lun=/dev/rmap31  
sd=asul_32,lun=/dev/rmap32  
sd=asul_33,lun=/dev/rmap33  
sd=asul_34,lun=/dev/rmap34  
sd=asul_35,lun=/dev/rmap35  
sd=asul_36,lun=/dev/rmap36  
sd=asul_37,lun=/dev/rmap37  
sd=asul_38,lun=/dev/rmap38  
sd=asul_39,lun=/dev/rmap39  
sd=asul_40,lun=/dev/rmap40  
sd=asul_41,lun=/dev/rmap41  
sd=asul_42,lun=/dev/rmap42  
sd=asul_43,lun=/dev/rmap43  
sd=asul_44,lun=/dev/rmap44  
sd=asul_45,lun=/dev/rmap45  
sd=asul_46,lun=/dev/rmap46  
sd=asul_47,lun=/dev/rmap47  
sd=asul_48,lun=/dev/rmap48  
sd=asul_49,lun=/dev/rmap49  
sd=asul_50,lun=/dev/rmap50  
sd=asul_51,lun=/dev/rmap51  
sd=asul_52,lun=/dev/rmap52  
sd=asul_53,lun=/dev/rmap53  
sd=asul_54,lun=/dev/rmap54  
sd=asul_55,lun=/dev/rmap55  
sd=asul_56,lun=/dev/rmap56
```

sd=asu1\_57,lun=/dev/rmap57  
sd=asu1\_58,lun=/dev/rmap58  
sd=asu1\_59,lun=/dev/rmap59  
sd=asu1\_60,lun=/dev/rmap60  
sd=asu1\_61,lun=/dev/rmap61  
sd=asu1\_62,lun=/dev/rmap62  
sd=asu1\_63,lun=/dev/rmap63  
sd=asu1\_64,lun=/dev/rmap64  
sd=asu2\_1,lun=/dev/rmap65  
sd=asu2\_2,lun=/dev/rmap66  
sd=asu2\_3,lun=/dev/rmap67  
sd=asu2\_4,lun=/dev/rmap68  
sd=asu2\_5,lun=/dev/rmap69  
sd=asu2\_6,lun=/dev/rmap70  
sd=asu2\_7,lun=/dev/rmap71  
sd=asu2\_8,lun=/dev/rmap72  
sd=asu2\_9,lun=/dev/rmap73  
sd=asu2\_10,lun=/dev/rmap74  
sd=asu2\_11,lun=/dev/rmap75  
sd=asu2\_12,lun=/dev/rmap76  
sd=asu2\_13,lun=/dev/rmap77  
sd=asu2\_14,lun=/dev/rmap78  
sd=asu2\_15,lun=/dev/rmap79  
sd=asu2\_16,lun=/dev/rmap80  
sd=asu2\_17,lun=/dev/rmap81  
sd=asu2\_18,lun=/dev/rmap82  
sd=asu2\_19,lun=/dev/rmap83  
sd=asu2\_20,lun=/dev/rmap84  
sd=asu2\_21,lun=/dev/rmap85  
sd=asu2\_22,lun=/dev/rmap86  
sd=asu2\_23,lun=/dev/rmap87  
sd=asu2\_24,lun=/dev/rmap88  
sd=asu2\_25,lun=/dev/rmap89  
sd=asu2\_26,lun=/dev/rmap90  
sd=asu2\_27,lun=/dev/rmap91  
sd=asu2\_28,lun=/dev/rmap92  
sd=asu2\_29,lun=/dev/rmap93  
sd=asu2\_30,lun=/dev/rmap94  
sd=asu2\_31,lun=/dev/rmap95  
sd=asu2\_32,lun=/dev/rmap96  
sd=asu2\_33,lun=/dev/rmap97  
sd=asu2\_34,lun=/dev/rmap98  
sd=asu2\_35,lun=/dev/rmap99  
sd=asu2\_36,lun=/dev/rmap100  
sd=asu2\_37,lun=/dev/rmap101  
sd=asu2\_38,lun=/dev/rmap102  
sd=asu2\_39,lun=/dev/rmap103  
sd=asu2\_40,lun=/dev/rmap104  
sd=asu2\_41,lun=/dev/rmap105  
sd=asu2\_42,lun=/dev/rmap106  
sd=asu2\_43,lun=/dev/rmap107  
sd=asu2\_44,lun=/dev/rmap108  
sd=asu2\_45,lun=/dev/rmap109  
sd=asu2\_46,lun=/dev/rmap110  
sd=asu2\_47,lun=/dev/rmap111  
sd=asu2\_48,lun=/dev/rmap112  
sd=asu2\_49,lun=/dev/rmap113  
sd=asu2\_50,lun=/dev/rmap114  
sd=asu2\_51,lun=/dev/rmap115  
sd=asu2\_52,lun=/dev/rmap116  
sd=asu2\_53,lun=/dev/rmap117  
sd=asu2\_54,lun=/dev/rmap118  
sd=asu2\_55,lun=/dev/rmap119

```
sd=asu2_56,lun=/dev/rmap120
sd=asu2_57,lun=/dev/rmap121
sd=asu2_58,lun=/dev/rmap122
sd=asu2_59,lun=/dev/rmap123
sd=asu2_60,lun=/dev/rmap124
sd=asu2_61,lun=/dev/rmap125
sd=asu2_62,lun=/dev/rmap126
sd=asu2_63,lun=/dev/rmap127
sd=asu2_64,lun=/dev/rmap128
sd=asu3_1,lun=/dev/rmap129
sd=asu3_2,lun=/dev/rmap130
sd=asu3_3,lun=/dev/rmap131
sd=asu3_4,lun=/dev/rmap132
sd=asu3_5,lun=/dev/rmap133
sd=asu3_6,lun=/dev/rmap134
sd=asu3_7,lun=/dev/rmap135
sd=asu3_8,lun=/dev/rmap136
sd=asu3_9,lun=/dev/rmap137
sd=asu3_10,lun=/dev/rmap138
sd=asu3_11,lun=/dev/rmap139
sd=asu3_12,lun=/dev/rmap140
sd=asu3_13,lun=/dev/rmap141
sd=asu3_14,lun=/dev/rmap142
rd=ramp_50,bsus=3805,startup=180,elapsed=600,interval=60
```

## Ramp 10 Test Run

```
host=master
slaves=(slave1,slave2,slave3,slave4,slave5,slave6,slave7,slave8,slave9,slave10,slave
11,slave12,slave13,slave14,slave15,slave16,slave17,slave18,slave19,slave20,slave21,s
lave22,slave23,slave24,slave25,slave26,slave27,slave28,slave29,slave30,slave31,slave
32,slave33,slave34,slave35,slave36,slave37,slave38,slave39,slave40,slave41,slave42,s
lave43,slave44,slave45,slave46,slave47,slave48,slave49,slave50,slave51,slave52,slave
53,slave54,slave55,slave56,slave57,slave58,slave59,slave60,slave61,slave62,slave63,s
lave64,slave65,slave66,slave67,slave68,slave69,slave70,slave71,slave72,slave73,slave
74,slave75,slave76,slave77,slave78,slave79,slave80,slave81)

javaparms="-Xms1280m -Xmx1280m -Xss96k -Xgcpolicy:optavgpause"
sd=default,size=687194767360
#sd=default,size=343597383680
sd=asu1_1,lun=/dev/rmap1
sd=asu1_2,lun=/dev/rmap2
sd=asu1_3,lun=/dev/rmap3
sd=asu1_4,lun=/dev/rmap4
sd=asu1_5,lun=/dev/rmap5
sd=asu1_6,lun=/dev/rmap6
sd=asu1_7,lun=/dev/rmap7
sd=asu1_8,lun=/dev/rmap8
sd=asu1_9,lun=/dev/rmap9
sd=asu1_10,lun=/dev/rmap10
sd=asu1_11,lun=/dev/rmap11
sd=asu1_12,lun=/dev/rmap12
sd=asu1_13,lun=/dev/rmap13
sd=asu1_14,lun=/dev/rmap14
sd=asu1_15,lun=/dev/rmap15
sd=asu1_16,lun=/dev/rmap16
sd=asu1_17,lun=/dev/rmap17
sd=asu1_18,lun=/dev/rmap18
sd=asu1_19,lun=/dev/rmap19
sd=asu1_20,lun=/dev/rmap20
sd=asu1_21,lun=/dev/rmap21
sd=asu1_22,lun=/dev/rmap22
```

sd=asu1\_23, lun=/dev/rmap23  
sd=asu1\_24, lun=/dev/rmap24  
sd=asu1\_25, lun=/dev/rmap25  
sd=asu1\_26, lun=/dev/rmap26  
sd=asu1\_27, lun=/dev/rmap27  
sd=asu1\_28, lun=/dev/rmap28  
sd=asu1\_29, lun=/dev/rmap29  
sd=asu1\_30, lun=/dev/rmap30  
sd=asu1\_31, lun=/dev/rmap31  
sd=asu1\_32, lun=/dev/rmap32  
sd=asu1\_33, lun=/dev/rmap33  
sd=asu1\_34, lun=/dev/rmap34  
sd=asu1\_35, lun=/dev/rmap35  
sd=asu1\_36, lun=/dev/rmap36  
sd=asu1\_37, lun=/dev/rmap37  
sd=asu1\_38, lun=/dev/rmap38  
sd=asu1\_39, lun=/dev/rmap39  
sd=asu1\_40, lun=/dev/rmap40  
sd=asu1\_41, lun=/dev/rmap41  
sd=asu1\_42, lun=/dev/rmap42  
sd=asu1\_43, lun=/dev/rmap43  
sd=asu1\_44, lun=/dev/rmap44  
sd=asu1\_45, lun=/dev/rmap45  
sd=asu1\_46, lun=/dev/rmap46  
sd=asu1\_47, lun=/dev/rmap47  
sd=asu1\_48, lun=/dev/rmap48  
sd=asu1\_49, lun=/dev/rmap49  
sd=asu1\_50, lun=/dev/rmap50  
sd=asu1\_51, lun=/dev/rmap51  
sd=asu1\_52, lun=/dev/rmap52  
sd=asu1\_53, lun=/dev/rmap53  
sd=asu1\_54, lun=/dev/rmap54  
sd=asu1\_55, lun=/dev/rmap55  
sd=asu1\_56, lun=/dev/rmap56  
sd=asu1\_57, lun=/dev/rmap57  
sd=asu1\_58, lun=/dev/rmap58  
sd=asu1\_59, lun=/dev/rmap59  
sd=asu1\_60, lun=/dev/rmap60  
sd=asu1\_61, lun=/dev/rmap61  
sd=asu1\_62, lun=/dev/rmap62  
sd=asu1\_63, lun=/dev/rmap63  
sd=asu1\_64, lun=/dev/rmap64  
sd=asu2\_1, lun=/dev/rmap65  
sd=asu2\_2, lun=/dev/rmap66  
sd=asu2\_3, lun=/dev/rmap67  
sd=asu2\_4, lun=/dev/rmap68  
sd=asu2\_5, lun=/dev/rmap69  
sd=asu2\_6, lun=/dev/rmap70  
sd=asu2\_7, lun=/dev/rmap71  
sd=asu2\_8, lun=/dev/rmap72  
sd=asu2\_9, lun=/dev/rmap73  
sd=asu2\_10, lun=/dev/rmap74  
sd=asu2\_11, lun=/dev/rmap75  
sd=asu2\_12, lun=/dev/rmap76  
sd=asu2\_13, lun=/dev/rmap77  
sd=asu2\_14, lun=/dev/rmap78  
sd=asu2\_15, lun=/dev/rmap79  
sd=asu2\_16, lun=/dev/rmap80  
sd=asu2\_17, lun=/dev/rmap81  
sd=asu2\_18, lun=/dev/rmap82  
sd=asu2\_19, lun=/dev/rmap83  
sd=asu2\_20, lun=/dev/rmap84  
sd=asu2\_21, lun=/dev/rmap85



```
sd=asu2_22,lun=/dev/rmap86
sd=asu2_23,lun=/dev/rmap87
sd=asu2_24,lun=/dev/rmap88
sd=asu2_25,lun=/dev/rmap89
sd=asu2_26,lun=/dev/rmap90
sd=asu2_27,lun=/dev/rmap91
sd=asu2_28,lun=/dev/rmap92
sd=asu2_29,lun=/dev/rmap93
sd=asu2_30,lun=/dev/rmap94
sd=asu2_31,lun=/dev/rmap95
sd=asu2_32,lun=/dev/rmap96
sd=asu2_33,lun=/dev/rmap97
sd=asu2_34,lun=/dev/rmap98
sd=asu2_35,lun=/dev/rmap99
sd=asu2_36,lun=/dev/rmap100
sd=asu2_37,lun=/dev/rmap101
sd=asu2_38,lun=/dev/rmap102
sd=asu2_39,lun=/dev/rmap103
sd=asu2_40,lun=/dev/rmap104
sd=asu2_41,lun=/dev/rmap105
sd=asu2_42,lun=/dev/rmap106
sd=asu2_43,lun=/dev/rmap107
sd=asu2_44,lun=/dev/rmap108
sd=asu2_45,lun=/dev/rmap109
sd=asu2_46,lun=/dev/rmap110
sd=asu2_47,lun=/dev/rmap111
sd=asu2_48,lun=/dev/rmap112
sd=asu2_49,lun=/dev/rmap113
sd=asu2_50,lun=/dev/rmap114
sd=asu2_51,lun=/dev/rmap115
sd=asu2_52,lun=/dev/rmap116
sd=asu2_53,lun=/dev/rmap117
sd=asu2_54,lun=/dev/rmap118
sd=asu2_55,lun=/dev/rmap119
sd=asu2_56,lun=/dev/rmap120
sd=asu2_57,lun=/dev/rmap121
sd=asu2_58,lun=/dev/rmap122
sd=asu2_59,lun=/dev/rmap123
sd=asu2_60,lun=/dev/rmap124
sd=asu2_61,lun=/dev/rmap125
sd=asu2_62,lun=/dev/rmap126
sd=asu2_63,lun=/dev/rmap127
sd=asu2_64,lun=/dev/rmap128
sd=asu3_1,lun=/dev/rmap129
sd=asu3_2,lun=/dev/rmap130
sd=asu3_3,lun=/dev/rmap131
sd=asu3_4,lun=/dev/rmap132
sd=asu3_5,lun=/dev/rmap133
sd=asu3_6,lun=/dev/rmap134
sd=asu3_7,lun=/dev/rmap135
sd=asu3_8,lun=/dev/rmap136
sd=asu3_9,lun=/dev/rmap137
sd=asu3_10,lun=/dev/rmap138
sd=asu3_11,lun=/dev/rmap139
sd=asu3_12,lun=/dev/rmap140
sd=asu3_13,lun=/dev/rmap141
sd=asu3_14,lun=/dev/rmap142
rd=ramp_10,bsus=761,startup=180,elapsed=600,interval=60
```

## Repeatability Test

### Repeat1 LRT Test Run

### Repeat1 IOPS Test Run

```
host=master
slaves=(slave1,slave2,slave3,slave4,slave5,slave6,slave7,slave8,slave9,slave10,slave
11,slave12,slave13,slave14,slave15,slave16,slave17,slave18,slave19,slave20,slave21,s
lave22,slave23,slave24,slave25,slave26,slave27,slave28,slave29,slave30,slave31,slave
32,slave33,slave34,slave35,slave36,slave37,slave38,slave39,slave40,slave41,slave42,s
lave43,slave44,slave45,slave46,slave47,slave48,slave49,slave50,slave51,slave52,slave
53,slave54,slave55,slave56,slave57,slave58,slave59,slave60,slave61,slave62,slave63,s
lave64,slave65,slave66,slave67,slave68,slave69,slave70,slave71,slave72,slave73,slave
74,slave75,slave76,slave77,slave78,slave79,slave80,slave81)
```

```
javaparms="-Xms1280m -Xmx1280m -Xss96k -Xgcpolicy:optavgpause"
sd=default,size=687194767360
#sd=default,size=343597383680
sd=asul_1,lun=/dev/rmap1
sd=asul_2,lun=/dev/rmap2
sd=asul_3,lun=/dev/rmap3
sd=asul_4,lun=/dev/rmap4
sd=asul_5,lun=/dev/rmap5
sd=asul_6,lun=/dev/rmap6
sd=asul_7,lun=/dev/rmap7
sd=asul_8,lun=/dev/rmap8
sd=asul_9,lun=/dev/rmap9
sd=asul_10,lun=/dev/rmap10
sd=asul_11,lun=/dev/rmap11
sd=asul_12,lun=/dev/rmap12
sd=asul_13,lun=/dev/rmap13
sd=asul_14,lun=/dev/rmap14
sd=asul_15,lun=/dev/rmap15
sd=asul_16,lun=/dev/rmap16
sd=asul_17,lun=/dev/rmap17
sd=asul_18,lun=/dev/rmap18
sd=asul_19,lun=/dev/rmap19
sd=asul_20,lun=/dev/rmap20
sd=asul_21,lun=/dev/rmap21
sd=asul_22,lun=/dev/rmap22
sd=asul_23,lun=/dev/rmap23
sd=asul_24,lun=/dev/rmap24
sd=asul_25,lun=/dev/rmap25
sd=asul_26,lun=/dev/rmap26
sd=asul_27,lun=/dev/rmap27
sd=asul_28,lun=/dev/rmap28
sd=asul_29,lun=/dev/rmap29
sd=asul_30,lun=/dev/rmap30
sd=asul_31,lun=/dev/rmap31
sd=asul_32,lun=/dev/rmap32
sd=asul_33,lun=/dev/rmap33
sd=asul_34,lun=/dev/rmap34
sd=asul_35,lun=/dev/rmap35
sd=asul_36,lun=/dev/rmap36
sd=asul_37,lun=/dev/rmap37
sd=asul_38,lun=/dev/rmap38
sd=asul_39,lun=/dev/rmap39
sd=asul_40,lun=/dev/rmap40
sd=asul_41,lun=/dev/rmap41
sd=asul_42,lun=/dev/rmap42
sd=asul_43,lun=/dev/rmap43
sd=asul_44,lun=/dev/rmap44
```

sd=asu1\_45, lun=/dev/rmap45  
sd=asu1\_46, lun=/dev/rmap46  
sd=asu1\_47, lun=/dev/rmap47  
sd=asu1\_48, lun=/dev/rmap48  
sd=asu1\_49, lun=/dev/rmap49  
sd=asu1\_50, lun=/dev/rmap50  
sd=asu1\_51, lun=/dev/rmap51  
sd=asu1\_52, lun=/dev/rmap52  
sd=asu1\_53, lun=/dev/rmap53  
sd=asu1\_54, lun=/dev/rmap54  
sd=asu1\_55, lun=/dev/rmap55  
sd=asu1\_56, lun=/dev/rmap56  
sd=asu1\_57, lun=/dev/rmap57  
sd=asu1\_58, lun=/dev/rmap58  
sd=asu1\_59, lun=/dev/rmap59  
sd=asu1\_60, lun=/dev/rmap60  
sd=asu1\_61, lun=/dev/rmap61  
sd=asu1\_62, lun=/dev/rmap62  
sd=asu1\_63, lun=/dev/rmap63  
sd=asu1\_64, lun=/dev/rmap64  
sd=asu2\_1, lun=/dev/rmap65  
sd=asu2\_2, lun=/dev/rmap66  
sd=asu2\_3, lun=/dev/rmap67  
sd=asu2\_4, lun=/dev/rmap68  
sd=asu2\_5, lun=/dev/rmap69  
sd=asu2\_6, lun=/dev/rmap70  
sd=asu2\_7, lun=/dev/rmap71  
sd=asu2\_8, lun=/dev/rmap72  
sd=asu2\_9, lun=/dev/rmap73  
sd=asu2\_10, lun=/dev/rmap74  
sd=asu2\_11, lun=/dev/rmap75  
sd=asu2\_12, lun=/dev/rmap76  
sd=asu2\_13, lun=/dev/rmap77  
sd=asu2\_14, lun=/dev/rmap78  
sd=asu2\_15, lun=/dev/rmap79  
sd=asu2\_16, lun=/dev/rmap80  
sd=asu2\_17, lun=/dev/rmap81  
sd=asu2\_18, lun=/dev/rmap82  
sd=asu2\_19, lun=/dev/rmap83  
sd=asu2\_20, lun=/dev/rmap84  
sd=asu2\_21, lun=/dev/rmap85  
sd=asu2\_22, lun=/dev/rmap86  
sd=asu2\_23, lun=/dev/rmap87  
sd=asu2\_24, lun=/dev/rmap88  
sd=asu2\_25, lun=/dev/rmap89  
sd=asu2\_26, lun=/dev/rmap90  
sd=asu2\_27, lun=/dev/rmap91  
sd=asu2\_28, lun=/dev/rmap92  
sd=asu2\_29, lun=/dev/rmap93  
sd=asu2\_30, lun=/dev/rmap94  
sd=asu2\_31, lun=/dev/rmap95  
sd=asu2\_32, lun=/dev/rmap96  
sd=asu2\_33, lun=/dev/rmap97  
sd=asu2\_34, lun=/dev/rmap98  
sd=asu2\_35, lun=/dev/rmap99  
sd=asu2\_36, lun=/dev/rmap100  
sd=asu2\_37, lun=/dev/rmap101  
sd=asu2\_38, lun=/dev/rmap102  
sd=asu2\_39, lun=/dev/rmap103  
sd=asu2\_40, lun=/dev/rmap104  
sd=asu2\_41, lun=/dev/rmap105  
sd=asu2\_42, lun=/dev/rmap106  
sd=asu2\_43, lun=/dev/rmap107

```
sd=asu2_44,lun=/dev/rmap108
sd=asu2_45,lun=/dev/rmap109
sd=asu2_46,lun=/dev/rmap110
sd=asu2_47,lun=/dev/rmap111
sd=asu2_48,lun=/dev/rmap112
sd=asu2_49,lun=/dev/rmap113
sd=asu2_50,lun=/dev/rmap114
sd=asu2_51,lun=/dev/rmap115
sd=asu2_52,lun=/dev/rmap116
sd=asu2_53,lun=/dev/rmap117
sd=asu2_54,lun=/dev/rmap118
sd=asu2_55,lun=/dev/rmap119
sd=asu2_56,lun=/dev/rmap120
sd=asu2_57,lun=/dev/rmap121
sd=asu2_58,lun=/dev/rmap122
sd=asu2_59,lun=/dev/rmap123
sd=asu2_60,lun=/dev/rmap124
sd=asu2_61,lun=/dev/rmap125
sd=asu2_62,lun=/dev/rmap126
sd=asu2_63,lun=/dev/rmap127
sd=asu2_64,lun=/dev/rmap128
sd=asu3_1,lun=/dev/rmap129
sd=asu3_2,lun=/dev/rmap130
sd=asu3_3,lun=/dev/rmap131
sd=asu3_4,lun=/dev/rmap132
sd=asu3_5,lun=/dev/rmap133
sd=asu3_6,lun=/dev/rmap134
sd=asu3_7,lun=/dev/rmap135
sd=asu3_8,lun=/dev/rmap136
sd=asu3_9,lun=/dev/rmap137
sd=asu3_10,lun=/dev/rmap138
sd=asu3_11,lun=/dev/rmap139
sd=asu3_12,lun=/dev/rmap140
sd=asu3_13,lun=/dev/rmap141
sd=asu3_14,lun=/dev/rmap142
rd=repeat1_lrt,bsus=761,startup=180,elapsed=600,interval=60
rd=repeat1_iops,bsus=7610,startup=180,elapsed=600,interval=60
```

## Repeat2 LRT Test Run Repeat2 IOS Test Run

```
host=master
slaves=(slave1,slave2,slave3,slave4,slave5,slave6,slave7,slave8,slave9,slave10,slave
11,slave12,slave13,slave14,slave15,slave16,slave17,slave18,slave19,slave20,slave21,s
lave22,slave23,slave24,slave25,slave26,slave27,slave28,slave29,slave30,slave31,slave
32,slave33,slave34,slave35,slave36,slave37,slave38,slave39,slave40,slave41,slave42,s
lave43,slave44,slave45,slave46,slave47,slave48,slave49,slave50,slave51,slave52,slave
53,slave54,slave55,slave56,slave57,slave58,slave59,slave60,slave61,slave62,slave63,s
lave64,slave65,slave66,slave67,slave68,slave69,slave70,slave71,slave72,slave73,slave
74,slave75,slave76,slave77,slave78,slave79,slave80,slave81)

javaparms="-Xms1280m -Xmx1280m -Xss96k -Xgcpolicy:optavgpause"
sd=default,size=687194767360
#sd=default,size=343597383680
sd=asu1_1,lun=/dev/rmap1
sd=asu1_2,lun=/dev/rmap2
sd=asu1_3,lun=/dev/rmap3
sd=asu1_4,lun=/dev/rmap4
sd=asu1_5,lun=/dev/rmap5
sd=asu1_6,lun=/dev/rmap6
```

sd=asul\_7,lun=/dev/rmap7  
sd=asul\_8,lun=/dev/rmap8  
sd=asul\_9,lun=/dev/rmap9  
sd=asul\_10,lun=/dev/rmap10  
sd=asul\_11,lun=/dev/rmap11  
sd=asul\_12,lun=/dev/rmap12  
sd=asul\_13,lun=/dev/rmap13  
sd=asul\_14,lun=/dev/rmap14  
sd=asul\_15,lun=/dev/rmap15  
sd=asul\_16,lun=/dev/rmap16  
sd=asul\_17,lun=/dev/rmap17  
sd=asul\_18,lun=/dev/rmap18  
sd=asul\_19,lun=/dev/rmap19  
sd=asul\_20,lun=/dev/rmap20  
sd=asul\_21,lun=/dev/rmap21  
sd=asul\_22,lun=/dev/rmap22  
sd=asul\_23,lun=/dev/rmap23  
sd=asul\_24,lun=/dev/rmap24  
sd=asul\_25,lun=/dev/rmap25  
sd=asul\_26,lun=/dev/rmap26  
sd=asul\_27,lun=/dev/rmap27  
sd=asul\_28,lun=/dev/rmap28  
sd=asul\_29,lun=/dev/rmap29  
sd=asul\_30,lun=/dev/rmap30  
sd=asul\_31,lun=/dev/rmap31  
sd=asul\_32,lun=/dev/rmap32  
sd=asul\_33,lun=/dev/rmap33  
sd=asul\_34,lun=/dev/rmap34  
sd=asul\_35,lun=/dev/rmap35  
sd=asul\_36,lun=/dev/rmap36  
sd=asul\_37,lun=/dev/rmap37  
sd=asul\_38,lun=/dev/rmap38  
sd=asul\_39,lun=/dev/rmap39  
sd=asul\_40,lun=/dev/rmap40  
sd=asul\_41,lun=/dev/rmap41  
sd=asul\_42,lun=/dev/rmap42  
sd=asul\_43,lun=/dev/rmap43  
sd=asul\_44,lun=/dev/rmap44  
sd=asul\_45,lun=/dev/rmap45  
sd=asul\_46,lun=/dev/rmap46  
sd=asul\_47,lun=/dev/rmap47  
sd=asul\_48,lun=/dev/rmap48  
sd=asul\_49,lun=/dev/rmap49  
sd=asul\_50,lun=/dev/rmap50  
sd=asul\_51,lun=/dev/rmap51  
sd=asul\_52,lun=/dev/rmap52  
sd=asul\_53,lun=/dev/rmap53  
sd=asul\_54,lun=/dev/rmap54  
sd=asul\_55,lun=/dev/rmap55  
sd=asul\_56,lun=/dev/rmap56  
sd=asul\_57,lun=/dev/rmap57  
sd=asul\_58,lun=/dev/rmap58  
sd=asul\_59,lun=/dev/rmap59  
sd=asul\_60,lun=/dev/rmap60  
sd=asul\_61,lun=/dev/rmap61  
sd=asul\_62,lun=/dev/rmap62  
sd=asul\_63,lun=/dev/rmap63  
sd=asul\_64,lun=/dev/rmap64  
sd=asu2\_1,lun=/dev/rmap65  
sd=asu2\_2,lun=/dev/rmap66  
sd=asu2\_3,lun=/dev/rmap67  
sd=asu2\_4,lun=/dev/rmap68  
sd=asu2\_5,lun=/dev/rmap69

sd=asu2\_6,lun=/dev/rmap70  
sd=asu2\_7,lun=/dev/rmap71  
sd=asu2\_8,lun=/dev/rmap72  
sd=asu2\_9,lun=/dev/rmap73  
sd=asu2\_10,lun=/dev/rmap74  
sd=asu2\_11,lun=/dev/rmap75  
sd=asu2\_12,lun=/dev/rmap76  
sd=asu2\_13,lun=/dev/rmap77  
sd=asu2\_14,lun=/dev/rmap78  
sd=asu2\_15,lun=/dev/rmap79  
sd=asu2\_16,lun=/dev/rmap80  
sd=asu2\_17,lun=/dev/rmap81  
sd=asu2\_18,lun=/dev/rmap82  
sd=asu2\_19,lun=/dev/rmap83  
sd=asu2\_20,lun=/dev/rmap84  
sd=asu2\_21,lun=/dev/rmap85  
sd=asu2\_22,lun=/dev/rmap86  
sd=asu2\_23,lun=/dev/rmap87  
sd=asu2\_24,lun=/dev/rmap88  
sd=asu2\_25,lun=/dev/rmap89  
sd=asu2\_26,lun=/dev/rmap90  
sd=asu2\_27,lun=/dev/rmap91  
sd=asu2\_28,lun=/dev/rmap92  
sd=asu2\_29,lun=/dev/rmap93  
sd=asu2\_30,lun=/dev/rmap94  
sd=asu2\_31,lun=/dev/rmap95  
sd=asu2\_32,lun=/dev/rmap96  
sd=asu2\_33,lun=/dev/rmap97  
sd=asu2\_34,lun=/dev/rmap98  
sd=asu2\_35,lun=/dev/rmap99  
sd=asu2\_36,lun=/dev/rmap100  
sd=asu2\_37,lun=/dev/rmap101  
sd=asu2\_38,lun=/dev/rmap102  
sd=asu2\_39,lun=/dev/rmap103  
sd=asu2\_40,lun=/dev/rmap104  
sd=asu2\_41,lun=/dev/rmap105  
sd=asu2\_42,lun=/dev/rmap106  
sd=asu2\_43,lun=/dev/rmap107  
sd=asu2\_44,lun=/dev/rmap108  
sd=asu2\_45,lun=/dev/rmap109  
sd=asu2\_46,lun=/dev/rmap110  
sd=asu2\_47,lun=/dev/rmap111  
sd=asu2\_48,lun=/dev/rmap112  
sd=asu2\_49,lun=/dev/rmap113  
sd=asu2\_50,lun=/dev/rmap114  
sd=asu2\_51,lun=/dev/rmap115  
sd=asu2\_52,lun=/dev/rmap116  
sd=asu2\_53,lun=/dev/rmap117  
sd=asu2\_54,lun=/dev/rmap118  
sd=asu2\_55,lun=/dev/rmap119  
sd=asu2\_56,lun=/dev/rmap120  
sd=asu2\_57,lun=/dev/rmap121  
sd=asu2\_58,lun=/dev/rmap122  
sd=asu2\_59,lun=/dev/rmap123  
sd=asu2\_60,lun=/dev/rmap124  
sd=asu2\_61,lun=/dev/rmap125  
sd=asu2\_62,lun=/dev/rmap126  
sd=asu2\_63,lun=/dev/rmap127  
sd=asu2\_64,lun=/dev/rmap128  
sd=asu3\_1,lun=/dev/rmap129  
sd=asu3\_2,lun=/dev/rmap130  
sd=asu3\_3,lun=/dev/rmap131  
sd=asu3\_4,lun=/dev/rmap132

```
sd=asu3_5,lun=/dev/rmap133
sd=asu3_6,lun=/dev/rmap134
sd=asu3_7,lun=/dev/rmap135
sd=asu3_8,lun=/dev/rmap136
sd=asu3_9,lun=/dev/rmap137
sd=asu3_10,lun=/dev/rmap138
sd=asu3_11,lun=/dev/rmap139
sd=asu3_12,lun=/dev/rmap140
sd=asu3_13,lun=/dev/rmap141
sd=asu3_14,lun=/dev/rmap142
rd=repeat2_lrt,bsus=761,startup=180,elapsed=600,interval=60
rd=repeat2_iops,bsus=7610,startup=180,elapsed=600,interval=60
```

## Persistence Test

### Persistence Test Run 1

```
* Persistence Test Run 1
host=localhost,jvms=8,maxstreams=200

sd=default,host=localhost,size=687194767360
sd=sd1,lun=/dev/rmap1
sd=sd2,lun=/dev/rmap2
sd=sd3,lun=/dev/rmap3
sd=sd4,lun=/dev/rmap4
sd=sd5,lun=/dev/rmap5
sd=sd6,lun=/dev/rmap6
sd=sd7,lun=/dev/rmap7
sd=sd8,lun=/dev/rmap8
sd=sd9,lun=/dev/rmap9
sd=sd10,lun=/dev/rmap10
sd=sd11,lun=/dev/rmap11
sd=sd12,lun=/dev/rmap12
sd=sd13,lun=/dev/rmap13
sd=sd14,lun=/dev/rmap14
sd=sd15,lun=/dev/rmap15
sd=sd16,lun=/dev/rmap16
sd=sd17,lun=/dev/rmap17
sd=sd18,lun=/dev/rmap18
sd=sd19,lun=/dev/rmap19
sd=sd20,lun=/dev/rmap20
sd=sd21,lun=/dev/rmap21
sd=sd22,lun=/dev/rmap22
sd=sd23,lun=/dev/rmap23
sd=sd24,lun=/dev/rmap24
sd=sd25,lun=/dev/rmap25
sd=sd26,lun=/dev/rmap26
sd=sd27,lun=/dev/rmap27
sd=sd28,lun=/dev/rmap28
sd=sd29,lun=/dev/rmap29
sd=sd30,lun=/dev/rmap30
sd=sd31,lun=/dev/rmap31
sd=sd32,lun=/dev/rmap32
sd=sd33,lun=/dev/rmap33
sd=sd34,lun=/dev/rmap34
sd=sd35,lun=/dev/rmap35
sd=sd36,lun=/dev/rmap36
sd=sd37,lun=/dev/rmap37
sd=sd38,lun=/dev/rmap38
```

sd=sd39,lun=/dev/rmap39  
sd=sd40,lun=/dev/rmap40  
sd=sd41,lun=/dev/rmap41  
sd=sd42,lun=/dev/rmap42  
sd=sd43,lun=/dev/rmap43  
sd=sd44,lun=/dev/rmap44  
sd=sd45,lun=/dev/rmap45  
sd=sd46,lun=/dev/rmap46  
sd=sd47,lun=/dev/rmap47  
sd=sd48,lun=/dev/rmap48  
sd=sd49,lun=/dev/rmap49  
sd=sd50,lun=/dev/rmap50  
sd=sd51,lun=/dev/rmap51  
sd=sd52,lun=/dev/rmap52  
sd=sd53,lun=/dev/rmap53  
sd=sd54,lun=/dev/rmap54  
sd=sd55,lun=/dev/rmap55  
sd=sd56,lun=/dev/rmap56  
sd=sd57,lun=/dev/rmap57  
sd=sd58,lun=/dev/rmap58  
sd=sd59,lun=/dev/rmap59  
sd=sd60,lun=/dev/rmap60  
sd=sd61,lun=/dev/rmap61  
sd=sd62,lun=/dev/rmap62  
sd=sd63,lun=/dev/rmap63  
sd=sd64,lun=/dev/rmap64  
sd=sd65,lun=/dev/rmap65  
sd=sd66,lun=/dev/rmap66  
sd=sd67,lun=/dev/rmap67  
sd=sd68,lun=/dev/rmap68  
sd=sd69,lun=/dev/rmap69  
sd=sd70,lun=/dev/rmap70  
sd=sd71,lun=/dev/rmap71  
sd=sd72,lun=/dev/rmap72  
sd=sd73,lun=/dev/rmap73  
sd=sd74,lun=/dev/rmap74  
sd=sd75,lun=/dev/rmap75  
sd=sd76,lun=/dev/rmap76  
sd=sd77,lun=/dev/rmap77  
sd=sd78,lun=/dev/rmap78  
sd=sd79,lun=/dev/rmap79  
sd=sd80,lun=/dev/rmap80  
sd=sd81,lun=/dev/rmap81  
sd=sd82,lun=/dev/rmap82  
sd=sd83,lun=/dev/rmap83  
sd=sd84,lun=/dev/rmap84  
sd=sd85,lun=/dev/rmap85  
sd=sd86,lun=/dev/rmap86  
sd=sd87,lun=/dev/rmap87  
sd=sd88,lun=/dev/rmap88  
sd=sd89,lun=/dev/rmap89  
sd=sd90,lun=/dev/rmap90  
sd=sd91,lun=/dev/rmap91  
sd=sd92,lun=/dev/rmap92  
sd=sd93,lun=/dev/rmap93  
sd=sd94,lun=/dev/rmap94  
sd=sd95,lun=/dev/rmap95  
sd=sd96,lun=/dev/rmap96  
sd=sd97,lun=/dev/rmap97  
sd=sd98,lun=/dev/rmap98  
sd=sd99,lun=/dev/rmap99  
sd=sd100,lun=/dev/rmap100  
sd=sd101,lun=/dev/rmap101



```
sd=sd102,lun=/dev/rmap102
sd=sd103,lun=/dev/rmap103
sd=sd104,lun=/dev/rmap104
sd=sd105,lun=/dev/rmap105
sd=sd106,lun=/dev/rmap106
sd=sd107,lun=/dev/rmap107
sd=sd108,lun=/dev/rmap108
sd=sd109,lun=/dev/rmap109
sd=sd110,lun=/dev/rmap110
sd=sd111,lun=/dev/rmap111
sd=sd112,lun=/dev/rmap112
sd=sd113,lun=/dev/rmap113
sd=sd114,lun=/dev/rmap114
sd=sd115,lun=/dev/rmap115
sd=sd116,lun=/dev/rmap116
sd=sd117,lun=/dev/rmap117
sd=sd118,lun=/dev/rmap118
sd=sd119,lun=/dev/rmap119
sd=sd120,lun=/dev/rmap120
sd=sd121,lun=/dev/rmap121
sd=sd122,lun=/dev/rmap122
sd=sd123,lun=/dev/rmap123
sd=sd124,lun=/dev/rmap124
sd=sd125,lun=/dev/rmap125
sd=sd126,lun=/dev/rmap126
sd=sd127,lun=/dev/rmap127
sd=sd128,lun=/dev/rmap128
sd=sd129,lun=/dev/rmap129
sd=sd130,lun=/dev/rmap130
sd=sd131,lun=/dev/rmap131
sd=sd132,lun=/dev/rmap132
sd=sd133,lun=/dev/rmap133
sd=sd134,lun=/dev/rmap134
sd=sd135,lun=/dev/rmap135
sd=sd136,lun=/dev/rmap136
sd=sd137,lun=/dev/rmap137
sd=sd138,lun=/dev/rmap138
sd=sd139,lun=/dev/rmap139
sd=sd140,lun=/dev/rmap140
sd=sd141,lun=/dev/rmap141
sd=sd142,lun=/dev/rmap142
maxlatestart=1
reportinginterval=5
segmentlength=512m

rd=default,rampup=180,periods=90,measurement=300,runout=0,rampdown=0,buffers=1

rd=default,rdpct=0,xfersize=1024k
rd=TR1-5s_SPC-2-persist-w,streams=284
```

## Persistence Test Run 2

```
* Persistence Test Run 2

host=localhost,jvms=8,maxstreams=200

sd=default,host=localhost,size=687194767360
sd=sd1,lun=/dev/rmap1
sd=sd2,lun=/dev/rmap2
sd=sd3,lun=/dev/rmap3
sd=sd4,lun=/dev/rmap4
sd=sd5,lun=/dev/rmap5
```

sd=sd6 , lun=/dev/rmap6  
sd=sd7 , lun=/dev/rmap7  
sd=sd8 , lun=/dev/rmap8  
sd=sd9 , lun=/dev/rmap9  
sd=sd10 , lun=/dev/rmap10  
sd=sd11 , lun=/dev/rmap11  
sd=sd12 , lun=/dev/rmap12  
sd=sd13 , lun=/dev/rmap13  
sd=sd14 , lun=/dev/rmap14  
sd=sd15 , lun=/dev/rmap15  
sd=sd16 , lun=/dev/rmap16  
sd=sd17 , lun=/dev/rmap17  
sd=sd18 , lun=/dev/rmap18  
sd=sd19 , lun=/dev/rmap19  
sd=sd20 , lun=/dev/rmap20  
sd=sd21 , lun=/dev/rmap21  
sd=sd22 , lun=/dev/rmap22  
sd=sd23 , lun=/dev/rmap23  
sd=sd24 , lun=/dev/rmap24  
sd=sd25 , lun=/dev/rmap25  
sd=sd26 , lun=/dev/rmap26  
sd=sd27 , lun=/dev/rmap27  
sd=sd28 , lun=/dev/rmap28  
sd=sd29 , lun=/dev/rmap29  
sd=sd30 , lun=/dev/rmap30  
sd=sd31 , lun=/dev/rmap31  
sd=sd32 , lun=/dev/rmap32  
sd=sd33 , lun=/dev/rmap33  
sd=sd34 , lun=/dev/rmap34  
sd=sd35 , lun=/dev/rmap35  
sd=sd36 , lun=/dev/rmap36  
sd=sd37 , lun=/dev/rmap37  
sd=sd38 , lun=/dev/rmap38  
sd=sd39 , lun=/dev/rmap39  
sd=sd40 , lun=/dev/rmap40  
sd=sd41 , lun=/dev/rmap41  
sd=sd42 , lun=/dev/rmap42  
sd=sd43 , lun=/dev/rmap43  
sd=sd44 , lun=/dev/rmap44  
sd=sd45 , lun=/dev/rmap45  
sd=sd46 , lun=/dev/rmap46  
sd=sd47 , lun=/dev/rmap47  
sd=sd48 , lun=/dev/rmap48  
sd=sd49 , lun=/dev/rmap49  
sd=sd50 , lun=/dev/rmap50  
sd=sd51 , lun=/dev/rmap51  
sd=sd52 , lun=/dev/rmap52  
sd=sd53 , lun=/dev/rmap53  
sd=sd54 , lun=/dev/rmap54  
sd=sd55 , lun=/dev/rmap55  
sd=sd56 , lun=/dev/rmap56  
sd=sd57 , lun=/dev/rmap57  
sd=sd58 , lun=/dev/rmap58  
sd=sd59 , lun=/dev/rmap59  
sd=sd60 , lun=/dev/rmap60  
sd=sd61 , lun=/dev/rmap61  
sd=sd62 , lun=/dev/rmap62  
sd=sd63 , lun=/dev/rmap63  
sd=sd64 , lun=/dev/rmap64  
sd=sd65 , lun=/dev/rmap65  
sd=sd66 , lun=/dev/rmap66  
sd=sd67 , lun=/dev/rmap67  
sd=sd68 , lun=/dev/rmap68

sd=sd69,lun=/dev/rmap69  
sd=sd70,lun=/dev/rmap70  
sd=sd71,lun=/dev/rmap71  
sd=sd72,lun=/dev/rmap72  
sd=sd73,lun=/dev/rmap73  
sd=sd74,lun=/dev/rmap74  
sd=sd75,lun=/dev/rmap75  
sd=sd76,lun=/dev/rmap76  
sd=sd77,lun=/dev/rmap77  
sd=sd78,lun=/dev/rmap78  
sd=sd79,lun=/dev/rmap79  
sd=sd80,lun=/dev/rmap80  
sd=sd81,lun=/dev/rmap81  
sd=sd82,lun=/dev/rmap82  
sd=sd83,lun=/dev/rmap83  
sd=sd84,lun=/dev/rmap84  
sd=sd85,lun=/dev/rmap85  
sd=sd86,lun=/dev/rmap86  
sd=sd87,lun=/dev/rmap87  
sd=sd88,lun=/dev/rmap88  
sd=sd89,lun=/dev/rmap89  
sd=sd90,lun=/dev/rmap90  
sd=sd91,lun=/dev/rmap91  
sd=sd92,lun=/dev/rmap92  
sd=sd93,lun=/dev/rmap93  
sd=sd94,lun=/dev/rmap94  
sd=sd95,lun=/dev/rmap95  
sd=sd96,lun=/dev/rmap96  
sd=sd97,lun=/dev/rmap97  
sd=sd98,lun=/dev/rmap98  
sd=sd99,lun=/dev/rmap99  
sd=sd100,lun=/dev/rmap100  
sd=sd101,lun=/dev/rmap101  
sd=sd102,lun=/dev/rmap102  
sd=sd103,lun=/dev/rmap103  
sd=sd104,lun=/dev/rmap104  
sd=sd105,lun=/dev/rmap105  
sd=sd106,lun=/dev/rmap106  
sd=sd107,lun=/dev/rmap107  
sd=sd108,lun=/dev/rmap108  
sd=sd109,lun=/dev/rmap109  
sd=sd110,lun=/dev/rmap110  
sd=sd111,lun=/dev/rmap111  
sd=sd112,lun=/dev/rmap112  
sd=sd113,lun=/dev/rmap113  
sd=sd114,lun=/dev/rmap114  
sd=sd115,lun=/dev/rmap115  
sd=sd116,lun=/dev/rmap116  
sd=sd117,lun=/dev/rmap117  
sd=sd118,lun=/dev/rmap118  
sd=sd119,lun=/dev/rmap119  
sd=sd120,lun=/dev/rmap120  
sd=sd121,lun=/dev/rmap121  
sd=sd122,lun=/dev/rmap122  
sd=sd123,lun=/dev/rmap123  
sd=sd124,lun=/dev/rmap124  
sd=sd125,lun=/dev/rmap125  
sd=sd126,lun=/dev/rmap126  
sd=sd127,lun=/dev/rmap127  
sd=sd128,lun=/dev/rmap128  
sd=sd129,lun=/dev/rmap129  
sd=sd130,lun=/dev/rmap130  
sd=sd131,lun=/dev/rmap131

```
sd=sd132,lun=/dev/rmap132
sd=sd133,lun=/dev/rmap133
sd=sd134,lun=/dev/rmap134
sd=sd135,lun=/dev/rmap135
sd=sd136,lun=/dev/rmap136
sd=sd137,lun=/dev/rmap137
sd=sd138,lun=/dev/rmap138
sd=sd139,lun=/dev/rmap139
sd=sd140,lun=/dev/rmap140
sd=sd141,lun=/dev/rmap141
sd=sd142,lun=/dev/rmap142
maxlatestart=1
reportinginterval=5
segmentlength=512m

maxpersistenceerrors=10
*corruptstreams=3

rd=default,buffers=1,rdpct=100,xfersize=1024k
rd=TR1-5s_SPC-2-persist-r
```

## **APPENDIX E: SPC-1 WORKLOAD GENERATOR INPUT PARAMETERS**

### **Primary Metrics Test, Repeatability Test, and Persistence Test Run 1**

The following script was used to execute the Primary Metrics Test (*Sustainability Test Phase, IOPS Test Phase, and Response Time Ramp Test Phase*), Repeatability Test (*Repeatability Test Phase 1 and Repeatability Test Phase 2*), and Persistence Test Run 1 in an uninterrupted sequence.

The Slave JVMs were started prior to each Test Run and terminated at the completion of each Test Run to address a Java memory allocation issue.

```
export PATH=$PATH:/usr/java5/bin
export SPC1HOME=/perform/spc1install
export CLASSPATH=$SPC1HOME
export LIBPATH=$SPC1HOME/aix
export IBM_JAVADUMP_OUTOFMEMORY=false
export IBM_HEAPDUMP_OUTOFMEMORY=false

runslaves.sh
java -Xoptionsfile=javaopts.cfg spc1 -fmetrics1.txt -ometrics1 SPCOut
rmslaves.sh 1 81

runslaves.sh
java -Xoptionsfile=javaopts.cfg spc1 -fmetrics2.txt -ometrics2 SPCOut
rmslaves.sh 1 81

runslaves.sh
java -Xoptionsfile=javaopts.cfg spc1 -fmetrics3.txt -ometrics3 SPCOut
rmslaves.sh 1 81

runslaves.sh
java -Xoptionsfile=javaopts.cfg spc1 -fmetrics4.txt -ometrics4 SPCOut
rmslaves.sh 1 81

runslaves.sh
java -Xoptionsfile=javaopts.cfg spc1 -fmetrics5.txt -ometrics5 SPCOut
rmslaves.sh 1 81

runslaves.sh
java -Xoptionsfile=javaopts.cfg spc1 -fmetrics6.txt -ometrics6 SPCOut
rmslaves.sh 1 81

runslaves.sh
java -Xoptionsfile=javaopts.cfg spc1 -fmetrics7.txt -ometrics7 SPCOut
rmslaves.sh 1 81

runslaves.sh
java -Xoptionsfile=javaopts.cfg spc1 -frepeat1.txt -orepeat1 SPCOut
rmslaves.sh 1 81

runslaves.sh
java -Xoptionsfile=javaopts.cfg spc1 -frepeat2.txt -orepeat2 SPCOut
rmslaves.sh 1 81

rmdir=`pwd`
cd /perform/spc2runs/persistrun
./runpersist1.sh
cd $rmdir
```

## runpersist1.sh

```
export PATH=$PATH:/usr/java5/bin
export SPC2HOME=/perform/spc2install
export CLASSPATH=$SPC2HOME
export LIBPATH=$SPC2HOME/aix
export IBM_JAVADUMP_OUTOFMEMORY=false
export IBM_HEAPDUMP_OUTOFMEMORY=false
java -Xoptionsfile=javaoptsp.cfg vdbench -f persistw.cfg -o persistw
```

## runslaves.sh

The following script starts all of the Slave JVMs

```
export PATH=$PATH:/usr/java5/bin
export SPC1HOME=/perform/spc1install
export CLASSPATH=$SPC1HOME
export LIBPATH=$SPC1HOME/aix
export IBM_JAVADUMP_OUTOFMEMORY=false
export IBM_HEAPDUMP_OUTOFMEMORY=false
nohup java -Xoptionsfile=javaopts.cfg spc1 -f slave1.txt > slave1.out&
nohup java -Xoptionsfile=javaopts.cfg spc1 -f slave2.txt > slave2.out&
nohup java -Xoptionsfile=javaopts.cfg spc1 -f slave3.txt > slave3.out&
nohup java -Xoptionsfile=javaopts.cfg spc1 -f slave4.txt > slave4.out&
nohup java -Xoptionsfile=javaopts.cfg spc1 -f slave5.txt > slave5.out&
nohup java -Xoptionsfile=javaopts.cfg spc1 -f slave6.txt > slave6.out&
nohup java -Xoptionsfile=javaopts.cfg spc1 -f slave7.txt > slave7.out&
nohup java -Xoptionsfile=javaopts.cfg spc1 -f slave8.txt > slave8.out&
nohup java -Xoptionsfile=javaopts.cfg spc1 -f slave9.txt > slave9.out&
nohup java -Xoptionsfile=javaopts.cfg spc1 -f slave10.txt > slave10.out&
nohup java -Xoptionsfile=javaopts.cfg spc1 -f slave11.txt > slave11.out&
nohup java -Xoptionsfile=javaopts.cfg spc1 -f slave12.txt > slave12.out&
nohup java -Xoptionsfile=javaopts.cfg spc1 -f slave13.txt > slave13.out&
nohup java -Xoptionsfile=javaopts.cfg spc1 -f slave14.txt > slave14.out&
nohup java -Xoptionsfile=javaopts.cfg spc1 -f slave15.txt > slave15.out&
nohup java -Xoptionsfile=javaopts.cfg spc1 -f slave16.txt > slave16.out&
nohup java -Xoptionsfile=javaopts.cfg spc1 -f slave17.txt > slave17.out&
nohup java -Xoptionsfile=javaopts.cfg spc1 -f slave18.txt > slave18.out&
nohup java -Xoptionsfile=javaopts.cfg spc1 -f slave19.txt > slave19.out&
nohup java -Xoptionsfile=javaopts.cfg spc1 -f slave20.txt > slave20.out&
nohup java -Xoptionsfile=javaopts.cfg spc1 -f slave21.txt > slave21.out&
nohup java -Xoptionsfile=javaopts.cfg spc1 -f slave22.txt > slave22.out&
nohup java -Xoptionsfile=javaopts.cfg spc1 -f slave23.txt > slave23.out&
nohup java -Xoptionsfile=javaopts.cfg spc1 -f slave24.txt > slave24.out&
nohup java -Xoptionsfile=javaopts.cfg spc1 -f slave25.txt > slave25.out&
nohup java -Xoptionsfile=javaopts.cfg spc1 -f slave26.txt > slave26.out&
nohup java -Xoptionsfile=javaopts.cfg spc1 -f slave27.txt > slave27.out&
nohup java -Xoptionsfile=javaopts.cfg spc1 -f slave28.txt > slave28.out&
nohup java -Xoptionsfile=javaopts.cfg spc1 -f slave29.txt > slave29.out&
nohup java -Xoptionsfile=javaopts.cfg spc1 -f slave30.txt > slave30.out&
nohup java -Xoptionsfile=javaopts.cfg spc1 -f slave31.txt > slave31.out&
nohup java -Xoptionsfile=javaopts.cfg spc1 -f slave32.txt > slave32.out&
nohup java -Xoptionsfile=javaopts.cfg spc1 -f slave33.txt > slave33.out&
nohup java -Xoptionsfile=javaopts.cfg spc1 -f slave34.txt > slave34.out&
nohup java -Xoptionsfile=javaopts.cfg spc1 -f slave35.txt > slave35.out&
nohup java -Xoptionsfile=javaopts.cfg spc1 -f slave36.txt > slave36.out&
nohup java -Xoptionsfile=javaopts.cfg spc1 -f slave37.txt > slave37.out&
nohup java -Xoptionsfile=javaopts.cfg spc1 -f slave38.txt > slave38.out&
nohup java -Xoptionsfile=javaopts.cfg spc1 -f slave39.txt > slave39.out&
nohup java -Xoptionsfile=javaopts.cfg spc1 -f slave40.txt > slave40.out&
nohup java -Xoptionsfile=javaopts.cfg spc1 -f slave41.txt > slave41.out&
nohup java -Xoptionsfile=javaopts.cfg spc1 -f slave42.txt > slave42.out&
```

```
nohup java -Xoptionsfile=javaopts.cfg spc1 -f slave43.txt > slave43.out&
nohup java -Xoptionsfile=javaopts.cfg spc1 -f slave44.txt > slave44.out&
nohup java -Xoptionsfile=javaopts.cfg spc1 -f slave45.txt > slave45.out&
nohup java -Xoptionsfile=javaopts.cfg spc1 -f slave46.txt > slave46.out&
nohup java -Xoptionsfile=javaopts.cfg spc1 -f slave47.txt > slave47.out&
nohup java -Xoptionsfile=javaopts.cfg spc1 -f slave48.txt > slave48.out&
nohup java -Xoptionsfile=javaopts.cfg spc1 -f slave49.txt > slave49.out&
nohup java -Xoptionsfile=javaopts.cfg spc1 -f slave50.txt > slave50.out&
nohup java -Xoptionsfile=javaopts.cfg spc1 -f slave51.txt > slave51.out&
nohup java -Xoptionsfile=javaopts.cfg spc1 -f slave52.txt > slave52.out&
nohup java -Xoptionsfile=javaopts.cfg spc1 -f slave53.txt > slave53.out&
nohup java -Xoptionsfile=javaopts.cfg spc1 -f slave54.txt > slave54.out&
nohup java -Xoptionsfile=javaopts.cfg spc1 -f slave55.txt > slave55.out&
nohup java -Xoptionsfile=javaopts.cfg spc1 -f slave56.txt > slave56.out&
nohup java -Xoptionsfile=javaopts.cfg spc1 -f slave57.txt > slave57.out&
nohup java -Xoptionsfile=javaopts.cfg spc1 -f slave58.txt > slave58.out&
nohup java -Xoptionsfile=javaopts.cfg spc1 -f slave59.txt > slave59.out&
nohup java -Xoptionsfile=javaopts.cfg spc1 -f slave60.txt > slave60.out&
nohup java -Xoptionsfile=javaopts.cfg spc1 -f slave61.txt > slave61.out&
nohup java -Xoptionsfile=javaopts.cfg spc1 -f slave62.txt > slave62.out&
nohup java -Xoptionsfile=javaopts.cfg spc1 -f slave63.txt > slave63.out&
nohup java -Xoptionsfile=javaopts.cfg spc1 -f slave64.txt > slave64.out&
nohup java -Xoptionsfile=javaopts.cfg spc1 -f slave65.txt > slave65.out&
nohup java -Xoptionsfile=javaopts.cfg spc1 -f slave66.txt > slave66.out&
nohup java -Xoptionsfile=javaopts.cfg spc1 -f slave67.txt > slave67.out&
nohup java -Xoptionsfile=javaopts.cfg spc1 -f slave68.txt > slave68.out&
nohup java -Xoptionsfile=javaopts.cfg spc1 -f slave69.txt > slave69.out&
nohup java -Xoptionsfile=javaopts.cfg spc1 -f slave70.txt > slave70.out&
nohup java -Xoptionsfile=javaopts.cfg spc1 -f slave71.txt > slave71.out&
nohup java -Xoptionsfile=javaopts.cfg spc1 -f slave72.txt > slave72.out&
nohup java -Xoptionsfile=javaopts.cfg spc1 -f slave73.txt > slave73.out&
nohup java -Xoptionsfile=javaopts.cfg spc1 -f slave74.txt > slave74.out&
nohup java -Xoptionsfile=javaopts.cfg spc1 -f slave75.txt > slave75.out&
nohup java -Xoptionsfile=javaopts.cfg spc1 -f slave76.txt > slave76.out&
nohup java -Xoptionsfile=javaopts.cfg spc1 -f slave77.txt > slave77.out&
nohup java -Xoptionsfile=javaopts.cfg spc1 -f slave78.txt > slave78.out&
nohup java -Xoptionsfile=javaopts.cfg spc1 -f slave79.txt > slave79.out&
nohup java -Xoptionsfile=javaopts.cfg spc1 -f slave80.txt > slave80.out&
nohup java -Xoptionsfile=javaopts.cfg spc1 -f slave81.txt > slave81.out&
```

## rmslaves.sh

The following script terminates all of the Slave JVMs

```
if [ $# -lt 2 ]
then
    echo "usage: rmslaves.sh first last"
    return
fi
i=$1
while [[ $i -le $2 ]]
do
    idline=`ps -af | grep slave$i | grep -v grep`
    if [ $? -eq 0 ]
    then
        id=`echo $idline | awk '{print $2}'`
        kill -kill $id
    fi
    let i="i+1"
done
```

## Persistence Test Run 2

The following script was used to execute Persistence Test Run 2.

### **runpersist2.sh**

```
export PATH=$PATH:/usr/java5/bin
export SPC2HOME=/perform/spc2install
export CLASSPATH=$SPC2HOME
export LIBPATH=$SPC2HOME/aix
export IBM_JAVADUMP_OUTOFMEMORY=false
export IBM_HEAPDUMP_OUTOFMEMORY=false
java -Xoptionsfile=javaoptsp.cfg vdbench -f persistr.cfg -o persistr
```