



SPC BENCHMARK 1™
FULL DISCLOSURE REPORT

IBM CORPORATION
IBM SYSTEM STORAGE DS3400

SPC-1 V1.10.1

Submitted for Review: February 27, 2008

Submission Identifier: A00061

Revised: March 4, 2008

First Edition – February 2008

THE INFORMATION CONTAINED IN THIS DOCUMENT IS DISTRIBUTED ON AN AS IS BASIS WITHOUT ANY WARRANTY EITHER EXPRESS OR IMPLIED. The use of this information or the implementation of any of these techniques is the customer's responsibility and depends on the customer's ability to evaluate and integrate them into the customer's operational environment. While each item has been reviewed by IBM Corporation for accuracy in a specific situation, there is no guarantee that the same or similar results will be obtained elsewhere. Customers attempting to adapt these techniques to their own environment do so at their own risk.

This publication was produced in the United States. IBM Corporation may not offer the products, services, or features discussed in this document in other countries, and the information is subject to change with notice. Consult your local IBM Corporation representative for information on products and services available in your area.

© Copyright IBM Corporation 2008. All rights reserved.

Permission is hereby granted to reproduce this document in whole or in part, provided the copyright notice as printed above is set forth in full text on the title page of each item reproduced.

Trademarks

SPC Benchmark-1, SPC-1, SPC-1 IOPS, and SPC-1 LRT are trademarks of the Storage Performance Council. IBM, the IBM logo, and System Storage are trademarks or registered trademarks of IBM Corporation in the United States and other countries. All other brands, trademarks, and product names are the property of their respective owners.

Table of Contents

Audit Certification	vii
Audit Certification (cont.)	viii
Letter of Good Faith	ix
Executive Summary	10
Test Sponsor and Contact Information	10
Revision Information and Key Dates	10
Tested Storage Product (TSP) Description	11
Summary of Results	12
Storage Capacities and Relationships	12
Response Time - Throughput Curve	13
Response Time - Throughput Data	13
Tested Storage Configuration Pricing (Priced Storage Configuration)	14
Differences between the Tested Storage Configuration (TSC) and Priced Storage Configuration	14
Benchmark Configuration/Tested Storage Configuration Diagram	15
Benchmark Configuration/Tested Storage Configuration Components	16
Configuration Information	17
Benchmark Configuration (BC)/Tested Storage Configuration (TSC) Diagram	17
Storage Network Configuration	17
Host System Configuration	17
Customer Tunable Parameters and Options	18
Tested Storage Configuration (TSC) Description	18
SPC-1 Workload Generator Storage Configuration	18
SPC-1 Data Repository	19
Storage Capacities and Relationships	19
SPC-1 Storage Capacities	19
SPC-1 Storage Hierarchy Ratios	19
SPC-1 Storage Capacities and Relationships Illustration	20
Logical Volume Capacity and ASU Mapping	20
SPC-1 Benchmark Execution Results	21
SPC-1 Tests, Test Phases, and Test Runs	21
Primary Metrics Test - Sustainability Test Phase	22
SPC-1 Workload Generator Input Parameters	22
Sustainability Test Results File	22
Sustainability - Data Rate Distribution Data (MB/second).....	23

Sustainability – Data Rate Distribution Graph	24
Sustainability – I/O Request Throughput Distribution Data	25
Sustainability – I/O Request Throughput Distribution Graph	26
Sustainability – Average Response Time (ms) Distribution Data	27
Sustainability – Average Response Time (ms) Distribution Graph	28
Sustainability – Response Time Frequency Distribution Data	29
Sustainability – Response Time Frequency Distribution Graph	29
Sustainability – Measured Intensity Multiplier and Coefficient of Variation.....	30
Primary Metrics Test – IOPS Test Phase	31
SPC-1 Workload Generator Input Parameters	31
IOPS Test Results File.....	31
IOPS Test Run – I/O Request Throughput Distribution Data	32
IOPS Test Run – I/O Request Throughput Distribution Graph.....	32
IOPS Test Run – Average Response Time (ms) Distribution Data.....	33
IOPS Test Run – Average Response Time (ms) Distribution Graph	33
IOPS Test Run – Response Time Frequency Distribution Data	34
IOPS Test Run –Response Time Frequency Distribution Graph.....	34
IOPS Test Run – I/O Request Information.....	35
IOPS Test Run – Measured Intensity Multiplier and Coefficient of Variation.....	35
Primary Metrics Test – Response Time Ramp Test Phase	36
SPC-1 Workload Generator Input Parameters	36
Response Time Ramp Test Results File.....	36
Response Time Ramp Distribution (IOPS) Data.....	37
Response Time Ramp Distribution (IOPS) Graph	38
SPC-1 LRT™ Average Response Time (ms) Distribution Data.....	39
SPC-1 LRT™ Average Response Time (ms) Distribution Graph	39
SPC-1 LRT™ (10%) – Measured Intensity Multiplier and Coefficient of Variation	40
Repeatability Test	41
SPC-1 Workload Generator Input Parameters	41
Repeatability Test Results File	42
Repeatability 1 LRT – I/O Request Throughput Distribution Data.....	43
Repeatability 1 LRT – I/O Request Throughput Distribution Graph	43
Repeatability 1 LRT –Average Response Time (ms) Distribution Data	44
Repeatability 1 LRT –Average Response Time (ms) Distribution Graph.....	44
Repeatability 1 IOPS – I/O Request Throughput Distribution Data	45
Repeatability 1 IOPS – I/O Request Throughput Distribution Graph.....	45
Repeatability 1 IOPS –Average Response Time (ms) Distribution Data.....	46
Repeatability 1 IOPS –Average Response Time (ms) Distribution Graph	46
Repeatability 2 LRT – I/O Request Throughput Distribution Data.....	47

Repeatability 2 LRT – I/O Request Throughput Distribution Graph	47
Repeatability 2 LRT –Average Response Time (ms) Distribution Data	48
Repeatability 2 LRT –Average Response Time (ms) Distribution Graph.....	48
Repeatability 2 IOPS – I/O Request Throughput Distribution Data	49
Repeatability 2 IOPS – I/O Request Throughput Distribution Graph.....	49
Repeatability 2 IOPS –Average Response Time (ms) Distribution Data.....	50
Repeatability 2 IOPS –Average Response Time (ms) Distribution Graph	50
Repeatability 1 (LRT) Measured Intensity Multiplier and Coefficient of Variation	51
Repeatability 1 (IOPS) Measured Intensity Multiplier and Coefficient of Variation	51
Repeatability 2 (LRT) Measured Intensity Multiplier and Coefficient of Variation	51
Repeatability 2 (IOPS) Measured Intensity Multiplier and Coefficient of Variation	52
Data Persistence Test.....	53
SPC-1 Workload Generator Input Parameters	53
Data Persistence Test Results File	53
Data Persistence Test Results.....	54
Priced Storage Configuration Availability Date.....	55
Pricing Information.....	55
Anomalies or Irregularities	55
Appendix A: SPC-1 Glossary	56
“Decimal” (<i>powers of ten</i>) Measurement Units.....	56
“Binary” (<i>powers of two</i>) Measurement Units.....	56
SPC-1 Data Repository Definitions.....	56
SPC-1 Data Protection Levels	57
SPC-1 Test Execution Definitions	57
I/O Completion Types	59
SPC-1 Test Run Components	59
Appendix B: Customer Tunable Parameters and Options.....	60
Windows Server 2003 Registry Changes.....	60
Storage Array Cache Block Size	60
Volume Segment Size	60
RDAC Failover Options.....	60
Host Bus Adapter Options.....	61
Appendix C: Tested Storage Configuration (TSC) Creation	62
Define Host Access and TSC Configuration.....	62
Define Windows Partitions, Volumes, and Stripe Sets.....	62
1932_8_2plus2.script.....	63
doSPC.bat.....	65

diskpart.txt	65
convertDynamic.script.....	65
createVolumes.script.....	66
Appendix D: SPC-1 Workload Generator Storage Commands and Parameters	67
Appendix E: SPC-1 Workload Generator Input Parameters	68
Primary Metrics Test, Repeatability Test, and Persistence Test Run 1	68
Persistence Test Run 2.....	68

AUDIT CERTIFICATION



Bruce McNutt
IBM Corporation
KBV/9042-2
9000 South Rita Road
Tucson, AZ 85744

February 26, 2008

The SPC Benchmark 1™ results listed below for the IBM Systems Storage DS3400 were produced in compliance with the SPC Benchmark 1™ V1.10.1 Remote Audit requirements.

SPC Benchmark 1™ V1.10.1 Results	
Tested Storage Configuration (TSC) Name:	
IBM Systems Storage DS3400	
Metric	Reported Result
SPC-1 IOPS™	9,000.88
SPC-1 Price-Performance	\$5.19/SPC-1 IOPS™
Total ASU Capacity	981.132 GB
Data Protection Level	Mirroring
Total TSC Price (including three-year maintenance)	\$46,695

The following SPC Benchmark 1™ Remote Audit requirements were reviewed and found compliant with V1.10.1 of the SPC Benchmark 1™ specification:

- A Letter of Good Faith, signed by a senior executive.
- The following Data Repository storage items were verified by information supplied by IBM Corporation:
 - ✓ Physical Storage Capacity and requirements.
 - ✓ Configured Storage Capacity and requirements.
 - ✓ Addressable Storage Capacity and requirements.
 - ✓ Capacity of each Logical Volume and requirements.
 - ✓ Capacity of each Application Storage Unit (ASU) and requirements.
- An appropriate diagram of the Benchmark Configuration (BC)/Tested Storage Configuration (TSC).

Storage Performance Council
643 Bair Island Road, Suite 103
Redwood City, CA 94062
AuditService@storageperformance.org
650.556.9384

AUDIT CERTIFICATION (CONT.)

IBM Systems Storage DS3400
SPC-1 Audit Certification

Page 2

- Listings and commands to configure the Benchmark Configuration/Tested Storage Configuration, including customer tunable parameters.
- Commands and parameters used to configure the SPC-1 Workload Generator.
- The following Host System requirements were verified by information supplied by IBM Corporation:
 - ✓ The type of Host System including the number of processors and main memory.
 - ✓ The presence and version number of the Workload Generator on the Host System.
 - ✓ The TSC boundary within the Host System.
- The Test Results Files and resultant Summary Results Files received from IBM Corporation for each of following were authentic, accurate, and compliant with all of the requirements and constraints of Clauses 4 and 5 of the SPC-1 Benchmark Specification:
 - ✓ Data Persistence Test
 - ✓ Sustainability Test Phase
 - ✓ IOPS Test Phase
 - ✓ Response Time Ramp Test Phase
 - ✓ Repeatability Test
- The differences between the Tested Storage Configuration (TSC) used for the benchmark and Priced Storage Configuration were documented and, if applied to the TSC, would not have a negative impact on the reported SPC-1 performance.
- The submitted pricing information met all of the requirements and constraints of Clause 8 of the SPC-1 Benchmark Specification.
- The Full Disclosure Report (FDR) met all of the requirements in Clause 9 of the SPC-1 Benchmark Specification.

Audit Notes:

There were no audit notes or exceptions.

Respectfully,

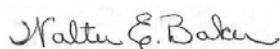

Walter E. Baker
SPC Auditor

Storage Performance Council
643 Bair Island Road, Suite 103
Redwood City, CA 94062
AuditService@storageperformance.org
650.556.9384

LETTER OF GOOD FAITH



Vice President, BLE, Disk Storage
IBM Technology & Systems Group
5600 Cottle Road, San Jose, California 95193

Phone: 408-256-7405
Fax: 408-256-7420

November 9, 2007

Mr. Walter E. Baker, SPC Auditor
Gradient Systems, Inc.
643 Bair Island Road, Suite 103
Redwood City, CA 94063

Subject: SPC-1 Letter of Good Faith for the IBM System Storage DS3400

IBM Corporation is the SPC-1 Test Sponsor for the above listed product. To the best of our knowledge and belief, the required SPC-1 benchmark results and materials we have submitted for that product are complete, accurate, and in full compliance with Version 1.10.1 of the SPC-1 benchmark specification.

Our disclosure of the Benchmark configuration and execution of the benchmark includes all items that, to the best of our knowledge and belief, materially affect the reported results, regardless of whether such items are explicitly required to be disclosed by the SPC-1 benchmark specification.

Sincerely,

A handwritten signature in black ink, appearing to read "Barry Rudolph", is located below the "Sincerely," text.

Barry Rudolph

EXECUTIVE SUMMARY**Test Sponsor and Contact Information**

Test Sponsor and Contact Information	
Test Sponsor Primary Contact	IBM Corporation – http://www.ibm.com Bruce McNutt – bmcnutt@us.ibm.com KBV/9042-2 9000 South Rita Road Tucson, AZ 85744 Phone: (520) 799-2460 FAX: (520) 799-5530
Test Sponsor Alternate Contact	IBM Corporation – http://www.ibm.com Vernon Miller – millerv@us.ibm.com YNOA/9042 9000 South Rita Road Tucson, AZ 85744 Phone: (520) 799-4849 FAX: (520) 799-5530
Auditor	Storage Performance Council – http://www.storageperformance.org Walter E. Baker – AuditService@StoragePerformance.org 643 Bair Island Road, Suite 103 Redwood City, CA 94063 Phone: (650) 556-9384 FAX: (650) 556-9385

Revision Information and Key Dates

Revision Information and Key Dates	
SPC-1 Specification revision number	V1.10.1
SPC-1 Workload Generator revision number	V2.00.04a
Date Results were first used publicly	February 27, 2008
Date the FDR was submitted to the SPC	February 27, 2008
Date the revised FDR was submitted to the SPC Revised SPC-1 Price-Performance (<i>page 12</i>) Revised pricing (<i>page 14</i>)	March 4, 2008
Date the TSC is available for shipment to customers	currently available
Date the TSC completed audit certification	February 26, 2008

Tested Storage Product (TSP) Description

The DS3400 is a 4 Gb external Fibre Channel storage solution that is easy to deploy and manage. Available in single and dual controller models, the DS3400 scales in capacity to support a total of 48 hard disk drives by using the EXP3000 expansion unit. The DS3400 is a direct-attach and SAN solution for System x, and BladeCenter servers, and enables small and medium businesses to manage their fast-growing data capacity requirements on an affordable budget. Features include:

- 2U rack mount enclosure with 12 easily accessible drive bays
- Support for dual-ported, and hot-swappable SAS disks at 10,000 and 15,000 rpm speeds
- Scalability of up to 3.6 TB of storage capacity with 300 GB hot-swappable SAS disks
- Expandable by attaching up to three EXP3000s, or a total of 48 hard disk drives
- Built-in reliability features with dual-redundant power-supplies standard
- Three-year limited warranty(1) on parts and labor

Summary of Results

SPC-1 Results	
Tested Storage Configuration (TSC) Name: IBM System Storage DS3400	
Metric	Reported Result
SPC-1 IOPS™	9,000.88
SPC-1 Price-Performance	\$3.79/SPC-1 IOPS™
Total ASU Capacity	981.132 GB
Data Protection Level	Mirroring
Total TSC Price (including three-year maintenance)	\$34,127

SPC-1 IOPS™ represents the maximum I/O Request Throughput at the 100% load point.

Total ASU (Application Storage Unit) Capacity represents the total storage capacity read and written in the course of executing the SPC-1 benchmark.

A **Data Protection Level of Mirroring** configures two or more identical copies of user data.

Storage Capacities and Relationships

The following diagram documents the various storage capacities, used in this benchmark, and their relationships.

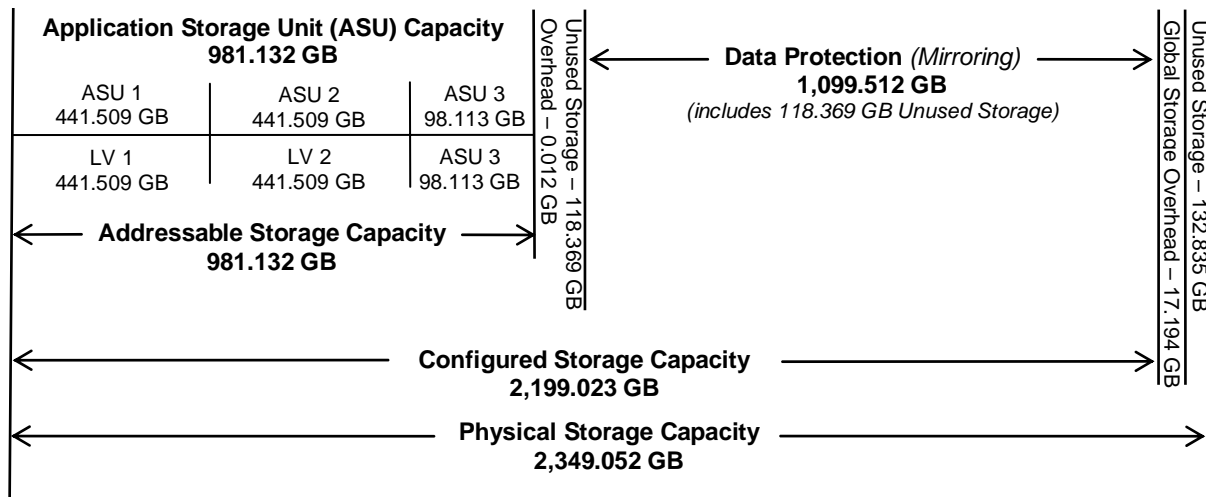

Response Time – Throughput Curve

The Response Time-Throughput Curve illustrates the Average Response Time (milliseconds) and I/O Request Throughput at 100%, 95%, 90%, 80%, 50%, and 10% of the workload level used to generate the SPC-1 IOPS™ metric.

The Average Response Time measured at any of the above load points cannot exceed 30 milliseconds or the benchmark measurement is invalid.

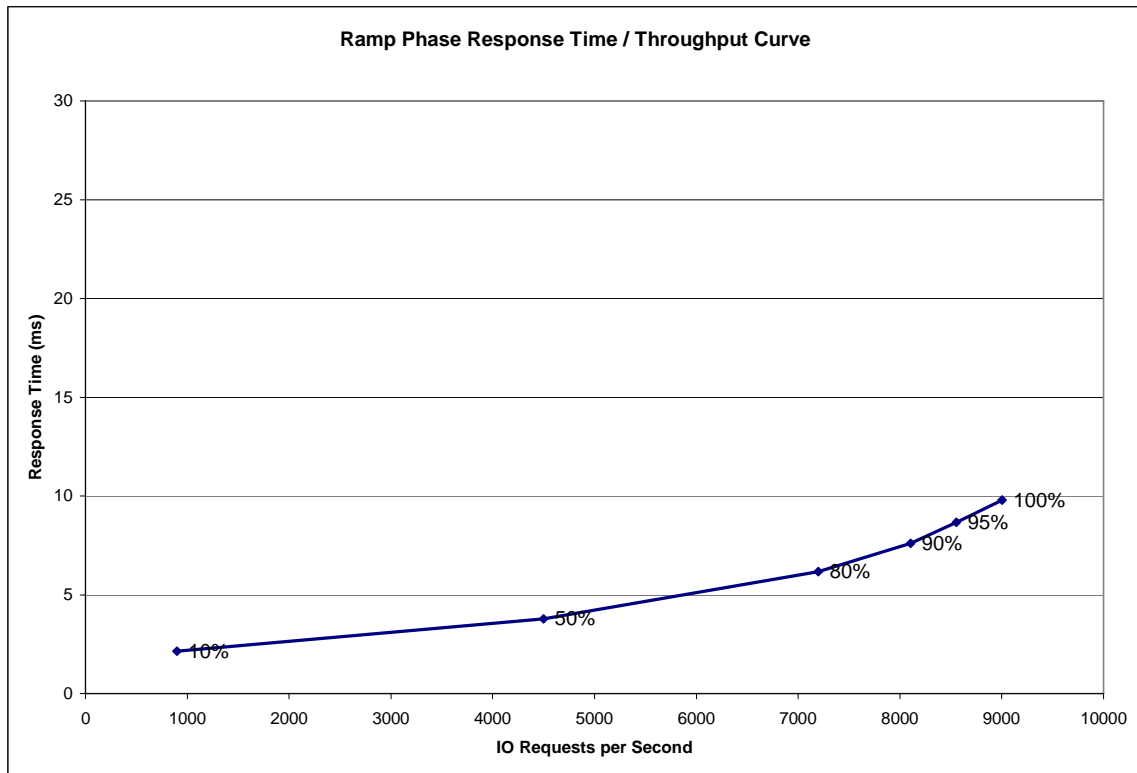

Response Time – Throughput Data

	10% Load	50% Load	80% Load	90% Load	95% Load	100% Load
I/O Request Throughput	899.38	4,498.43	7,199.33	8,105.39	8,553.28	9,000.88
Average Response Time (ms):						
All ASUs	2.15	3.79	6.18	7.61	8.66	9.81
ASU-1	2.73	4.78	7.27	8.67	9.66	10.73
ASU-2	2.60	4.91	9.96	13.78	16.47	19.57
ASU-3	0.72	1.20	2.22	2.65	3.13	3.55
Reads	4.43	7.89	12.47	15.54	17.60	19.95
Writes	0.67	1.12	2.08	2.44	2.83	3.20

Tested Storage Configuration Pricing (*Priced Storage Configuration*)

Description	Part Numbers	Qty	Price	Extended Price
DS3400 Dual Controller (incl 4 SFP's and 4 -5M Cables)	172642E	1	\$8,749	\$8,749
SAS Cables	39R6529	4	\$119	\$476
73 GB SAS 3.5" HDDs	40K1043	32	\$309	\$9,888
HBA's (QLA2462)	39R6527	2	\$1,899	\$3,798
EXP3000	172701X	2	\$3,199	\$6,398
ESM for EXP3000	39R6515	2	\$999	\$1,998
3yr. 24.7.4hr Upgrade				\$2,820
			Total	\$34,127

Differences between the Tested Storage Configuration (TSC) and Priced Storage Configuration

The difference between the Tested Storage Configuration and Priced Storage Configuration is that the priced disk drives are mounted in an IBM drive carrier and each disk drive is configured to self-identify as a DS3000 brand. That difference, if applied to the TSC, would not have a negative impact on the reported SPC-1 performance.

Benchmark Configuration/Tested Storage Configuration Diagram

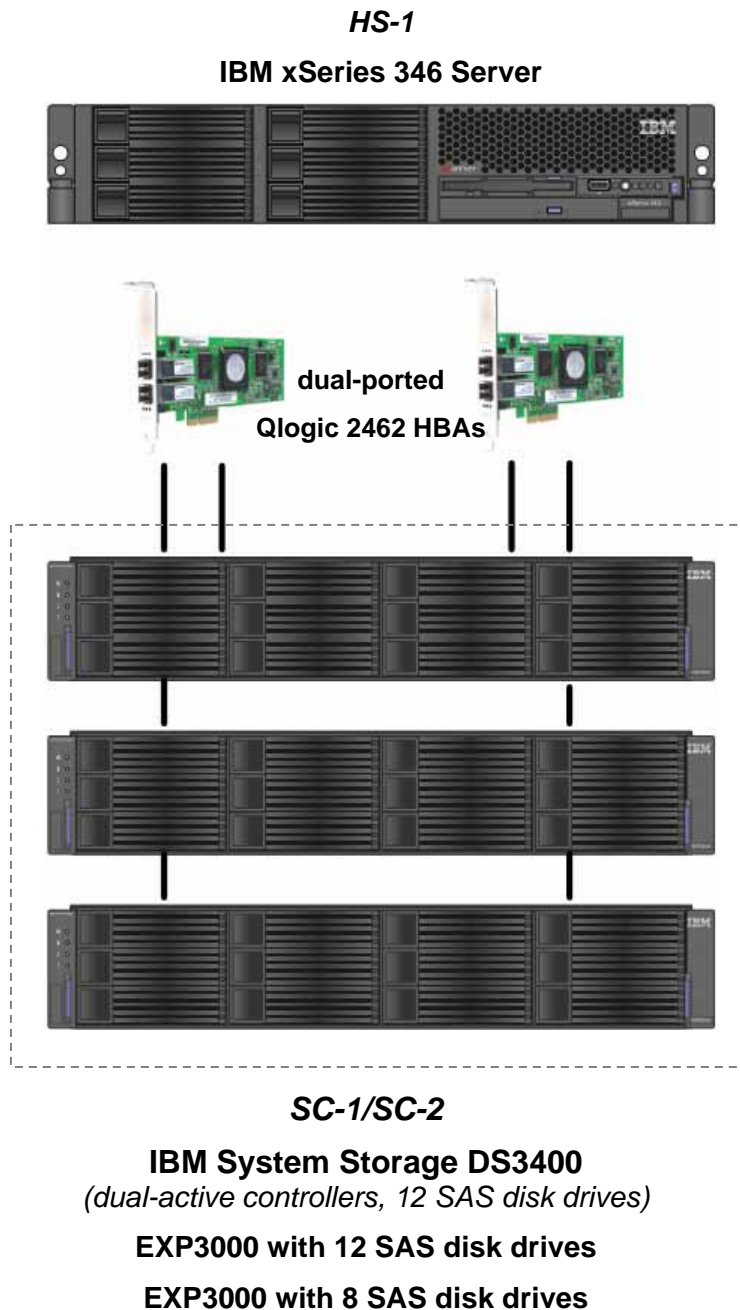

Benchmark Configuration/Tested Storage Configuration Components

Host System:	Tested Storage Configuration (TSC):
HS-1: IBM xSeries 346 Server	2 – dual-ported Qlogic 2462 HBAs
2 – 3.4 GHz Xeon CPUs with 1 MB L2 cache per CPU	SC-1/SC-2: IBM System Storage DS3400
4 GB main memory	2 – dual-active controllers each with:
Windows Server 2003 Enterprise Edition with SP1	512 MB cache
PCI-X	2 – 4 Gb Fibre Channel host connections <i>(4 total, 4 used)</i>
WG:	1 – 4x 3 Gb SAS drive connection <i>(2 total, 2 used)</i>
	2 – EXP3000 expansion units
	32 – 73 GB 15K RPM disk drives

In each of the following sections of this document, the appropriate Full Disclosure Report requirement, from the SPC-1 benchmark specification, is stated in italics followed by the information to fulfill the stated requirement.

CONFIGURATION INFORMATION

Benchmark Configuration (BC)/Tested Storage Configuration (TSC) Diagram

Clause 9.2.4.4.1

A one page Benchmark Configuration (BC)/Tested Storage Configuration (TSC) diagram shall be included in the Executive Summary...

The Benchmark Configuration (BC)/Tested Storage Configuration (TSC) is illustrated on page 15 (*Benchmark Configuration/Tested Storage Configuration Diagram*).

Storage Network Configuration

Clause 9.2.4.4.1

...

5. *If the TSC contains network storage, the diagram will include the network configuration. If a single diagram is not sufficient to illustrate both the Benchmark Configuration and network configuration in sufficient detail, the Benchmark Configuration diagram will include a high-level network illustration as shown in Figure 9-8. In that case, a separate, detailed network configuration diagram will also be included as described in Clause 9.2.4.4.2.*

Clause 9.2.4.4.2

If a storage network was configured as a part of the Tested Storage Configuration and the Benchmark Configuration diagram described in Clause 9.2.4.4.1 contains a high-level illustration of the network configuration, the Executive Summary will contain a one page topology diagram of the storage network as illustrated in Figure 9-9.

The Benchmark Configuration (BC)/Tested Storage Configuration (TSC), including the network configuration, is illustrated on page 15 (*Benchmark Configuration/Tested Storage Configuration Diagram*).

Host System Configuration

Clause 9.2.4.4.3

The FDR shall minimally contain, for each Host System running the Workload Generator, a listing of the following:

1. *Number and type of CPUs.*
2. *Main memory capacity.*
3. *Cache memory capacity.*
4. *Number and type of disk controllers or Host Bus Adapters.*

The details of the Host System configuration may be found on page 15 (*Benchmark Configuration/Tested Storage Configuration Diagram*).

Customer Tunable Parameters and Options

Clause 9.2.4.5.1

All Benchmark Configuration (BC) components with customer tunable parameter and options that have been altered from their default values must be listed in the FDR. The FDR entry for each of those components must include both the name of the component and the altered value of the parameter or option. If the parameter name is not self-explanatory to a knowledgeable practitioner, a brief description of the parameter's use must also be included in the FDR entry.

“Appendix B: Customer Tunable Parameters and Options” on page 60 contains the customer tunable parameters and options that have been altered from their default values for this benchmark.

Tested Storage Configuration (TSC) Description

Clause 9.2.4.5.2

The FDR must include sufficient information to recreate the logical representation of the TSC. In addition to customer tunable parameters and options (Clause 4.2.4.5.3), that information must include, at a minimum:

- A diagram and/or description of the following:
 - All physical components that comprise the TSC. Those components are also illustrated in the BC Configuration Diagram in Clause 9.2.4.4.1 and/or the Storage Network Configuration Diagram in Clause 9.2.4.4.2.
 - The logical representation of the TSC, configured from the above components that will be presented to the Workload Generator.
- Listings of scripts used to create the logical representation of the TSC.
- If scripts were not used, a description of the process used with sufficient detail to recreate the logical representation of the TSC.

“Appendix C: Tested Storage Configuration (TSC) Creation” on page 62 contains the detailed information that describes how to create and configure the logical TSC.

SPC-1 Workload Generator Storage Configuration

Clause 9.2.4.5.3

The FDR must include all SPC-1 Workload Generator storage configuration commands and parameters.

The SPC-1 Workload Generator storage configuration commands and parameters for this measurement appear in “Appendix D: SPC-1 Workload Generator Storage Commands and Parameters” on page 67.

SPC-1 DATA REPOSITORY

This portion of the Full Disclosure Report presents the detailed information that fully documents the various SPC-1 storage capacities and mappings used in the Tested Storage Configuration. “SPC-1 Data Repository Definitions” on page 56 contains definitions of terms specific to the SPC-1 Data Repository.

Storage Capacities and Relationships

Clause 9.2.4.6.1

Two tables and an illustration documenting the storage capacities and relationships of the SPC-1 Storage Hierarchy (Clause 2.1) shall be included in the FDR.

SPC-1 Storage Capacities

SPC-1 Storage Capacities		
Storage Hierarchy Component	Units	Capacity
Total ASU Capacity	Gigabytes (GB)	981.132
Addressable Storage Capacity	Gigabytes (GB)	981.132
Configured Storage Capacity	Gigabytes (GB)	2,199.023
Physical Storage Capacity	Gigabytes (GB)	2,349.052
Data Protection (<i>Mirroring</i>)	Gigabytes (GB)	1,099.512
Required Storage (<i>spares/metadata</i>)	Gigabytes (GB)	0.000
Global Storage Overhead	Gigabytes (GB)	17.194
Total Unused Storage	Gigabytes (GB)	369.573

SPC-1 Storage Hierarchy Ratios

	Addressable Storage Capacity	Configured Storage Capacity	Physical Storage Capacity
Total ASU Capacity	100.00%	44.62%	41.77%
Required for Data Protection (<i>Mirroring</i>)		50.00%	46.81%
Addressable Storage Capacity		44.62%	41.77%
Required Storage		0.00%	0.00%
Configured Storage Capacity			93.61%
Global Storage Overhead			0.73%
Unused Storage:			
Addressable	0.00%		
Configured		10.77%	
Physical			5.65%

The Physical Storage Capacity consisted of 2,349.052 GB distributed over 32 disk drives each with a formatted capacity of 73.408 GB. There was 132.835 GB (5.65%) of Unused Storage within the Physical Storage Capacity. Global Storage Overhead consisted of 17.194 GB (0.73%) of Physical Storage Capacity. There was 236.739 GB (10.77%) of Unused Storage within the Configured Storage Capacity. The Total ASU Capacity utilized 100% of the Addressable Storage Capacity resulting in 0.00 GB (0.00%) of Unused Storage within the Addressable Storage Capacity.

SPC-1 Storage Capacities and Relationships Illustration

The various storage capacities configured in the benchmark result are illustrated below (not to scale).

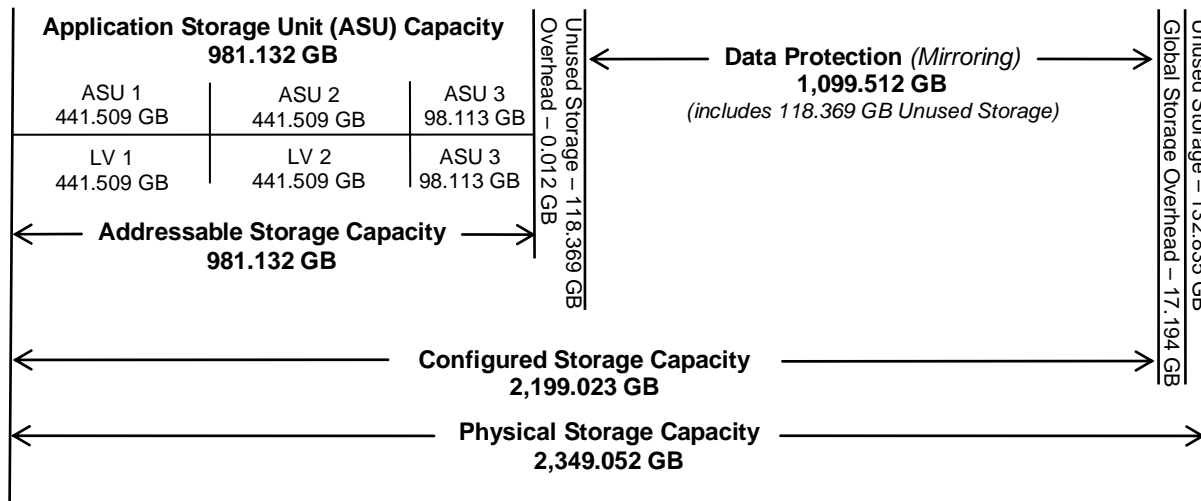

Logical Volume Capacity and ASU Mapping

Clause 9.2.4.6.2

A table illustrating the capacity of each ASU and the mapping of Logical Volumes to ASUs shall be provided in the FDR. ... Logical Volumes shall be sequenced in the table from top to bottom per its position in the contiguous address space of each ASU. The capacity of each Logical Volume shall be stated. ... In conjunction with this table, the Test Sponsor shall provide a complete description of the type of data protection (see Clause 2.4.5) used on each Logical Volume.

Logical Volume Capacity and Mapping		
ASU-1 (441.509 GB)	ASU-2 (441.509 GB)	ASU-3 (98.113 GB)
1 Logical Volume 441.509 GB per Logical Volume (441.509 GB used per Logical Volume)	1 Logical Volume 441.509 GB per Logical Volume (441.509 GB used per Logical Volume)	1 Logical Volume 98.113 GB per Logical Volume (98.113 GB used per Logical Volume)

The Data Protection Level used for all Logical Volumes was Mirroring as described on page 12. See “ASU Configuration” in the [IOPS Test Results File](#) for more detailed configuration information.

SPC-1 BENCHMARK EXECUTION RESULTS

This portion of the Full Disclosure Report documents the results of the various SPC-1 Tests, Test Phases, and Test Runs. “SPC-1 Test Execution Definitions” on page 57 contains definitions of terms specific to the SPC-1 Tests, Test Phases, and Test Runs.

Clause 5.4.3

The Tests must be executed in the following sequence: Primary Metrics, Repeatability, and Data Persistence. That required sequence must be uninterrupted from the start of Primary Metrics to the completion of Persistence Test Run 1. Uninterrupted means the Benchmark Configuration shall not be power cycled, restarted, disturbed, altered, or adjusted during the above measurement sequence. If the required sequence is interrupted other than for the Host System/TSC power cycle between the two Persistence Test Runs, the measurement is invalid.

SPC-1 Tests, Test Phases, and Test Runs

The SPC-1 benchmark consists of the following Tests, Test Phases, and Test Runs:

- **Primary Metrics Test**
 - Sustainability Test Phase and Test Run
 - IOPS Test Phase and Test Run
 - Response Time Ramp Test Phase
 - 95% of IOPS Test Run
 - 90% of IOPS Test Run
 - 80% of IOPS Test Run
 - 50% of IOPS Test Run
 - 10% of IOPS Test Run (LRT)
- **Repeatability Test**
 - Repeatability Test Phase 1
 - 10% of IOPS Test Run (LRT)
 - IOPS Test Run
 - Repeatability Test Phase 2
 - 10% of IOPS Test Run (LRT)
 - IOPS Test Run
- **Data Persistence Test**
 - Data Persistence Test Run 1
 - Data Persistence Test Run 2

Each Test is an atomic unit that must be executed from start to finish before any other Test, Test Phase, or Test Run may be executed.

The results from each Test, Test Phase, and Test Run are listed below along with a more detailed explanation of each component.

Primary Metrics Test – Sustainability Test Phase

Clause 5.4.4.1.1

The Sustainability Test Phase has exactly one Test Run and shall demonstrate the maximum sustainable I/O Request Throughput within at least a continuous three (3) hour Measurement Interval. This Test Phase also serves to insure that the TSC has reached Steady State prior to reporting the final maximum I/O Request Throughput result (SPC-1 IOPS™).

Clause 5.4.4.1.2

The computed I/O Request Throughput of the Sustainability Test must be within 5% of the reported SPC-1 IOPS™ result.

Clause 5.4.4.1.4

The Average Response Time, as defined in Clause 5.1.1, will be computed and reported for the Sustainability Test Run and cannot exceed 30 milliseconds. If the Average Response time exceeds that 30-milliseconds constraint, the measurement is invalid.

Clause 9.2.4.7.1

For the Sustainability Test Phase the FDR shall contain:

- 1. A Data Rate Distribution graph and data table.*
- 2. I/O Request Throughput Distribution graph and data table.*
- 3. A Response Time Frequency Distribution graph and table.*
- 4. An Average Response Time Distribution graph and table.*
- 5. The human readable Test Run Results File produced by the Workload Generator (may be included in an appendix).*
- 6. A listing or screen image of all input parameters supplied to the Workload Generator (may be included in an appendix).*
- 7. The Measured Intensity Multiplier for each I/O stream.*
- 8. The variability of the Measured Intensity Multiplier, as defined in Clause 5.3.13.3.*

SPC-1 Workload Generator Input Parameters

The SPC-1 Workload Generator input parameters for the Sustainability, IOPS, Response Time Ramp, Repeatability, and Persistence Test Runs are documented in “Appendix E: SPC-1 Workload Generator Input Parameters” on Page 68.

Sustainability Test Results File

A link to the test results file generated from the Sustainability Test Run is listed below.

[Sustainability Test Results File](#)

Sustainability – Data Rate Distribution Data (MB/second)

	Start	Stop	Interval	Duration										
Ramp-Up/Start-Up	9:15:37	9:20:37	0-4	0:05:00										
Measurement Interval	9:20:37	12:20:37	4-184	3:00:00										
Interval	All ASUs	ASU1	ASU2	ASU3	Interval	All ASUs	ASU1	ASU2	ASU3	Interval	All ASUs	ASU1	ASU2	ASU3
0	73.76	28.63	7.89	37.24	63	73.74	28.71	7.89	37.14	126	73.68	28.63	7.85	37.21
1	73.78	28.66	7.89	37.23	64	73.98	28.71	7.94	37.34	127	73.51	28.69	7.83	36.99
2	74.03	28.74	7.94	37.35	65	73.88	28.69	7.87	37.31	128	73.87	28.75	7.87	37.25
3	73.96	28.76	7.84	37.35	66	73.74	28.70	7.91	37.13	129	74.09	28.86	7.85	37.37
4	74.21	28.70	7.90	37.61	67	73.74	28.85	7.89	36.99	130	74.20	28.75	7.88	37.56
5	74.10	28.76	7.90	37.44	68	73.92	28.83	7.90	37.20	131	73.97	28.67	7.88	37.42
6	73.83	28.65	7.95	37.24	69	73.65	28.68	7.82	37.15	132	73.83	28.73	7.85	37.25
7	73.76	28.85	7.84	37.07	70	73.93	28.73	8.04	37.16	133	73.76	28.56	7.92	37.27
8	73.96	28.69	7.84	37.44	71	73.90	28.70	7.92	37.28	134	73.96	28.85	7.85	37.26
9	73.89	28.78	7.96	37.15	72	73.68	28.62	7.96	37.10	135	74.08	28.74	7.93	37.40
10	73.80	28.74	7.90	37.16	73	73.82	28.72	7.86	37.25	136	74.08	28.72	7.93	37.44
11	73.65	28.67	7.83	37.15	74	73.80	28.67	7.91	37.22	137	73.97	28.69	7.86	37.42
12	73.87	28.75	7.86	37.25	75	74.01	28.69	7.90	37.42	138	73.84	28.71	7.89	37.23
13	73.66	28.69	7.90	37.06	76	74.11	28.76	7.89	37.45	139	73.74	28.65	8.01	37.08
14	73.88	28.64	7.81	37.44	77	73.85	28.62	7.92	37.32	140	73.83	28.68	7.96	37.19
15	73.87	28.66	7.98	37.23	78	74.00	28.69	7.88	37.44	141	73.60	28.69	7.83	37.08
16	73.69	28.74	7.88	37.06	79	73.80	28.67	7.88	37.25	142	74.02	28.74	7.83	37.46
17	73.91	28.71	7.94	37.26	80	73.79	28.54	7.84	37.41	143	73.80	28.74	7.85	37.22
18	74.30	28.76	7.96	37.58	81	73.62	28.62	7.94	37.05	144	73.76	28.60	7.84	37.31
19	73.97	28.82	7.83	37.32	82	73.75	28.71	7.81	37.23	145	73.72	28.67	7.90	37.16
20	74.25	28.67	7.94	37.64	83	74.00	28.64	7.94	37.42	146	73.72	28.66	7.93	37.14
21	74.17	28.84	7.96	37.37	84	74.07	28.77	7.87	37.43	147	74.00	28.69	7.91	37.39
22	74.08	28.79	7.91	37.38	85	74.21	28.80	7.96	37.46	148	73.75	28.62	7.90	37.23
23	73.87	28.64	8.05	37.19	86	74.01	28.80	7.95	37.26	149	73.65	28.61	7.87	37.17
24	73.38	28.68	7.93	36.77	87	73.80	28.73	7.91	37.16	150	73.85	28.65	7.88	37.31
25	73.53	28.60	7.85	37.08	88	73.64	28.57	7.90	37.17	151	73.91	28.72	7.93	37.26
26	74.27	28.72	7.92	37.63	89	73.92	28.72	7.84	37.36	152	73.63	28.68	7.84	37.10
27	74.00	28.68	7.81	37.51	90	73.88	28.70	8.00	37.18	153	73.82	28.69	7.86	37.27
28	73.78	28.68	7.82	37.28	91	74.01	28.59	7.90	37.53	154	74.00	28.59	7.92	37.49
29	74.00	28.81	7.91	37.28	92	73.68	28.56	7.85	37.28	155	73.82	28.74	7.85	37.23
30	73.63	28.58	7.92	37.14	93	73.87	28.63	7.96	37.29	156	73.97	28.90	7.84	37.23
31	73.97	28.92	7.81	37.24	94	73.91	28.69	7.90	37.32	157	73.88	28.74	7.78	37.36
32	73.96	28.75	7.89	37.31	95	73.60	28.53	7.88	37.19	158	74.04	28.81	7.85	37.39
33	73.86	28.77	7.88	37.21	96	73.90	28.67	7.92	37.31	159	73.71	28.45	7.84	37.41
34	74.17	28.66	7.88	37.63	97	74.03	28.72	7.85	37.46	160	73.62	28.57	7.89	37.16
35	73.90	28.64	8.01	37.25	98	73.88	28.75	7.85	37.28	161	73.64	28.55	7.84	37.26
36	73.91	28.68	7.83	37.39	99	73.63	28.63	7.87	37.12	162	73.50	28.61	7.81	37.08
37	73.66	28.64	7.78	37.23	100	74.00	28.79	7.89	37.32	163	73.61	28.63	7.77	37.21
38	73.88	28.69	7.85	37.34	101	73.84	28.58	7.89	37.37	164	73.87	28.66	7.95	37.26
39	73.73	28.80	7.88	37.04	102	73.88	28.76	7.92	37.20	165	73.89	28.59	7.94	37.36
40	73.53	28.55	7.86	37.11	103	73.78	28.58	8.00	37.19	166	73.77	28.78	7.73	37.26
41	73.84	28.54	8.04	37.26	104	74.25	28.71	7.99	37.55	167	73.68	28.72	7.89	37.07
42	73.86	28.58	7.86	37.41	105	73.85	28.62	7.90	37.33	168	73.67	28.72	7.82	37.14
43	73.68	28.77	7.85	37.05	106	74.19	28.79	7.92	37.47	169	73.64	28.72	7.83	37.10
44	73.58	28.62	7.83	37.13	107	73.48	28.66	7.78	37.03	170	73.57	28.65	7.90	37.02
45	73.60	28.62	7.83	37.16	108	73.95	28.66	7.94	37.35	171	74.09	28.67	7.96	37.46
46	73.93	28.73	7.89	37.30	109	73.92	28.67	7.90	37.36	172	73.75	28.64	7.79	37.32
47	73.64	28.59	7.87	37.18	110	73.82	28.66	7.88	37.28	173	73.53	28.62	7.84	37.07
48	73.65	28.56	7.92	37.18	111	73.84	28.75	7.88	37.20	174	73.99	28.76	7.94	37.29
49	73.95	28.77	7.94	37.24	112	73.90	28.59	7.96	37.34	175	73.89	28.73	7.83	37.33
50	74.03	28.77	7.81	37.45	113	73.84	28.59	7.95	37.29	176	73.94	28.79	7.96	37.19
51	74.15	28.75	7.93	37.47	114	73.68	28.56	7.88	37.25	177	73.96	28.65	7.91	37.41
52	73.80	28.61	7.87	37.32	115	73.43	28.55	7.75	37.13	178	73.98	28.75	7.89	37.34
53	73.59	28.58	7.84	37.16	116	73.73	28.59	7.92	37.22	179	74.07	28.72	7.98	37.37
54	73.76	28.58	7.76	37.42	117	73.94	28.78	7.88	37.28	180	73.83	28.62	7.88	37.33
55	73.58	28.66	7.87	37.05	118	73.72	28.55	7.92	37.25	181	74.07	28.82	7.86	37.39
56	73.72	28.60	7.87	37.25	119	73.41	28.63	7.86	36.92	182	74.06	28.72	7.88	37.46
57	73.55	28.58	7.92	37.05	120	74.01	28.64	7.93	37.44	183	73.95	28.74	7.88	37.33
58	73.88	28.60	7.87	37.40	121	73.90	28.64	7.85	37.41	184	74.05	28.66	7.85	37.53
59	74.28	28.62	7.95	37.70	122	73.63	28.55	7.93	37.14					
60	73.90	28.70	7.97	37.24	123	73.71	28.69	7.91	37.11					
61	73.56	28.70	7.89	36.96	124	73.94	28.77	7.91	37.25					
62	74.27	28.79	7.91	37.58	125	73.65	28.60	7.90	37.14					

Sustainability – Data Rate Distribution Graph

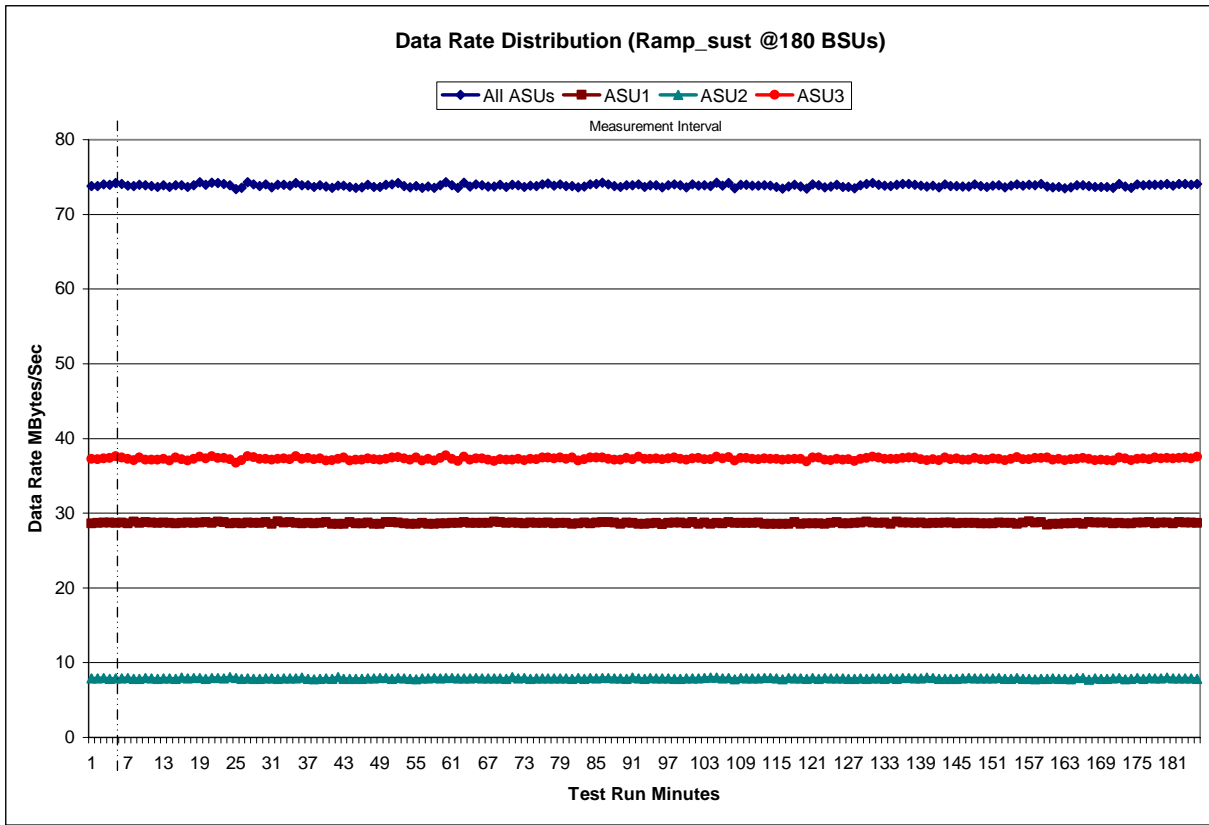

Sustainability – I/O Request Throughput Distribution Data

Ramp-Up/Start-Up Measurement Interval		Start	Stop	Interval	Duration															
		9:15:37	9:20:37	0-4	0:05:00															
		9:20:37	12:20:37	5-184	3:00:00															
Interval	All ASUs	ASU1	ASU2	ASU3	Interval	All ASUs	ASU1	ASU2	ASU3	Interval	All ASUs	ASU1	ASU2	ASU3						
0	9,013.50	5,370.58	1,113.77	2,529.15	63	8,968.72	5,341.45	1,107.90	2,519.37	126	9,003.58	5,367.50	1,103.68	2,532.40						
1	9,005.50	5,365.22	1,110.27	2,530.02	64	9,009.43	5,364.27	1,109.15	2,536.02	127	8,992.83	5,371.05	1,102.13	2,519.65						
2	9,011.05	5,368.07	1,111.62	2,531.37	65	9,000.63	5,364.72	1,099.73	2,536.18	128	8,996.90	5,365.10	1,103.22	2,528.58						
3	8,995.48	5,364.70	1,104.02	2,526.77	66	9,006.13	5,362.13	1,115.92	2,528.08	129	9,016.65	5,380.37	1,107.12	2,529.17						
4	9,006.95	5,365.82	1,104.70	2,536.43	67	9,003.87	5,378.38	1,105.42	2,520.07	130	9,019.17	5,377.15	1,105.32	2,536.70						
5	9,003.35	5,356.83	1,108.85	2,537.67	68	9,024.65	5,391.60	1,105.72	2,527.33	131	9,005.20	5,365.18	1,104.98	2,535.03						
6	8,999.38	5,367.73	1,107.02	2,524.63	69	9,000.98	5,367.15	1,107.10	2,526.73	132	9,003.32	5,373.85	1,104.95	2,524.52						
7	9,005.25	5,377.68	1,102.33	2,525.23	70	9,030.78	5,385.42	1,114.62	2,530.75	133	8,995.27	5,360.47	1,109.58	2,525.22						
8	9,020.58	5,377.07	1,108.52	2,535.00	71	8,999.78	5,367.55	1,109.50	2,522.73	134	9,010.53	5,377.53	1,106.65	2,526.35						
9	9,001.27	5,368.52	1,109.37	2,523.38	72	9,006.42	5,361.70	1,110.80	2,533.92	135	9,004.80	5,374.83	1,101.88	2,528.08						
10	8,987.23	5,360.97	1,098.82	2,527.45	73	8,996.22	5,356.63	1,112.28	2,527.30	136	9,006.37	5,365.38	1,108.60	2,532.38						
11	8,969.85	5,342.48	1,106.10	2,521.27	74	8,992.18	5,362.13	1,103.65	2,526.40	137	9,022.23	5,370.15	1,108.25	2,543.83						
12	9,016.45	5,375.45	1,109.25	2,531.75	75	9,018.78	5,376.37	1,108.90	2,533.52	138	9,012.28	5,369.18	1,109.85	2,533.25						
13	8,994.35	5,365.75	1,109.05	2,519.55	76	9,020.65	5,375.10	1,115.15	2,530.40	139	9,006.67	5,360.00	1,118.95	2,527.72						
14	9,002.98	5,355.08	1,113.25	2,534.65	77	8,998.90	5,357.38	1,111.37	2,530.15	140	9,001.17	5,368.58	1,107.93	2,524.65						
15	8,991.27	5,355.65	1,110.53	2,525.08	78	9,014.10	5,369.55	1,110.97	2,533.58	141	8,979.50	5,357.38	1,105.22	2,516.90						
16	9,008.50	5,373.12	1,109.90	2,525.48	79	8,995.70	5,363.38	1,105.17	2,527.15	142	9,000.08	5,369.55	1,105.58	2,524.95						
17	9,000.47	5,364.97	1,108.68	2,526.82	80	8,991.32	5,355.15	1,103.97	2,532.20	143	8,999.07	5,361.58	1,108.35	2,529.13						
18	9,004.08	5,361.88	1,110.73	2,531.47	81	8,988.18	5,356.23	1,109.37	2,522.58	144	8,990.53	5,357.62	1,108.63	2,524.28						
19	9,015.62	5,382.35	1,100.12	2,533.15	82	9,005.12	5,361.45	1,109.88	2,533.78	145	8,992.40	5,360.55	1,110.15	2,521.70						
20	9,019.50	5,361.25	1,113.87	2,544.38	83	9,011.65	5,375.20	1,105.17	2,531.28	146	8,974.32	5,342.78	1,106.72	2,524.82						
21	9,028.85	5,383.00	1,111.02	2,534.83	84	8,998.98	5,369.73	1,098.70	2,530.55	147	9,007.83	5,367.87	1,103.63	2,536.33						
22	9,024.20	5,382.73	1,105.98	2,535.48	85	8,995.85	5,366.55	1,101.43	2,527.87	148	8,987.78	5,361.68	1,105.05	2,521.05						
23	8,989.98	5,352.95	1,114.77	2,522.27	86	9,008.13	5,378.38	1,110.20	2,519.55	149	8,999.98	5,352.80	1,109.30	2,537.88						
24	8,983.25	5,363.22	1,108.33	2,511.70	87	9,013.62	5,369.62	1,114.55	2,529.45	150	9,019.92	5,374.07	1,109.32	2,536.53						
25	8,981.83	5,352.65	1,105.25	2,523.93	88	8,994.00	5,364.80	1,108.18	2,521.02	151	9,018.63	5,366.28	1,113.88	2,538.47						
26	9,021.13	5,364.15	1,111.87	2,545.12	89	9,012.52	5,370.62	1,106.63	2,535.27	152	8,961.97	5,347.00	1,097.60	2,517.37						
27	9,001.98	5,361.53	1,108.15	2,532.30	90	9,018.48	5,377.85	1,112.15	2,528.48	153	9,008.83	5,373.55	1,103.57	2,531.72						
28	8,992.12	5,362.00	1,101.32	2,528.80	91	8,999.55	5,358.20	1,102.35	2,539.00	154	9,001.42	5,366.43	1,107.15	2,527.83						
29	9,016.27	5,370.22	1,109.28	2,536.77	92	8,992.68	5,347.15	1,114.38	2,531.15	155	8,998.63	5,361.83	1,110.43	2,526.37						
30	8,987.00	5,348.52	1,105.53	2,532.95	93	9,008.73	5,359.00	1,116.75	2,532.98	156	9,004.65	5,375.25	1,104.52	2,524.88						
31	9,007.92	5,378.72	1,107.27	2,521.93	94	8,997.57	5,356.60	1,109.88	2,531.08	157	9,003.05	5,357.83	1,095.52	2,549.70						
32	9,011.82	5,371.57	1,108.15	2,532.10	95	8,979.42	5,350.87	1,102.88	2,525.67	158	9,026.12	5,384.70	1,106.40	2,535.02						
33	8,996.67	5,368.08	1,110.38	2,518.20	96	8,997.25	5,360.55	1,101.02	2,535.68	159	9,008.18	5,357.23	1,111.50	2,539.45						
34	9,011.57	5,373.77	1,100.23	2,537.57	97	8,998.75	5,373.55	1,095.78	2,529.42	160	8,983.70	5,355.72	1,108.07	2,519.92						
35	9,001.05	5,356.93	1,108.63	2,535.48	98	9,017.87	5,374.57	1,110.52	2,532.78	161	8,975.98	5,344.60	1,103.97	2,527.42						
36	9,005.38	5,371.52	1,101.55	2,532.32	99	8,995.92	5,365.58	1,105.43	2,524.90	162	8,982.58	5,353.87	1,101.08	2,527.63						
37	8,988.87	5,362.75	1,095.60	2,530.52	100	8,992.10	5,356.60	1,110.35	2,525.15	163	8,987.63	5,355.85	1,100.35	2,531.43						
38	9,006.95	5,366.27	1,104.30	2,536.38	101	9,011.45	5,366.35	1,113.33	2,531.77	164	9,005.90	5,364.03	1,108.82	2,533.05						
39	9,001.93	5,360.13	1,115.77	2,526.03	102	9,022.48	5,382.62	1,107.93	2,531.93	165	9,005.30	5,366.77	1,107.48	2,531.05						
40	8,971.68	5,350.12	1,106.12	2,515.45	103	8,991.40	5,354.90	1,111.62	2,524.88	166	8,998.07	5,372.22	1,098.78	2,527.07						
41	9,012.60	5,365.13	1,119.67	2,527.80	104	9,010.72	5,365.23	1,112.12	2,533.37	167	8,977.33	5,348.52	1,110.53	2,518.28						
42	8,988.85	5,356.12	1,102.07	2,530.67	105	8,998.37	5,358.72	1,108.17	2,531.48	168	8,980.72	5,361.72	1,097.00	2,522.00						
43	8,991.02	5,364.67	1,104.87	2,521.48	106	9,014.90	5,372.40	1,112.07	2,530.43	169	8,988.87	5,358.58	1,100.48	2,529.80						
44	8,982.53	5,354.13	1,099.52	2,528.88	107	9,005.17	5,371.32	1,108.80	2,525.05	170	8,982.47	5,351.87	1,108.42	2,522.18						
45	8,987.50	5,360.32	1,105.98	2,521.20	108	8,992.52	5,357.32	1,106.12	2,529.08	171	9,016.68	5,367.08	1,111.22	2,538.38						
46	8,995.25	5,358.23	1,107.40	2,529.62	109	8,994.45	5,358.55	1,109.17	2,526.73	172	8,978.97	5,353.63	1,098.10	2,527.23						
47	8,976.72	5,354.25	1,102.52	2,519.95	110	8,991.62	5,359.62	1,103.28	2,528.72	173	8,985.02	5,355.12	1,102.00	2,527.90						
48	8,991.02	5,364.30	1,102.47	2,524.25	111	8,994.62	5,373.28	1,098.23	2,523.10	174	9,021.48	5,382.53	1,110.92	2,528.03						
49	9,010.42	5,372.80	1,104.88	2,532.73	112	9,008.50	5,357.22	1,116.03	2,535.25	175	9,009.33	5,371.23	1,107.53	2,530.57						
50	9,001.48	5,371.82	1,102.78	2,526.88	113	8,994.55	5,348.97	1,110.60	2,534.98	176	8,996.35	5,363.13	1,108.77	2,524.45						
51	9,025.85	5,378.30	1,106.98	2,540.57	114	8,989.15	5,358.72	1,109.80	2,520.63	177	8,993.63	5,353.65	1,109.87	2,530.12						
52	9,002.83	5,364.97	1,110.10	2,527.77	115	8,984.83	5,357.28	1,103.12	2,524.43	178	9,021.98	5,379.05	1,113.72	2,529.22						
53	8,987.23	5,350.03	1,105.60	2,531.60	116	8,992.92	5,359.52	1,105.23	2,528.17	179	9,013.63	5,365.67	1,110.50	2,537.47						
54	9,006.93	5,368.63	1,104.88	2,533.42	117	9,010.75	5,373.98	1,105.60	2,531.17	180	8,995.18	5,354.52	1,109.48	2,531.18						
55	8,987.95	5,359.87	1,106.20	2,521.88	118	8,972.70	5,342.67	1,109.33	2,520.70	181	9,021.87	5,377.85	1,106.92	2,537.10						
56	8,976.17	5,353.78	1,105.93	2,516.45	119	8,990.43	5,361.42	1,106.75	2,522.27	182	9,012.63	5,368.08	1,110.48	2,534.07						
57	8,999.20	5,362.22	1,110.03	2,526.95	120	9,010.47	5,375.63	1,107.30	2,527.53	183	8,999.42	5,371.83	1,102.67	2,524.92						
58	8,989.92	5,360.63	1,102.38	2,526.90	121	9,000.53	5,367.20	1,105.50	2,527.83	184	9,014.93	5,365.07	1,111.17	2,538.70						
59	9,017.77	5,362.15	1,112.77	2,542.85	122	8,989.28	5,350.67	1,109.72	2,528.90	Average	9,000.83	5,364.53	1,107.26	2,529.03						
60	9,000.77	5,360.63	1,111.57	2,528.57	123	9,008.15	5,375.12	1,107.15	2,525.88											
61	8,985.45	5,366.55	1,103.43	2,515.47	124	9,029.87	5,385.15	1,114.70	2,530.02											
62	9,021.83	5,373.00	1,111.83	2,537.00	125	8,993.85	5,353.93	1,108.73	2,531.18											

Sustainability – I/O Request Throughput Distribution Graph

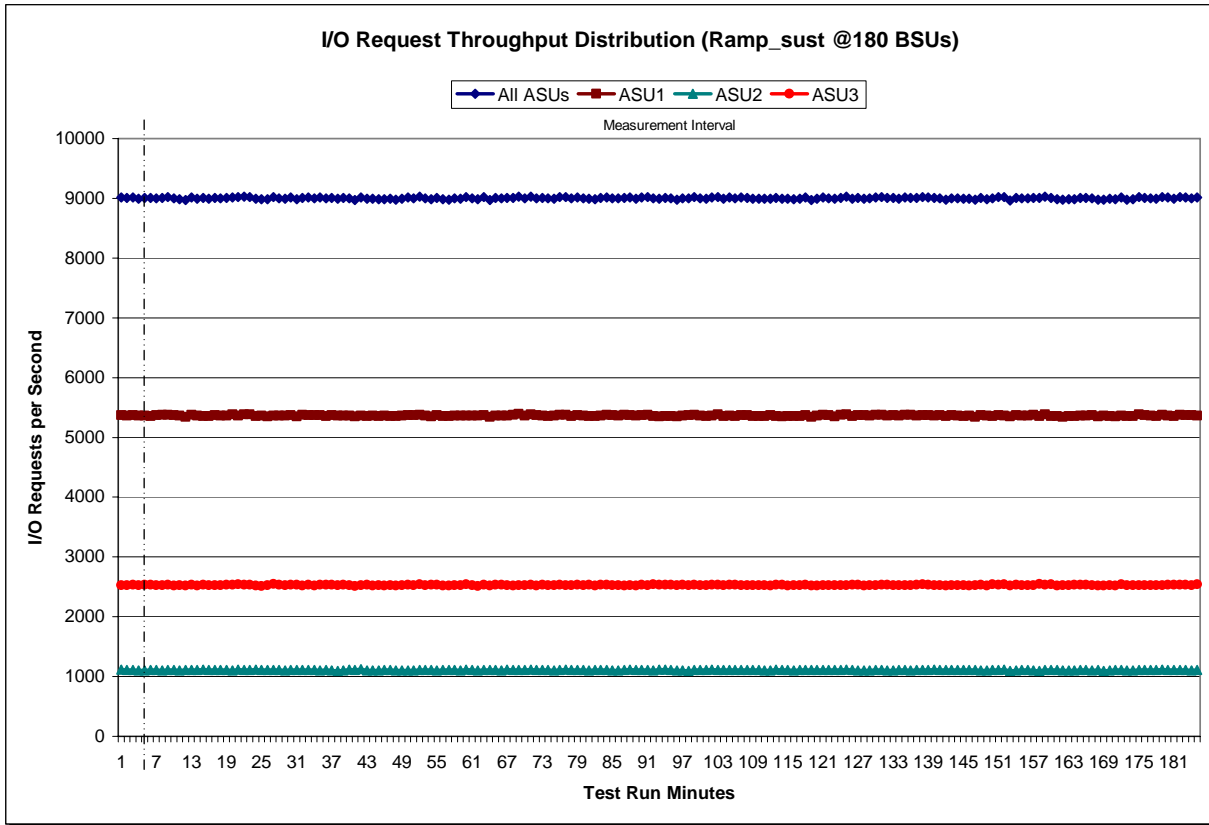

Sustainability – Average Response Time (ms) Distribution Data

	Start	Stop	Interval	Duration										
Ramp-Up/Start-Up	9:15:37	9:20:37	0-4	0:05:00										
Measurement Interval	9:20:37	12:20:37	4-184	3:00:00										
Interval	All ASUs	ASU1	ASU2	ASU3	Interval	All ASUs	ASU1	ASU2	ASU3	Interval	All ASUs	ASU1	ASU2	ASU3
0	9.67	10.55	18.63	3.86	63	9.71	10.63	19.16	3.58	126	9.71	10.71	19.34	3.40
1	9.56	10.56	19.13	3.26	64	9.76	10.69	19.40	3.57	127	9.80	10.74	19.55	3.53
2	9.70	10.59	19.41	3.56	65	9.85	10.78	19.77	3.59	128	9.66	10.68	19.25	3.30
3	9.59	10.52	19.03	3.50	66	9.97	10.89	19.55	3.78	129	9.70	10.65	19.52	3.38
4	9.63	10.61	19.03	3.46	67	9.74	10.71	19.55	3.38	130	9.71	10.66	19.56	3.39
5	9.52	10.54	18.90	3.28	68	9.69	10.69	19.28	3.36	131	10.43	11.17	20.29	4.56
6	9.69	10.60	19.60	3.43	69	9.66	10.62	19.47	3.32	132	9.71	10.67	19.20	3.49
7	9.70	10.64	19.40	3.48	70	10.06	10.99	19.52	3.93	133	9.71	10.68	19.56	3.32
8	9.69	10.68	19.16	3.43	71	9.94	10.85	19.91	3.62	134	9.66	10.62	19.35	3.37
9	9.74	10.62	19.66	3.52	72	9.67	10.60	19.48	3.38	135	9.60	10.61	19.21	3.28
10	9.51	10.49	19.10	3.28	73	9.67	10.70	19.12	3.33	136	9.57	10.50	19.40	3.30
11	9.60	10.58	19.24	3.30	74	9.54	10.54	18.99	3.27	137	10.00	10.95	19.60	3.81
12	9.67	10.63	19.35	3.39	75	9.73	10.66	19.59	3.42	138	9.66	10.67	19.27	3.30
13	9.51	10.53	18.83	3.23	76	9.68	10.65	19.26	3.38	139	9.85	10.85	19.58	3.42
14	9.98	10.86	19.59	3.88	77	9.64	10.55	19.36	3.45	140	9.84	10.74	19.92	3.50
15	9.74	10.64	19.66	3.46	78	9.88	10.84	19.32	3.69	141	9.48	10.46	19.00	3.21
16	9.70	10.63	19.66	3.35	79	9.55	10.49	19.19	3.33	142	9.74	10.73	19.32	3.46
17	9.86	10.79	19.20	3.79	80	9.83	10.74	19.45	3.70	143	9.64	10.63	19.04	3.42
18	9.69	10.67	19.46	3.33	81	9.54	10.52	19.08	3.26	144	9.73	10.67	19.68	3.35
19	9.78	10.71	19.69	3.48	82	9.99	10.89	19.63	3.85	145	9.68	10.62	19.36	3.42
20	9.92	10.84	19.70	3.72	83	9.54	10.48	19.31	3.29	146	9.66	10.60	19.09	3.52
21	10.21	11.12	19.81	4.08	84	10.24	11.04	20.10	4.29	147	9.64	10.62	19.21	3.42
22	9.77	10.72	19.63	3.45	85	10.69	11.40	20.35	4.98	148	9.73	10.65	19.41	3.53
23	9.73	10.67	19.46	3.45	86	9.79	10.69	19.72	3.48	149	9.64	10.59	19.36	3.37
24	9.57	10.56	19.01	3.27	87	9.69	10.64	19.30	3.42	150	9.70	10.61	19.89	3.31
25	9.56	10.51	19.26	3.30	88	9.68	10.64	19.32	3.40	151	9.60	10.60	19.30	3.23
26	9.70	10.67	19.28	3.46	89	9.74	10.68	19.58	3.45	152	9.88	10.76	19.63	3.74
27	9.62	10.63	19.10	3.31	90	9.59	10.51	19.25	3.39	153	9.90	10.81	19.56	3.74
28	9.60	10.62	19.30	3.21	91	9.58	10.56	19.27	3.31	154	9.68	10.67	19.28	3.37
29	9.72	10.69	19.30	3.47	92	9.95	10.81	19.56	3.90	155	9.58	10.55	19.25	3.27
30	9.56	10.55	18.96	3.35	93	9.61	10.59	18.94	3.44	156	9.71	10.67	19.48	3.39
31	9.72	10.70	19.41	3.40	94	9.58	10.51	19.23	3.40	157	10.24	11.09	20.23	4.18
32	9.71	10.69	19.12	3.51	95	9.60	10.58	19.24	3.32	158	9.94	10.86	19.61	3.77
33	9.72	10.71	19.47	3.31	96	9.63	10.65	19.12	3.37	159	9.70	10.64	19.28	3.52
34	9.67	10.61	19.43	3.46	97	9.61	10.62	19.26	3.29	160	9.72	10.68	19.20	3.50
35	9.54	10.52	19.01	3.33	98	9.66	10.67	19.31	3.30	161	9.73	10.67	19.37	3.53
36	9.70	10.68	19.31	3.46	99	9.71	10.62	19.61	3.42	162	9.64	10.59	19.33	3.41
37	9.90	10.81	19.57	3.77	100	9.75	10.64	19.58	3.52	163	9.55	10.58	18.87	3.33
38	9.62	10.56	19.47	3.34	101	9.88	10.84	19.43	3.66	164	9.66	10.65	19.26	3.36
39	9.73	10.71	19.14	3.47	102	9.70	10.64	19.52	3.40	165	9.87	10.77	19.60	3.72
40	9.54	10.52	19.11	3.24	103	9.67	10.62	19.45	3.36	166	9.77	10.71	19.54	3.51
41	9.83	10.76	19.44	3.58	104	9.72	10.69	19.37	3.44	167	9.63	10.59	19.35	3.33
42	9.61	10.58	19.23	3.37	105	10.15	10.98	19.68	4.21	168	9.96	10.91	19.26	3.90
43	9.44	10.43	18.98	3.16	106	10.03	10.92	20.06	3.72	169	9.61	10.57	19.55	3.24
44	9.63	10.59	19.25	3.43	107	9.58	10.55	19.08	3.33	170	9.76	10.69	19.39	3.56
45	9.65	10.60	19.12	3.47	108	9.60	10.61	19.22	3.26	171	9.71	10.67	19.35	3.47
46	9.65	10.62	19.25	3.40	109	9.66	10.65	19.06	3.44	172	9.55	10.52	19.14	3.33
47	9.71	10.61	19.62	3.46	110	9.61	10.61	19.37	3.25	173	9.69	10.59	19.45	3.51
48	9.61	10.58	19.26	3.32	111	9.75	10.66	19.56	3.53	174	9.71	10.69	19.38	3.39
49	9.76	10.67	19.71	3.48	112	9.81	10.74	19.46	3.59	175	9.87	10.80	19.43	3.72
50	10.01	10.85	19.73	3.96	113	9.96	10.94	19.38	3.77	176	9.64	10.55	19.47	3.40
51	9.70	10.68	19.29	3.46	114	9.74	10.66	19.48	3.51	177	9.68	10.62	19.48	3.38
52	9.68	10.65	19.39	3.35	115	9.46	10.43	19.05	3.21	178	9.68	10.63	19.37	3.38
53	9.63	10.63	19.13	3.37	116	9.69	10.65	19.38	3.44	179	9.64	10.57	19.46	3.37
54	9.72	10.66	19.33	3.54	117	9.70	10.67	19.39	3.42	180	9.66	10.59	19.34	3.45
55	9.57	10.60	18.77	3.34	118	9.56	10.52	19.02	3.36	181	9.71	10.68	19.53	3.38
56	10.04	10.86	19.49	4.16	119	10.35	11.13	19.93	4.48	182	9.70	10.68	19.27	3.44
57	9.66	10.59	19.44	3.40	120	9.91	10.84	19.55	3.69	183	9.70	10.65	19.52	3.37
58	9.70	10.61	19.54	3.49	121	9.62	10.63	19.10	3.33	184	9.63	10.62	19.20	3.34
59	9.61	10.60	19.28	3.29	122	9.87	10.76	19.62	3.71	Average	9.73	10.68	19.40	3.49
60	9.88	10.75	19.47	3.82	123	9.85	10.82	19.45	3.57					
61	9.56	10.51	19.22	3.28	124	9.87	10.83	19.73	3.48					
62	9.71	10.65	19.45	3.44	125	9.72	10.71	19.34	3.41					

Sustainability – Average Response Time (ms) Distribution Graph

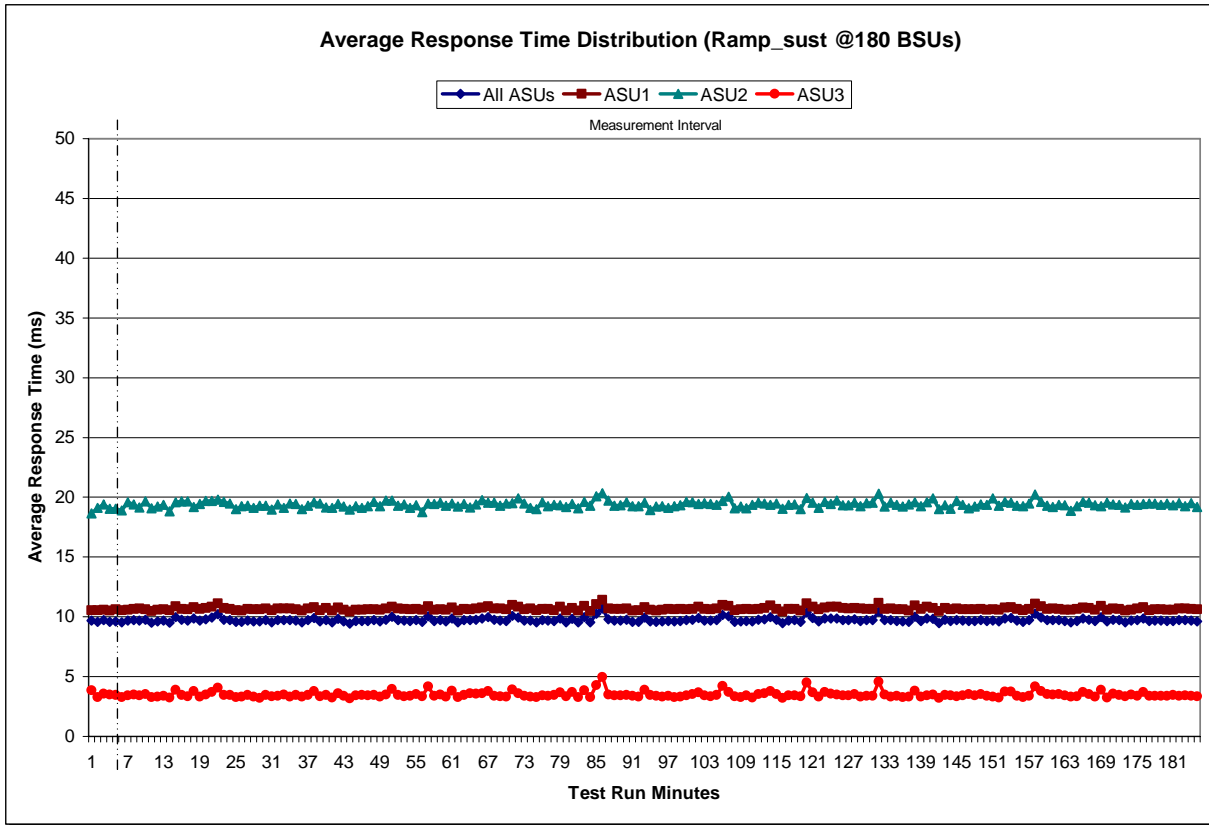

Sustainability – Response Time Frequency Distribution Data

Response Time (ms)	0-0.25	>0.25-0.5	>0.5-0.75	>0.75-1.0	>1.0-1.25	>1.25-1.5	>1.5-1.75	>1.75-2.0
Read	38,415	189,149	223,960	426,973	709,651	785,578	662,813	441,639
Write	-	6	62,410	1,190,978	5,527,388	8,732,651	9,349,544	6,972,906
All ASUs	38,415	189,155	286,370	1,617,951	6,237,039	9,518,229	10,012,357	7,414,545
ASU1	35,672	173,598	218,303	991,707	3,386,463	4,757,942	4,671,644	3,352,905
ASU2	2,743	15,557	54,582	263,656	851,282	1,174,342	1,142,509	810,623
ASU3	-	-	13,485	362,588	1,999,294	3,585,945	4,198,204	3,251,017
Response Time (ms)	>2.0-2.5	>2.5-3.0	>3.0-3.5	>3.5-4.0	>4.0-4.5	>4.5-5.0	>5.0-6.0	>6.0-7.0
Read	843,966	432,890	545,899	644,064	636,439	638,345	2,310,185	1,763,200
Write	8,585,471	5,937,695	4,485,839	2,696,784	1,251,060	886,126	1,031,665	451,077
All ASUs	9,429,437	6,370,585	5,031,738	3,340,848	1,887,499	1,524,471	3,341,850	2,214,277
ASU1	4,249,821	2,811,566	2,189,320	1,582,960	1,048,580	918,974	2,531,183	1,802,259
ASU2	1,033,975	645,522	438,985	276,330	147,574	115,832	241,981	172,033
ASU3	4,145,641	2,913,497	2,403,433	1,481,558	691,345	489,665	568,686	239,985
Response Time (ms)	>7.0-8.0	>8.0-9.0	>9.0-10.0	>10.0-15.0	>15.0-20.0	>20.0-25.0	>25.0-30.0	>30.0
Read	2,236,300	1,452,135	1,752,273	5,574,213	3,896,455	2,654,715	2,004,598	7,476,888
Write	309,883	170,979	147,296	315,302	119,066	67,110	52,729	524,116
All ASUs	2,546,183	1,623,114	1,899,569	5,889,515	4,015,521	2,721,825	2,057,327	8,001,004
ASU1	2,170,860	1,392,899	1,651,845	5,166,946	3,522,037	2,345,233	1,730,666	5,233,489
ASU2	213,503	142,843	171,825	556,724	424,403	334,107	292,319	2,435,146
ASU3	161,820	87,372	75,899	165,845	69,081	42,485	34,342	332,369

Sustainability – Response Time Frequency Distribution Graph

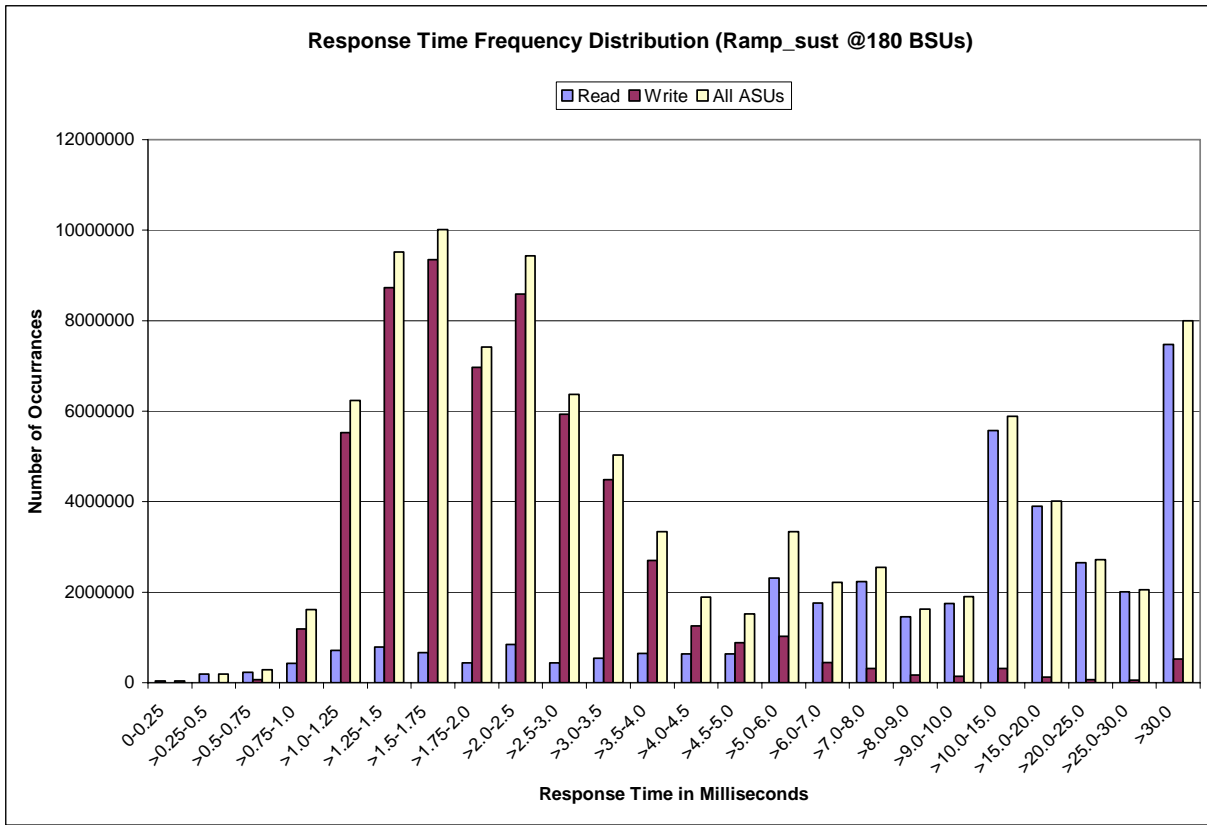

Sustainability – Measured Intensity Multiplier and Coefficient of Variation

Clause 3.4.3

IM – Intensity Multiplier: The ratio of I/Os for each I/O stream relative to the total I/Os for all I/O streams (ASU1-1 – ASU3-1) as required by the benchmark specification.

Clauses 5.1.0 and 5.3.13.2

MIM – Measured Intensity Multiplier: The Measured Intensity Multiplier represents the ratio of measured I/Os for each I/O stream relative to the total I/Os measured for all I/O streams (ASU1-1 – ASU3-1). This value may differ from the corresponding Expected Intensity Multiplier by no more than 5%.

Clause 5.3.13.3

COV – Coefficient of Variation: This measure of variation for the Measured Intensity Multiplier cannot exceed 0.2.

	ASU1-1	ASU1-2	ASU1-3	ASU1-4	ASU2-1	ASU2-2	ASU2-3	ASU3-1
IM	0.0350	0.2810	0.0700	0.2100	0.0180	0.0700	0.0350	0.2810
MIM	0.0350	0.2810	0.0700	0.2100	0.0180	0.0700	0.0350	0.2810
COV	0.007	0.002	0.004	0.003	0.011	0.005	0.007	0.002

Primary Metrics Test – IOPS Test Phase

Clause 5.4.2.2

The IOPS Test Phase consists of one Test Run at the 100% load point with a Measurement Interval of ten (10) minutes. The IOPS Test Phase immediately follows the Sustainability Test Phase without any interruption or manual intervention.

The IOPS Test Run generates the SPC-1 IOPS™ primary metric, which is computed as the I/O Request Throughput for the Measurement Interval of the IOPS Test Run.

The Average Response Time is computed for the IOPS Test Run and cannot exceed 30 milliseconds. If the Average Response Time exceeds the 30 millisecond constraint, the measurement is invalid.

Clause 9.2.4.7.2

For the IOPS Test Phase the FDR shall contain:

- 1. I/O Request Throughput Distribution (data and graph).*
- 2. A Response Time Frequency Distribution.*
- 3. An Average Response Time Distribution.*
- 4. The human readable Test Run Results File produced by the Workload Generator.*
- 5. A listing or screen image of all input parameters supplied to the Workload Generator.*
- 6. The total number of I/O Requests completed in the Measurement Interval as well as the number of I/O Requests with a Response Time less than or equal to 30 milliseconds and the number of I/O Requests with a Response Time greater than 30 milliseconds.*

SPC-1 Workload Generator Input Parameters

The SPC-1 Workload Generator input parameters for the Sustainability, IOPS, Response Time Ramp, Repeatability, and Persistence Test Runs are documented in “Appendix E: SPC-1 Workload Generator Input Parameters” on Page 68.

IOPS Test Results File

A link to the test results file generated from the IOPS Test Run is listed below.

[IOPS Test Results File](#)

IOPS Test Run – I/O Request Throughput Distribution Data

180 BSUs	Start	Stop	Interval	Duration
<i>Start-Up/Ramp-Up</i>	12:20:39	12:25:40	0-4	0:05:01
<i>Measurement Interval</i>	12:25:40	12:35:40	3-14	0:10:00
60 second intervals	All ASUs	ASU1	ASU2	ASU3
0	9,005.18	5,370.52	1,110.77	2,523.90
1	9,004.15	5,370.68	1,116.73	2,516.73
2	9,008.07	5,374.82	1,105.15	2,528.10
3	8,983.60	5,366.65	1,103.12	2,513.83
4	9,023.33	5,381.27	1,106.30	2,535.77
5	9,031.90	5,389.73	1,105.32	2,536.85
6	9,015.00	5,381.58	1,107.68	2,525.73
7	9,011.25	5,363.97	1,110.25	2,537.03
8	8,998.18	5,352.87	1,117.08	2,528.23
9	8,988.97	5,363.27	1,103.37	2,522.33
10	9,006.88	5,371.10	1,106.50	2,529.28
11	8,989.07	5,358.80	1,104.68	2,525.58
12	8,995.75	5,367.07	1,108.88	2,519.80
13	8,998.25	5,365.43	1,109.40	2,523.42
14	8,973.55	5,345.52	1,105.47	2,522.57
Average	9,000.88	5,365.93	1,107.86	2,527.08

IOPS Test Run – I/O Request Throughput Distribution Graph

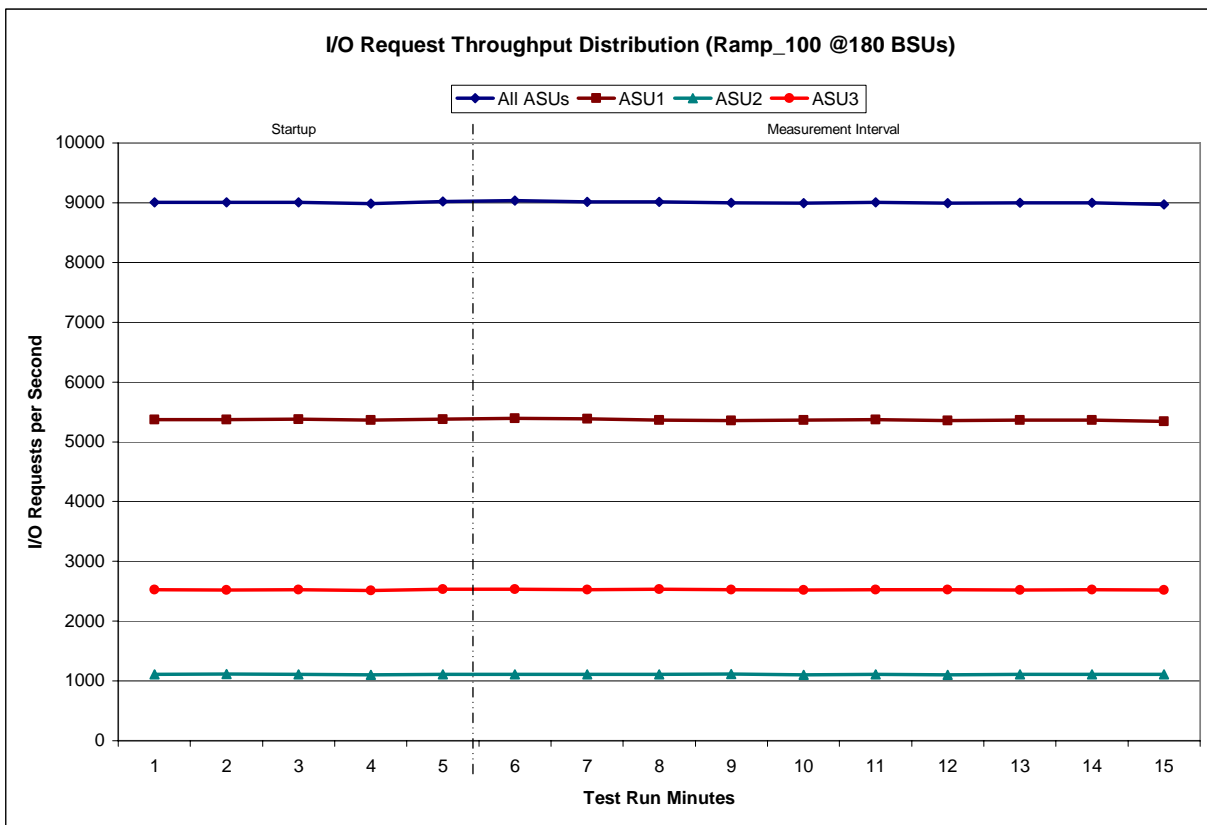

IOPS Test Run – Average Response Time (ms) Distribution Data

180 BSUs	Start	Stop	Interval	Duration
<i>Start-Up/Ramp-Up</i>	12:20:39	12:25:40	0-4	0:05:01
<i>Measurement Interval</i>	12:25:40	12:35:40	3-14	0:10:00
60 second intervals	All ASUs	ASU1	ASU2	ASU3
0	9.71	10.61	19.50	3.50
1	9.73	10.69	19.39	3.38
2	9.70	10.64	19.33	3.48
3	9.74	10.72	19.40	3.42
4	9.80	10.76	19.52	3.55
5	9.93	10.88	19.72	3.63
6	9.70	10.66	19.55	3.35
7	9.89	10.86	19.40	3.69
8	9.65	10.58	19.53	3.32
9	9.73	10.63	19.64	3.46
10	9.74	10.66	19.57	3.50
11	9.79	10.69	19.76	3.53
12	9.77	10.69	19.54	3.51
13	10.15	11.00	19.99	3.99
14	9.71	10.70	19.02	3.54
Average	9.81	10.73	19.57	3.55

IOPS Test Run – Average Response Time (ms) Distribution Graph

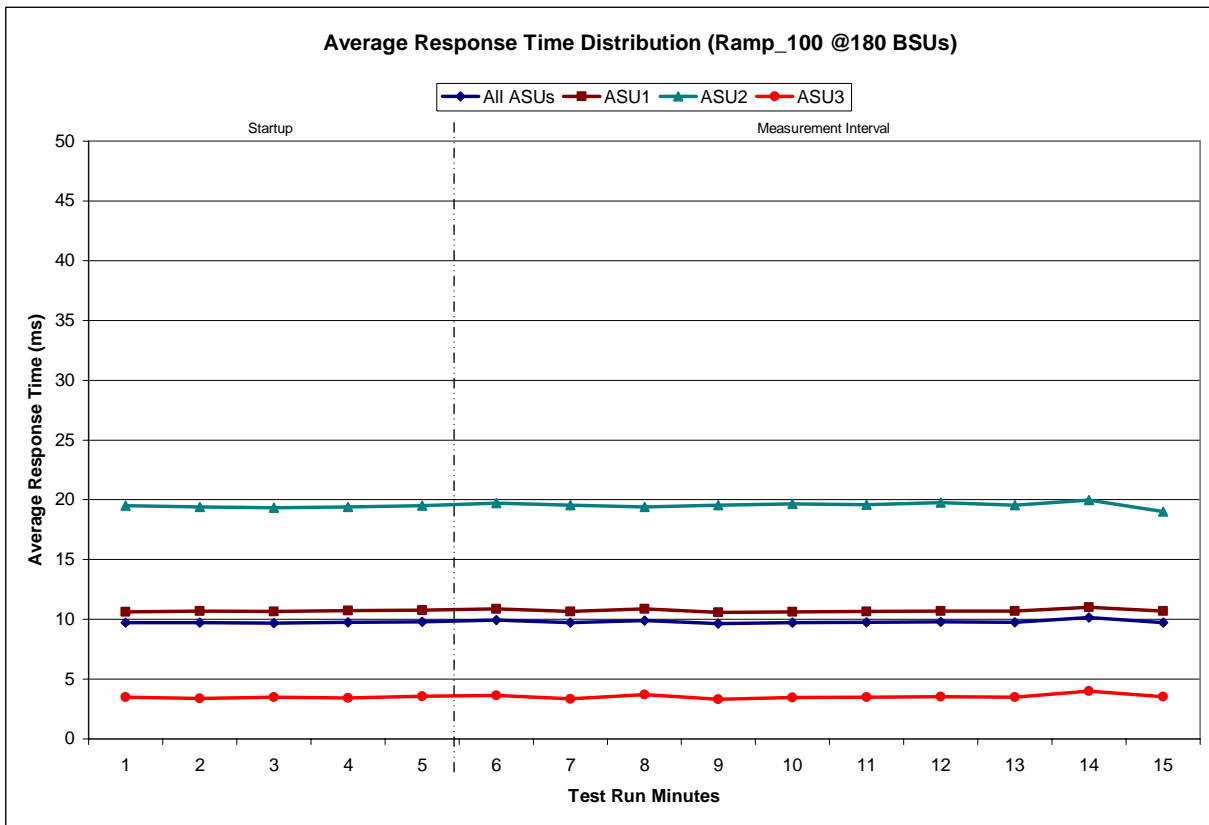

IOPS Test Run – Response Time Frequency Distribution Data

Response Time (ms)	0-0.25	>0.25-0.5	>0.5-0.75	>0.75-1.0	>1.0-1.25	>1.25-1.5	>1.5-1.75	>1.75-2.0
Read	2271	11,166	12,701	23,729	39,638	43,296	36,529	24,026
Write	0	1	3,440	66,357	305,497	479,198	514,656	384,566
All ASUs	2271	11,167	16,141	90,086	345,135	522,494	551,185	408,592
ASU1	2092	10,301	12,384	55,309	187,904	261,342	258,065	184,769
ASU2	179	866	3,014	14,517	47,313	64,097	62,806	44,930
ASU3	0	-	743	20,260	109,918	197,055	230,314	178,893

Response Time (ms)	>2.0-2.5	>2.5-3.0	>3.0-3.5	>3.5-4.0	>4.0-4.5	>4.5-5.0	>5.0-6.0	>6.0-7.0
Read	47,170	24,261	30,488	35,538	35,301	35,617	127,625	98,713
Write	480,961	333,811	250,833	150,987	70,686	49,519	58,462	25,688
All ASUs	528,131	358,072	281,321	186,525	105,987	85,136	186,087	124,401
ASU1	237,626	158,189	122,517	88,521	58,740	51,327	140,330	100,943
ASU2	58,399	36,259	24,605	15,327	8,240	6,505	13,579	9,752
ASU3	232,106	163,624	134,199	82,677	39,007	27,304	32,178	13,706

Response Time (ms)	>7.0-8.0	>8.0-9.0	>9.0-10.0	>10.0-15.0	>15.0-20.0	>20.0-25.0	>25.0-30.0	>30.0
Read	123,582	80,795	97,013	309,214	215,544	146,855	110,690	418,308
Write	17,204	9,376	7,799	17,009	6,899	4,099	3,043	30,244
All ASUs	140,786	90,171	104,812	326,223	222,443	150,954	113,733	448,552
ASU1	119,941	77,303	91,288	286,659	194,878	129,750	95,369	293,930
ASU2	11,918	7,977	9,503	30,632	23,627	18,653	16,348	135,656
ASU3	8,927	4,891	4,021	8,932	3,938	2,551	2,016	18,966

IOPS Test Run –Response Time Frequency Distribution Graph

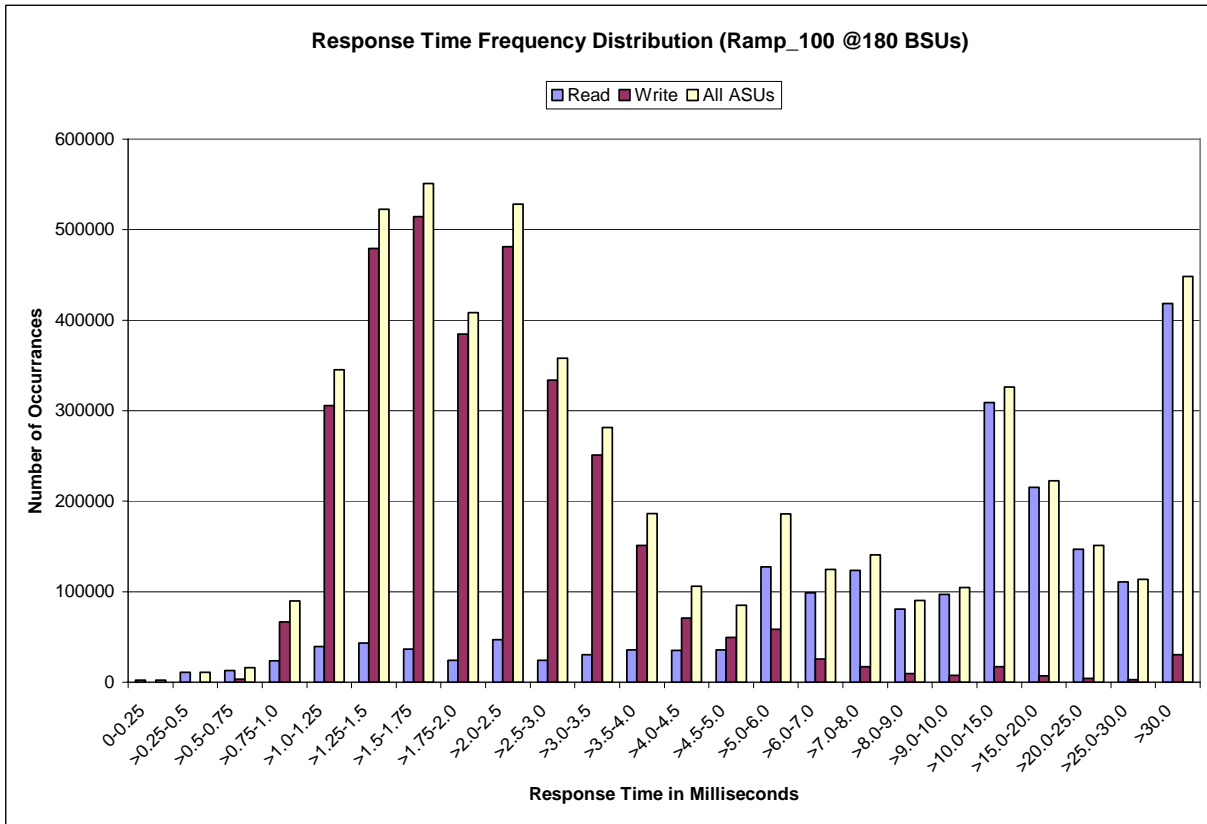

IOPS Test Run – I/O Request Information

I/O Requests Completed in the Measurement Interval	I/O Requests Completed with Response Time = or < 30 ms	I/O Requests Completed with Response Time > 30 ms
5,400,405	4,951,853	448,552

IOPS Test Run – Measured Intensity Multiplier and Coefficient of Variation

Clause 3.4.3

IM – Intensity Multiplier: The ratio of I/Os for each I/O stream relative to the total I/Os for all I/O streams (ASU1-1 – ASU3-1) as required by the benchmark specification.

Clauses 5.1.0 and 5.3.13.2

MIM – Measured Intensity Multiplier: The Measured Intensity Multiplier represents the ratio of measured I/Os for each I/O stream relative to the total I/Os measured for all I/O streams (ASU1-1 – ASU3-1). This value may differ from the corresponding Expected Intensity Multiplier by no more than 5%.

Clause 5.3.13.3

COV – Coefficient of Variation: This measure of variation for the Measured Intensity Multiplier cannot exceed 0.2.

	ASU1-1	ASU1-2	ASU1-3	ASU1-4	ASU2-1	ASU2-2	ASU2-3	ASU3-1
IM	0.0350	0.2810	0.0700	0.2100	0.0180	0.0700	0.0350	0.2810
MIM	0.0351	0.2810	0.0701	0.2100	0.0181	0.0701	0.0349	0.2808
COV	0.007	0.001	0.006	0.002	0.012	0.006	0.007	0.002

Primary Metrics Test – Response Time Ramp Test Phase

Clause 5.4.2.3

The Response Time Ramp Test Phase consists of five Test Runs, one each at 95%, 90%, 80%, 50%, and 10% of the load point (100%) used to generate the SPC-1 IOPS™ primary metric. Each of the five Test Runs has a Measurement Interval of ten (10) minutes. The Response Time Ramp Test Phase immediately follows the IOPS Test Phase without any interruption or manual intervention.

The five Response Time Ramp Test Runs, in conjunction with the IOPS Test Run (100%), demonstrate the relationship between Average Response Time and I/O Request Throughput for the Tested Storage Configuration (TSC) as illustrated in the response time/throughput curve on page 13.

In addition, the Average Response Time measured during the 10% Test Run is the value for the SPC-1 LRT™ metric. That value represents the Average Response Time of a lightly loaded TSC.

Clause 9.2.4.7.3

The following content shall appear in the FDR for the Response Time Ramp Phase:

1. A Response Time Ramp Distribution.
2. The human readable Test Run Results File produced by the Workload Generator for each Test Run within the Response Time Ramp Test Phase.
3. For the 10% Load Level Test Run (SPC-1 LRT™ metric) an Average Response Time Distribution.
4. A listing or screen image of all input parameters supplied to the Workload Generator.

SPC-1 Workload Generator Input Parameters

The SPC-1 Workload Generator input parameters for the Sustainability, IOPS, Response Time Ramp, Repeatability, and Persistence Test Runs are documented in “Appendix E: SPC-1 Workload Generator Input Parameters” on Page 68.

Response Time Ramp Test Results File

A link to each test result file generated from each Response Time Ramp Test Run list listed below.

[95% Load Level](#)

[90% Load Level](#)

[80% Load Level](#)

[50% Load Level](#)

[10% Load Level](#)

Response Time Ramp Distribution (IOPS) Data

The five Test Runs that comprise the Response Time Ramp Phase are executed at 95%, 90%, 80%, 50%, and 10% of the Business Scaling Unit (BSU) load level used to produce the SPC-1 IOPS™ primary metric. The 100% BSU load level is included in the following Response Time Ramp data tables and graphs for completeness.

100% Load Level - 180 BSUs					95% Load Level - 171 BSUs				
Start	Stop	Interval	Duration		Start	Stop	Interval	Duration	
12:20:39	12:25:40	0-4	0:05:01		12:35:41	12:40:42	0-4	0:05:01	
12:25:40	12:35:40	5-14	0:10:00		12:40:42	12:50:42	5-14	0:10:00	
<i>(60 second intervals)</i>					<i>(60 second intervals)</i>				
All ASUs	ASU-1	ASU-2	ASU-3		All ASUs	ASU-1	ASU-2	ASU-3	
0	9,005.18	5,370.52	1,110.77	2,523.90	0	8,532.27	5,084.82	1,055.97	2,391.48
1	9,004.15	5,370.68	1,116.73	2,516.73	1	8,557.15	5,107.47	1,050.63	2,399.05
2	9,008.07	5,374.82	1,105.15	2,528.10	2	8,536.87	5,082.82	1,054.97	2,399.08
3	8,983.60	5,366.65	1,103.12	2,513.83	3	8,562.30	5,113.70	1,059.62	2,388.98
4	9,023.33	5,381.27	1,106.30	2,535.77	4	8,534.75	5,087.70	1,048.48	2,398.57
5	9,031.90	5,389.73	1,105.32	2,536.85	5	8,547.18	5,099.82	1,048.33	2,399.03
6	9,015.00	5,381.58	1,107.68	2,525.73	6	8,550.28	5,091.52	1,055.33	2,403.43
7	9,011.25	5,363.97	1,110.25	2,537.03	7	8,551.57	5,099.85	1,056.62	2,395.10
8	8,998.18	5,352.87	1,117.08	2,528.23	8	8,548.87	5,100.80	1,049.22	2,398.85
9	8,988.97	5,363.27	1,103.37	2,522.33	9	8,548.93	5,092.55	1,052.97	2,403.42
10	9,006.88	5,371.10	1,106.50	2,529.28	10	8,573.42	5,117.38	1,053.38	2,402.65
11	8,989.07	5,358.80	1,104.68	2,525.58	11	8,549.47	5,095.33	1,049.45	2,404.68
12	8,995.75	5,367.07	1,108.88	2,519.80	12	8,557.27	5,104.42	1,053.02	2,399.83
13	8,998.25	5,365.43	1,109.40	2,523.42	13	8,554.45	5,101.83	1,053.25	2,399.37
14	8,973.55	5,345.52	1,105.47	2,522.57	14	8,551.38	5,080.32	1,054.28	2,416.78
Average	9,000.88	5,365.93	1,107.86	2,527.08	Average	8,553.28	5,098.38	1,052.59	2,402.32
90% Load Level - 162 BSUs					80% Load Level - 144 BSUs				
Start	Stop	Interval	Duration		Start	Stop	Interval	Duration	
12:50:43	12:55:44	0-4	0:05:01		13:05:45	13:10:46	0-4	0:05:01	
12:55:44	13:05:44	5-14	0:10:00		13:10:46	13:20:46	5-14	0:10:00	
<i>(60 second intervals)</i>					<i>(60 second intervals)</i>				
All ASUs	ASU-1	ASU-2	ASU-3		All ASUs	ASU-1	ASU-2	ASU-3	
0	8,133.52	4,855.37	994.40	2,283.75	0	7,199.53	4,296.73	882.25	2,020.55
1	8,097.28	4,830.15	1,001.50	2,265.63	1	7,181.70	4,264.77	889.15	2,027.78
2	8,068.92	4,812.18	991.77	2,264.97	2	7,209.83	4,295.98	890.82	2,023.03
3	8,078.77	4,821.28	990.22	2,267.27	3	7,216.08	4,296.33	886.35	2,033.40
4	8,103.33	4,826.22	1,000.97	2,276.15	4	7,203.22	4,304.63	885.33	2,013.25
5	8,107.12	4,831.93	995.33	2,279.85	5	7,184.63	4,288.42	880.83	2,015.38
6	8,096.63	4,833.83	984.83	2,277.97	6	7,195.65	4,279.32	884.80	2,031.53
7	8,110.97	4,838.48	998.12	2,274.37	7	7,220.30	4,302.55	890.93	2,026.82
8	8,102.37	4,829.83	994.05	2,278.48	8	7,208.37	4,307.88	881.22	2,019.27
9	8,113.92	4,839.18	1,002.20	2,272.53	9	7,200.50	4,288.92	887.07	2,024.52
10	8,096.77	4,823.03	995.68	2,278.05	10	7,205.63	4,293.43	885.12	2,027.08
11	8,107.97	4,827.20	997.23	2,283.53	11	7,192.23	4,280.73	891.30	2,020.20
12	8,116.22	4,832.15	998.03	2,286.03	12	7,194.47	4,299.25	879.82	2,015.40
13	8,088.07	4,817.42	996.25	2,274.40	13	7,188.85	4,285.32	881.18	2,022.35
14	8,113.92	4,839.48	998.08	2,276.35	14	7,202.70	4,288.45	882.47	2,031.78
Average	8,105.39	4,831.26	995.98	2,278.16	Average	7,199.33	4,291.43	884.47	2,023.43
50% Load Level - 90 BSUs					10% Load Level - 18 BSUs				
Start	Stop	Interval	Duration		Start	Stop	Interval	Duration	
13:20:47	13:25:48	0-4	0:05:01		13:35:49	13:40:50	0-4	0:05:01	
13:25:48	13:35:48	5-14	0:10:00		13:40:50	13:50:50	5-14	0:10:00	
<i>(60 second intervals)</i>					<i>(60 second intervals)</i>				
All ASUs	ASU-1	ASU-2	ASU-3		All ASUs	ASU-1	ASU-2	ASU-3	
0	4,492.75	2,682.62	550.67	1,259.47	0	897.57	535.87	109.92	251.78
1	4,509.25	2,695.97	553.53	1,259.75	1	901.35	538.23	112.35	250.77
2	4,498.10	2,678.30	553.32	1,266.48	2	900.85	536.17	111.82	252.87
3	4,492.03	2,680.48	550.25	1,261.30	3	899.17	536.65	110.70	251.82
4	4,500.22	2,679.27	555.30	1,265.65	4	899.60	540.13	110.52	248.95
5	4,510.30	2,689.67	552.27	1,268.37	5	893.55	533.67	109.98	249.90
6	4,489.72	2,670.48	557.45	1,261.78	6	899.20	532.27	111.02	255.92
7	4,489.27	2,675.65	552.12	1,261.50	7	904.27	540.22	109.83	254.22
8	4,500.95	2,683.72	550.97	1,266.27	8	904.38	537.63	110.33	256.42
9	4,504.68	2,693.35	553.70	1,257.63	9	905.42	541.30	110.98	253.13
10	4,494.40	2,675.47	556.63	1,262.30	10	898.53	535.25	111.47	251.82
11	4,507.98	2,685.23	558.13	1,264.62	11	895.90	535.98	108.38	251.53
12	4,506.65	2,688.57	551.47	1,266.62	12	899.03	535.50	111.97	251.57
13	4,487.03	2,671.28	553.20	1,262.55	13	896.50	538.63	107.53	250.33
14	4,493.35	2,675.87	554.57	1,262.92	14	897.02	535.93	108.70	252.38
Average	4,498.43	2,680.93	554.05	1,263.46	Average	899.38	536.64	110.02	252.72

Response Time Ramp Distribution (IOPS) Graph

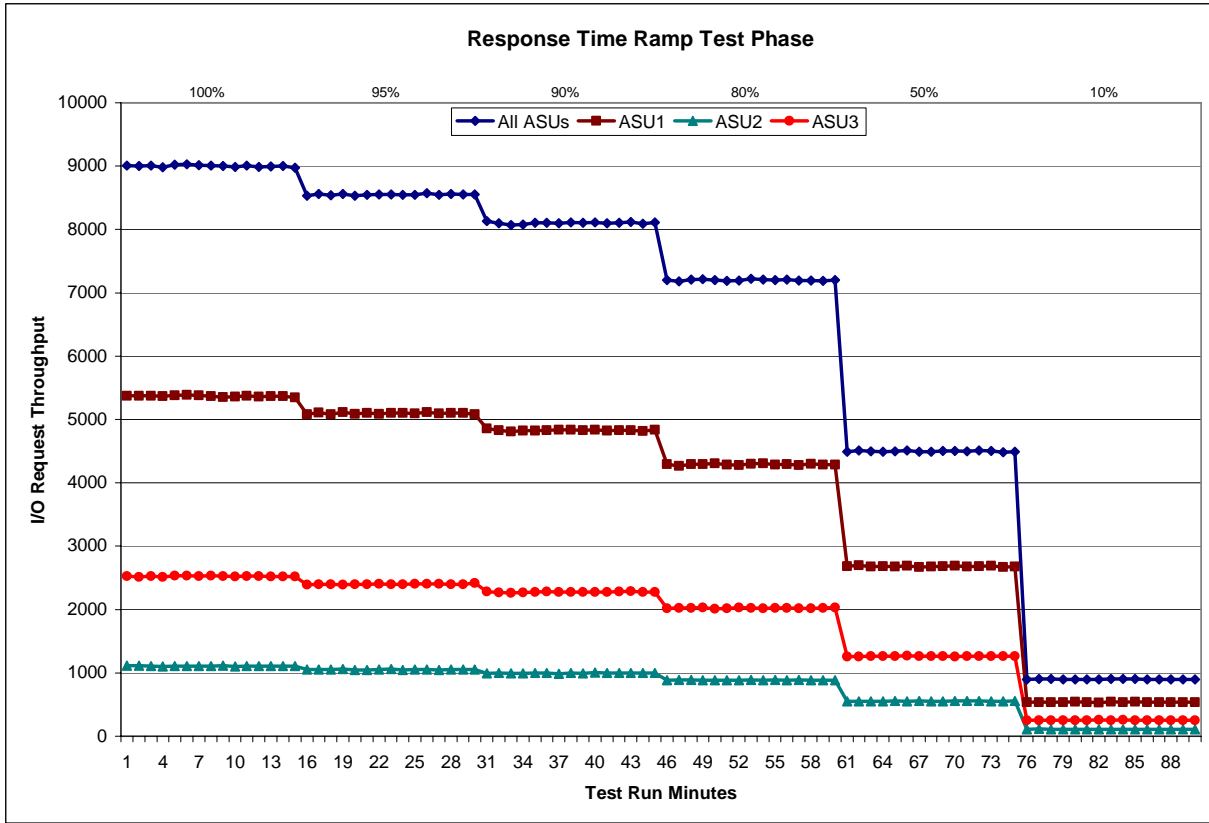

SPC-1 LRT™ Average Response Time (ms) Distribution Data

18 BSUs	Start	Stop	Interval	Duration
<i>Start-Up/Ramp-Up</i>	13:35:49	13:40:50	0-4	0:05:01
<i>Measurement Interval</i>	13:40:50	13:50:50	5-14	0:10:00
60 second intervals	All ASUs	ASU1	ASU2	ASU3
0	2.28	2.91	2.81	0.71
1	2.16	2.73	2.59	0.72
2	2.17	2.75	2.67	0.71
3	2.15	2.71	2.65	0.72
4	2.15	2.72	2.63	0.72
5	2.15	2.72	2.60	0.72
6	2.15	2.74	2.61	0.72
7	2.13	2.71	2.57	0.72
8	2.16	2.74	2.67	0.72
9	2.12	2.69	2.55	0.72
10	2.24	2.86	2.69	0.72
11	2.14	2.71	2.60	0.72
12	2.15	2.72	2.60	0.72
13	2.14	2.71	2.58	0.72
14	2.14	2.72	2.54	0.72
Average	2.15	2.73	2.60	0.72

SPC-1 LRT™ Average Response Time (ms) Distribution Graph

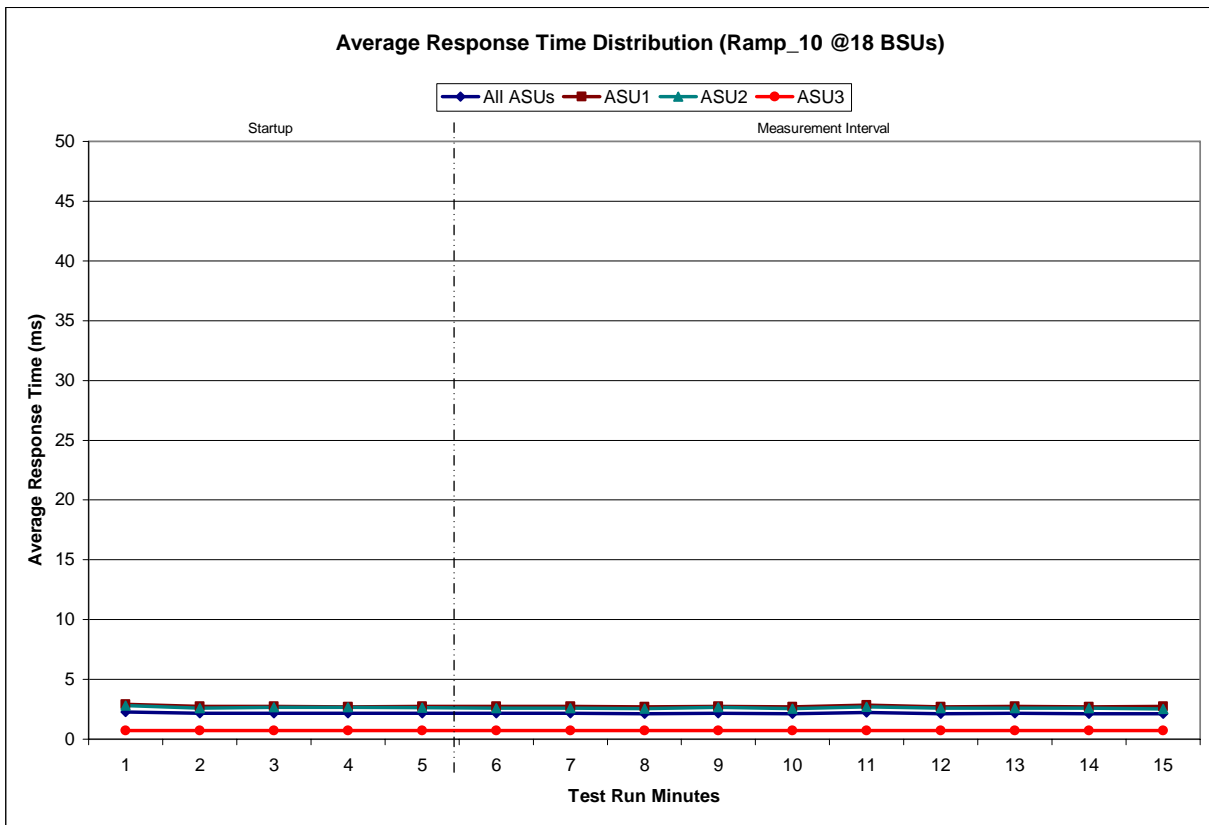

SPC-1 LRT™ (10%) – Measured Intensity Multiplier and Coefficient of Variation

Clause 3.4.3

IM – Intensity Multiplier: The ratio of I/Os for each I/O stream relative to the total I/Os for all I/O streams (ASU1-1 – ASU3-1) as required by the benchmark specification.

Clauses 5.1.0 and 5.3.13.2

MIM – Measured Intensity Multiplier: The Measured Intensity Multiplier represents the ratio of measured I/Os for each I/O stream relative to the total I/Os measured for all I/O streams (ASU1-1 – ASU3-1). This value may differ from the corresponding Expected Intensity Multiplier by no more than 5%.

Clause 5.3.13.3

COV – Coefficient of Variation: This measure of variation for the Measured Intensity Multiplier cannot exceed 0.2.

	ASU1-1	ASU1-2	ASU1-3	ASU1-4	ASU2-1	ASU2-2	ASU2-3	ASU3-1
IM	0.0350	0.2810	0.0700	0.2100	0.0180	0.0700	0.0350	0.2810
MIM	0.0349	0.2813	0.0703	0.2102	0.0178	0.0696	0.0350	0.2810
COV	0.021	0.005	0.016	0.007	0.033	0.014	0.020	0.006

Repeatability Test

Clause 5.4.5

The Repeatability Test demonstrates the repeatability and reproducibility of the SPC-1 IOPS™ primary metric and SPC-1 LRT™ metric generated in earlier Test Runs.

There are two identical Repeatability Test Phases. Each Test Phase contains two Test Runs. Each of the Test Runs will have a Measurement Interval of no less than ten (10) minutes. The two Test Runs in each Test Phase will be executed without interruption or any type of manual intervention.

The first Test Run in each Test Phase is executed at the 10% load point. The Average Response Time from each of the Test Runs is compared to the SPC-1 LRT™ metric. Each Average Response Time value must be less than the SPC-1 LRT™ metric plus 5%.

The second Test Run in each Test Phase is executed at the 100% load point. The I/O Request Throughput from the Test Runs is compared to the SPC-1 IOPS™ primary metric. Each I/O Request Throughput value must be greater than the SPC-1 IOPS™ primary metric minus 5%. In addition, the Average Response Time for each Test Run cannot exceed 30 milliseconds.

If any of the above constraints are not met, the benchmark measurement is invalid.

Clause 9.2.4.7.4

The following content shall appear in the FDR for each Test Run in the two Repeatability Test Phases:

- 1. A table containing the results of the Repeatability Test.*
- 2. An I/O Request Throughput Distribution graph and table.*
- 3. An Average Response Time Distribution graph and table.*
- 4. The human readable Test Run Results File produced by the Workload Generator.*
- 5. A listing or screen image of all input parameters supplied to the Workload Generator.*

SPC-1 Workload Generator Input Parameters

The SPC-1 Workload Generator input parameters for the Sustainability, IOPS, Response Time Ramp, Repeatability, and Persistence Test Runs are documented in “Appendix E: SPC-1 Workload Generator Input Parameters” on Page 68.

Repeatability Test Results File

The values for the SPC-1 IOPS™, SPC-1 LRT™, and the Repeatability Test measurements are listed below.

	SPC-1 IOPS™	SPC-1 LRT™
<i>Primary Metrics</i>	9,000.88	2.15
Repeatability Test Phase 1	9,000.19	2.15
Repeatability Test Phase 2	9,005.97	2.16

A link to the test result file generated from each Repeatability Test Run list is listed below.

[Repeatability Test Phase 1, Test Run 1 \(LRT\)](#)

[Repeatability Test Phase 1, Test Run 2 \(IOPS\)](#)

[Repeatability Test Phase 2, Test Run 1 \(LRT\)](#)

[Repeatability Test Phase 2, Test Run 2 \(IOPS\)](#)

Repeatability 1 LRT - I/O Request Throughput Distribution Data

18 BSUs	Start	Stop	Interval	Duration
<i>Start-Up/Ramp-Up</i>	13:50:56	13:55:56	0-4	0:05:00
<i>Measurement Interval</i>	13:55:56	14:05:56	3-14	0:10:00
60 second intervals	All ASUs	ASU1	ASU2	ASU3
0	903.18	538.38	110.67	254.13
1	898.27	532.50	112.70	253.07
2	899.93	540.60	109.00	250.33
3	907.40	538.75	112.60	256.05
4	895.82	537.07	108.80	249.95
5	897.23	533.83	109.15	254.25
6	906.87	543.87	111.15	251.85
7	904.28	539.22	110.35	254.72
8	898.43	534.00	109.57	254.87
9	904.13	537.53	112.72	253.88
10	897.20	536.32	109.93	250.95
11	893.10	534.28	109.98	248.83
12	896.30	530.52	111.32	254.47
13	906.23	541.82	111.90	252.52
14	903.68	537.65	109.85	256.18
Average	900.75	536.90	110.59	253.25

Repeatability 1 LRT - I/O Request Throughput Distribution Graph

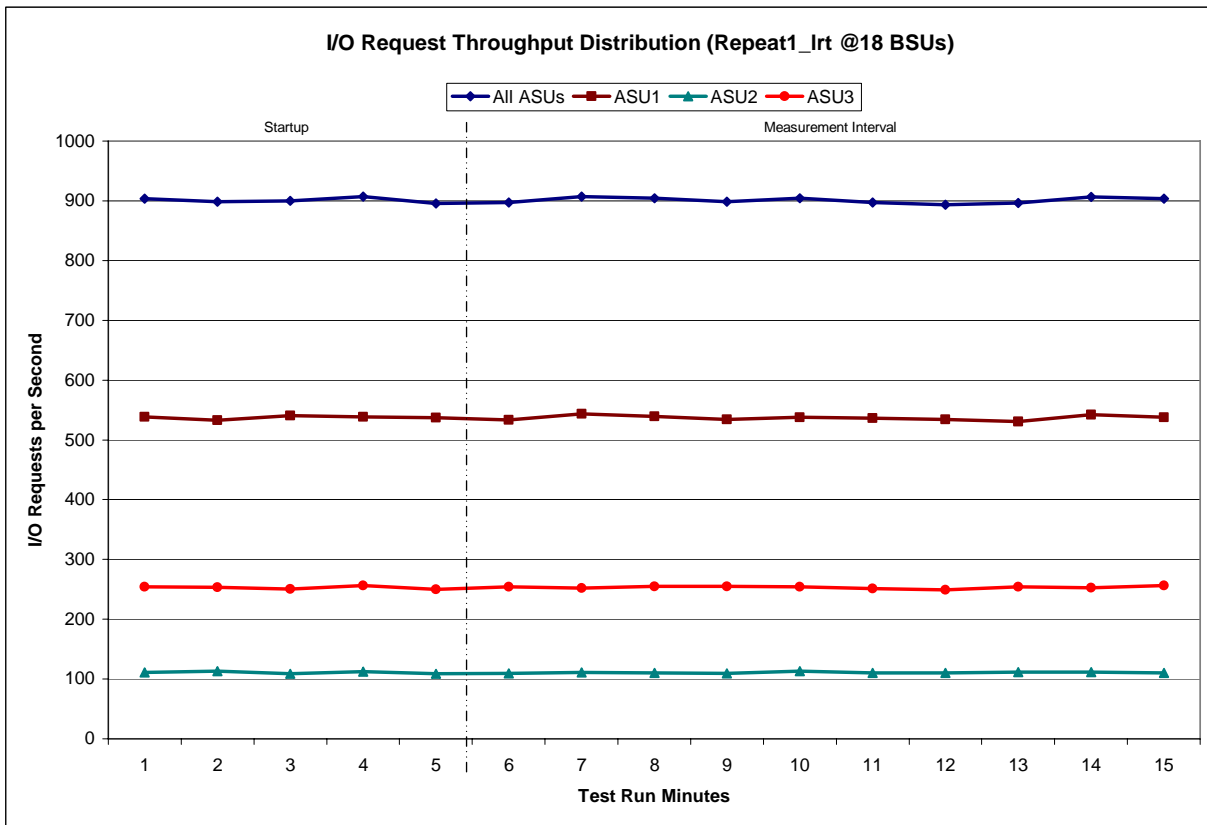

Repeatability 1 LRT –Average Response Time (ms) Distribution Data

18 BSUs	Start	Stop	Interval	Duration
<i>Start-Up/Ramp-Up</i>	13:50:56	13:55:56	0-4	0:05:00
<i>Measurement Interval</i>	13:55:56	14:05:56	3-14	0:10:00
60 second intervals	All ASUs	ASU1	ASU2	ASU3
0	2.15	2.75	2.53	0.71
1	2.16	2.74	2.64	0.72
2	2.18	2.76	2.64	0.72
3	2.16	2.74	2.62	0.72
4	2.22	2.84	2.62	0.72
5	2.16	2.74	2.64	0.72
6	2.15	2.72	2.61	0.72
7	2.15	2.73	2.58	0.72
8	2.12	2.70	2.53	0.71
9	2.17	2.75	2.66	0.72
10	2.14	2.71	2.59	0.71
11	2.15	2.73	2.58	0.72
12	2.15	2.75	2.57	0.71
13	2.16	2.75	2.58	0.72
14	2.20	2.81	2.68	0.72
Average	2.15	2.74	2.60	0.72

Repeatability 1 LRT –Average Response Time (ms) Distribution Graph

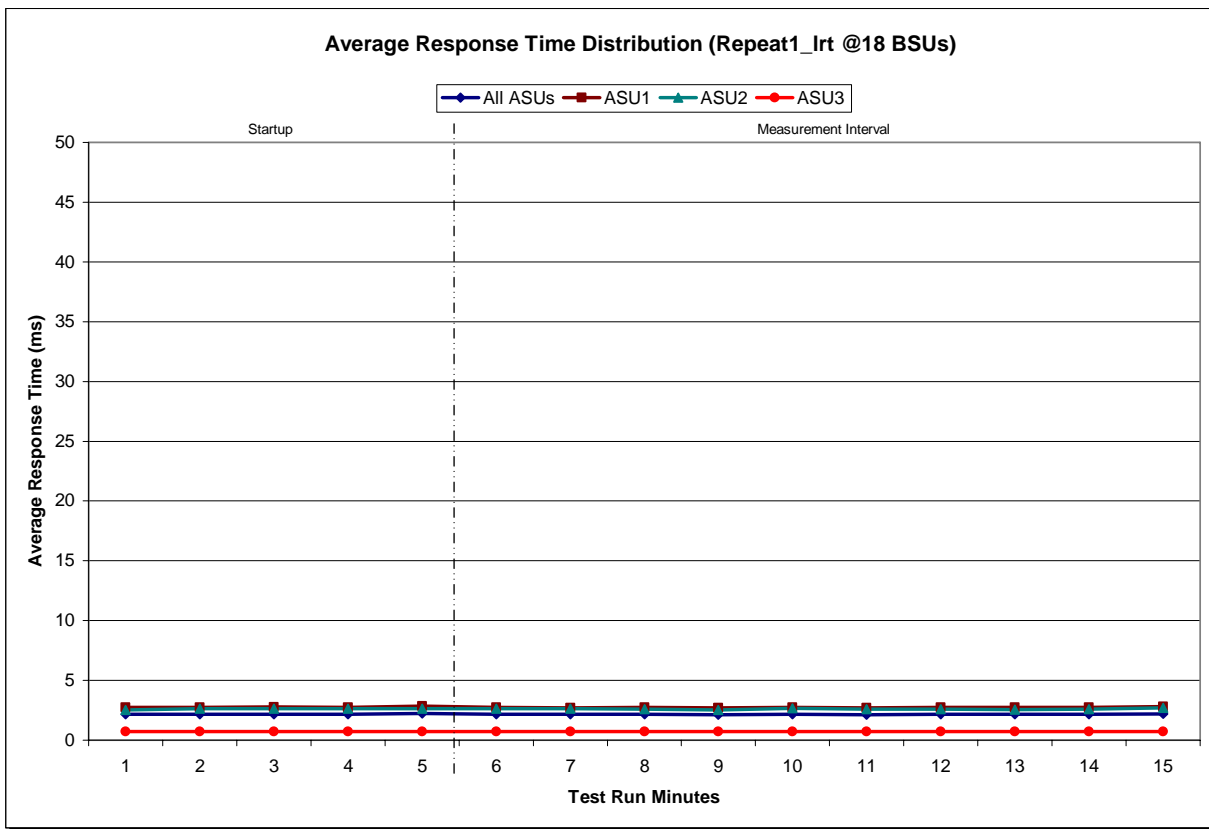

Repeatability 1 IOPS - I/O Request Throughput Distribution Data

180 BSUs	Start	Stop	Interval	Duration
<i>Start-Up/Ramp-Up</i>	14:05:58	14:10:59	0-4	0:05:01
<i>Measurement Interval</i>	14:10:59	14:20:59	3-14	0:10:00
60 second intervals	All ASUs	ASU1	ASU2	ASU3
0	9,003.90	5,369.55	1,113.90	2,520.45
1	9,022.12	5,377.10	1,113.18	2,531.83
2	8,986.67	5,365.48	1,106.78	2,514.40
3	8,990.50	5,359.27	1,108.20	2,523.03
4	8,995.27	5,362.00	1,111.03	2,522.23
5	9,005.07	5,369.02	1,107.20	2,528.85
6	9,018.37	5,375.10	1,114.62	2,528.65
7	8,981.75	5,348.37	1,104.78	2,528.60
8	8,997.42	5,358.92	1,111.08	2,527.42
9	8,983.80	5,357.05	1,103.13	2,523.62
10	9,011.35	5,373.83	1,106.30	2,531.22
11	9,008.75	5,363.90	1,106.98	2,537.87
12	9,000.58	5,367.57	1,104.37	2,528.65
13	9,007.75	5,372.80	1,102.95	2,532.00
14	8,987.02	5,350.67	1,114.30	2,522.05
Average	9,000.19	5,363.72	1,107.57	2,528.89

Repeatability 1 IOPS - I/O Request Throughput Distribution Graph

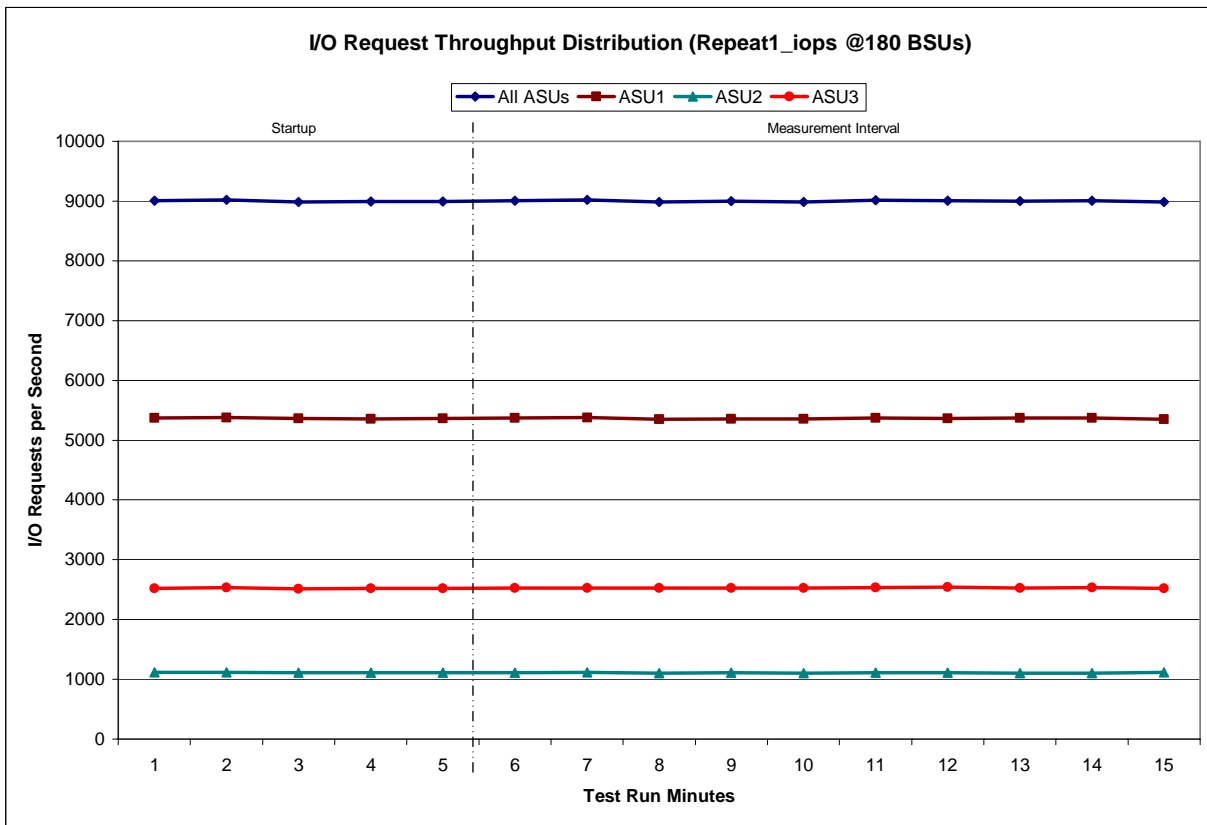

Repeatability 1 IOPS –Average Response Time (ms) Distribution Data

180 BSUs	Start	Stop	Interval	Duration
<i>Start-Up/Ramp-Up</i>	14:05:58	14:10:59	0-4	0:05:01
<i>Measurement Interval</i>	14:10:59	14:20:59	3-14	0:10:00

60 second intervals	All ASUs	ASU1	ASU2	ASU3
0	9.42	10.38	18.70	3.28
1	9.64	10.62	19.15	3.36
2	9.45	10.43	18.85	3.25
3	9.63	10.55	19.15	3.49
4	9.77	10.73	19.06	3.64
5	9.57	10.52	19.20	3.32
6	9.69	10.64	19.58	3.33
7	9.64	10.57	19.26	3.46
8	9.64	10.63	18.95	3.43
9	9.65	10.62	19.16	3.44
10	9.69	10.64	19.69	3.32
11	9.70	10.64	19.36	3.52
12	9.75	10.72	19.36	3.49
13	9.71	10.64	19.29	3.56
14	9.87	10.73	19.52	3.79
Average	9.69	10.63	19.34	3.47

Repeatability 1 IOPS –Average Response Time (ms) Distribution Graph

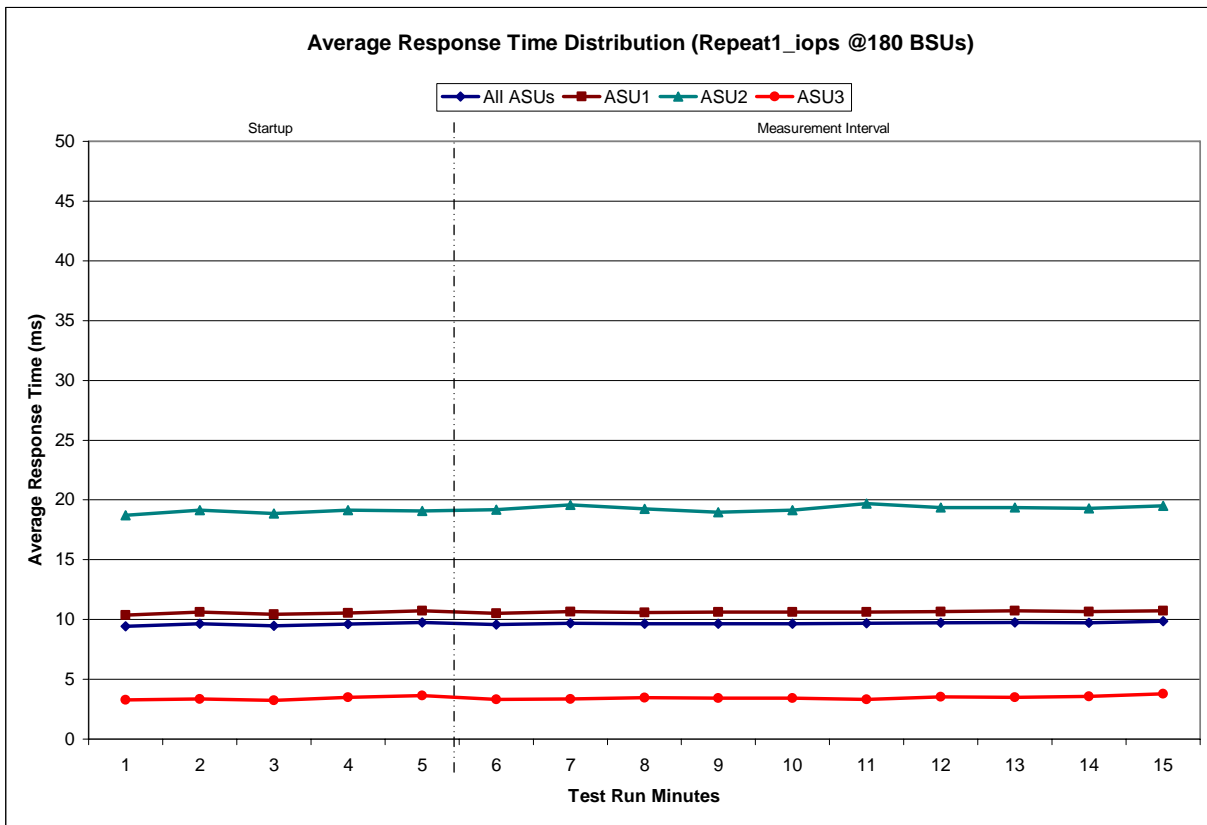

Repeatability 2 LRT - I/O Request Throughput Distribution Data

18 BSUs	Start	Stop	Interval	Duration
<i>Start-Up/Ramp-Up</i>	14:21:05	14:26:05	0-4	0:05:00
<i>Measurement Interval</i>	14:26:05	14:36:05	3-14	0:10:00
60 second intervals	All ASUs	ASU1	ASU2	ASU3
0	906.08	541.83	111.37	252.88
1	900.30	539.77	111.32	249.22
2	897.98	535.82	108.80	253.37
3	904.37	541.98	110.95	251.43
4	896.27	538.42	108.70	249.15
5	896.18	532.98	109.38	253.82
6	901.03	538.07	111.03	251.93
7	899.37	533.83	111.18	254.35
8	901.03	535.93	111.58	253.52
9	898.60	531.57	110.88	256.15
10	907.93	540.03	113.40	254.50
11	899.08	536.67	111.57	250.85
12	903.23	537.33	111.37	254.53
13	901.28	535.52	110.08	255.68
14	902.17	536.22	112.62	253.33
Average	900.99	535.82	111.31	253.87

Repeatability 2 LRT - I/O Request Throughput Distribution Graph

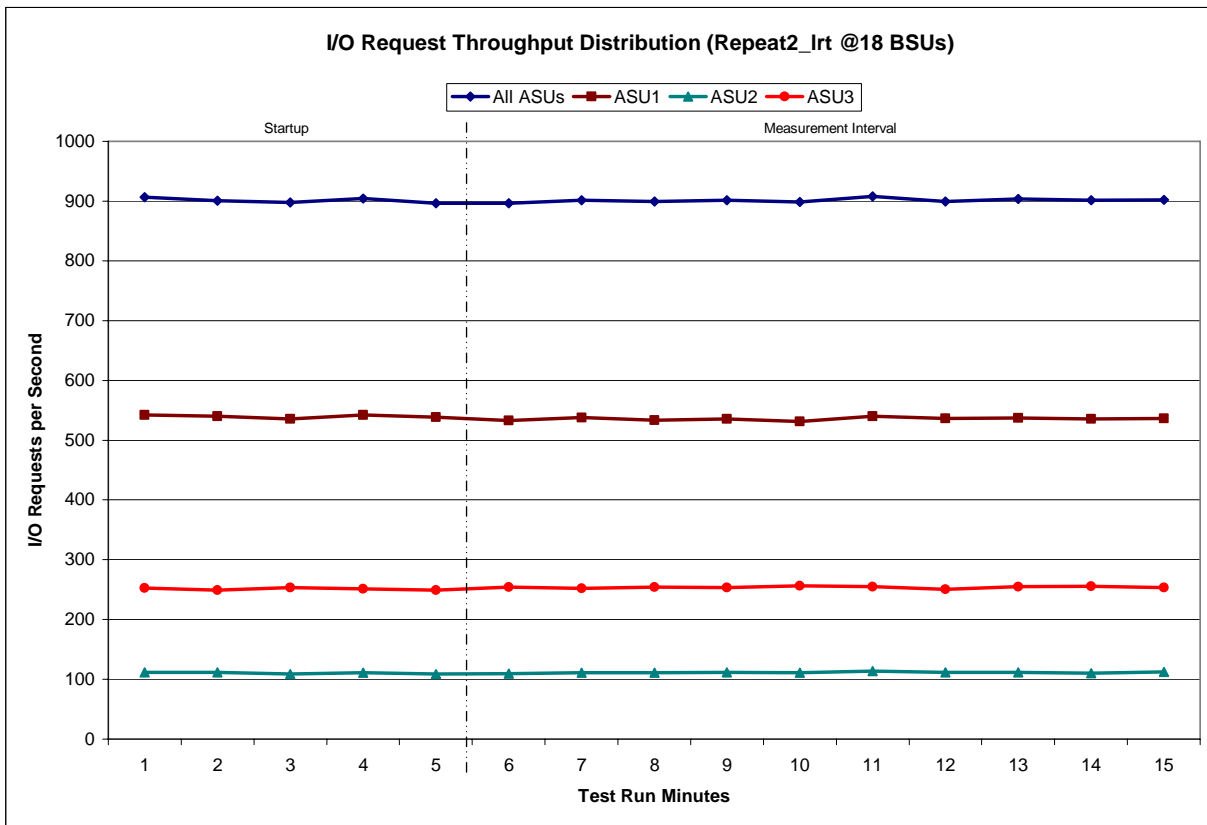

Repeatability 2 LRT –Average Response Time (ms) Distribution Data

18 BSUs	Start	Stop	Interval	Duration
<i>Start-Up/Ramp-Up</i>	14:21:05	14:26:05	0-4	0:05:00
<i>Measurement Interval</i>	14:26:05	14:36:05	3-14	0:10:00
60 second intervals	All ASUs	ASU1	ASU2	ASU3
0	2.24	2.86	2.72	0.72
1	2.16	2.72	2.64	0.72
2	2.16	2.74	2.66	0.72
3	2.14	2.72	2.52	0.72
4	2.17	2.75	2.62	0.71
5	2.15	2.73	2.60	0.72
6	2.13	2.72	2.50	0.72
7	2.14	2.72	2.62	0.72
8	2.15	2.74	2.55	0.71
9	2.24	2.89	2.62	0.72
10	2.14	2.72	2.60	0.72
11	2.15	2.72	2.59	0.72
12	2.14	2.71	2.64	0.72
13	2.14	2.72	2.63	0.72
14	2.18	2.77	2.70	0.72
Average	2.16	2.75	2.60	0.72

Repeatability 2 LRT –Average Response Time (ms) Distribution Graph

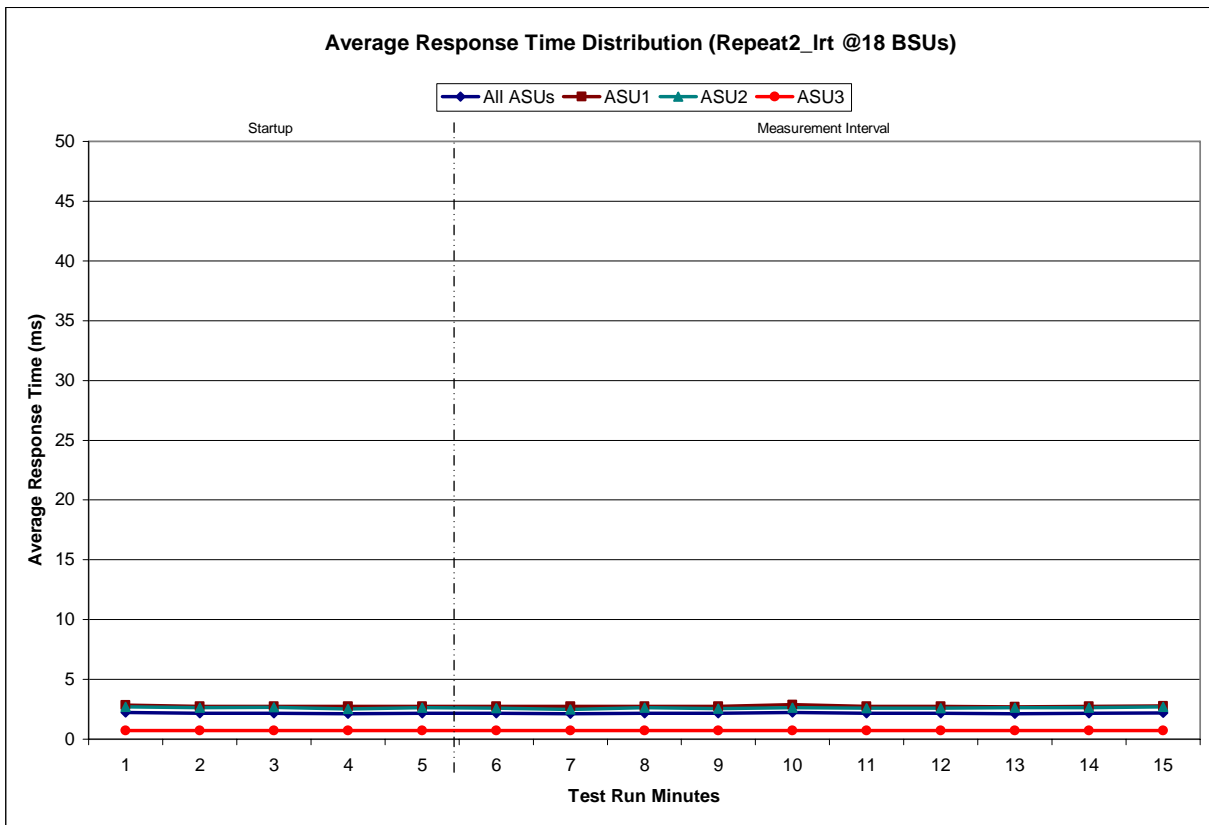

Repeatability 2 IOPS - I/O Request Throughput Distribution Data

180 BSUs	Start	Stop	Interval	Duration
<i>Start-Up/Ramp-Up</i>	14:36:07	14:41:08	0-4	0:05:01
<i>Measurement Interval</i>	14:41:08	14:51:08	3-14	0:10:00
60 second intervals	All ASUs	ASU1	ASU2	ASU3
0	9,028.48	5,380.67	1,108.62	2,539.20
1	8,976.53	5,352.70	1,105.77	2,518.07
2	9,005.55	5,375.87	1,106.17	2,523.52
3	8,998.33	5,361.30	1,100.12	2,536.92
4	8,993.37	5,364.52	1,102.57	2,526.28
5	9,005.23	5,368.52	1,109.13	2,527.58
6	8,999.77	5,363.08	1,103.35	2,533.33
7	9,018.52	5,373.35	1,110.25	2,534.92
8	8,981.62	5,354.35	1,106.97	2,520.30
9	8,995.58	5,363.07	1,108.18	2,524.33
10	9,026.98	5,380.72	1,108.75	2,537.52
11	9,010.13	5,374.83	1,101.27	2,534.03
12	9,011.38	5,369.62	1,105.90	2,535.87
13	9,004.78	5,373.00	1,104.87	2,526.92
14	9,005.73	5,359.80	1,108.88	2,537.05
Average	9,005.97	5,368.03	1,106.76	2,531.19

Repeatability 2 IOPS - I/O Request Throughput Distribution Graph

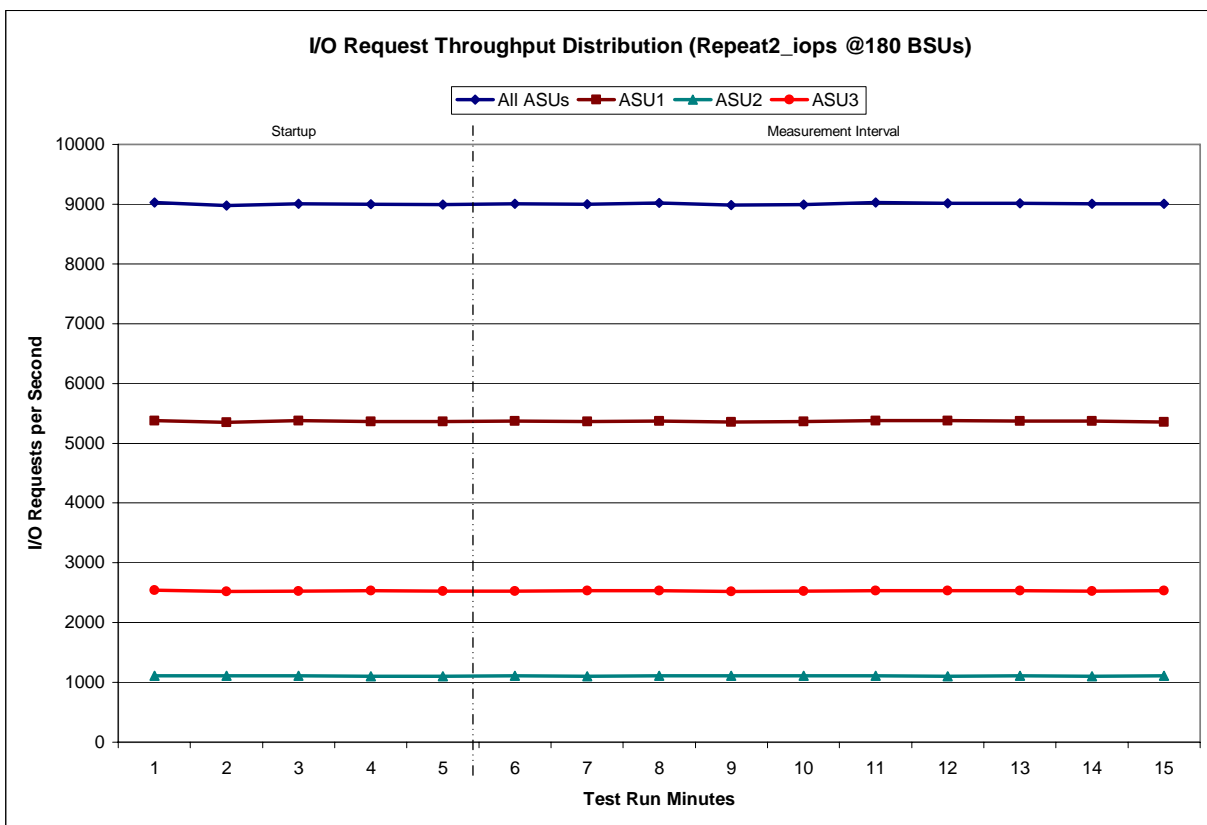

Repeatability 2 IOPS –Average Response Time (ms) Distribution Data

180 BSUs	Start	Stop	Interval	Duration
<i>Start-Up/Ramp-Up</i>	14:36:07	14:41:08	0-4	0:05:01
<i>Measurement Interval</i>	14:41:08	14:51:08	3-14	0:10:00
60 second intervals	All ASUs	ASU1	ASU2	ASU3
0	9.55	10.49	18.98	3.44
1	9.60	10.54	19.31	3.34
2	9.55	10.53	19.20	3.25
3	9.78	10.74	19.27	3.65
4	9.59	10.55	19.09	3.39
5	10.04	10.90	19.85	3.90
6	9.64	10.61	19.23	3.43
7	9.59	10.54	19.52	3.24
8	9.68	10.61	19.21	3.50
9	9.53	10.50	19.09	3.27
10	9.78	10.69	19.70	3.51
11	9.59	10.58	19.31	3.26
12	9.63	10.57	19.45	3.35
13	9.59	10.56	19.25	3.31
14	9.65	10.60	19.45	3.37
Average	9.67	10.62	19.41	3.41

Repeatability 2 IOPS –Average Response Time (ms) Distribution Graph

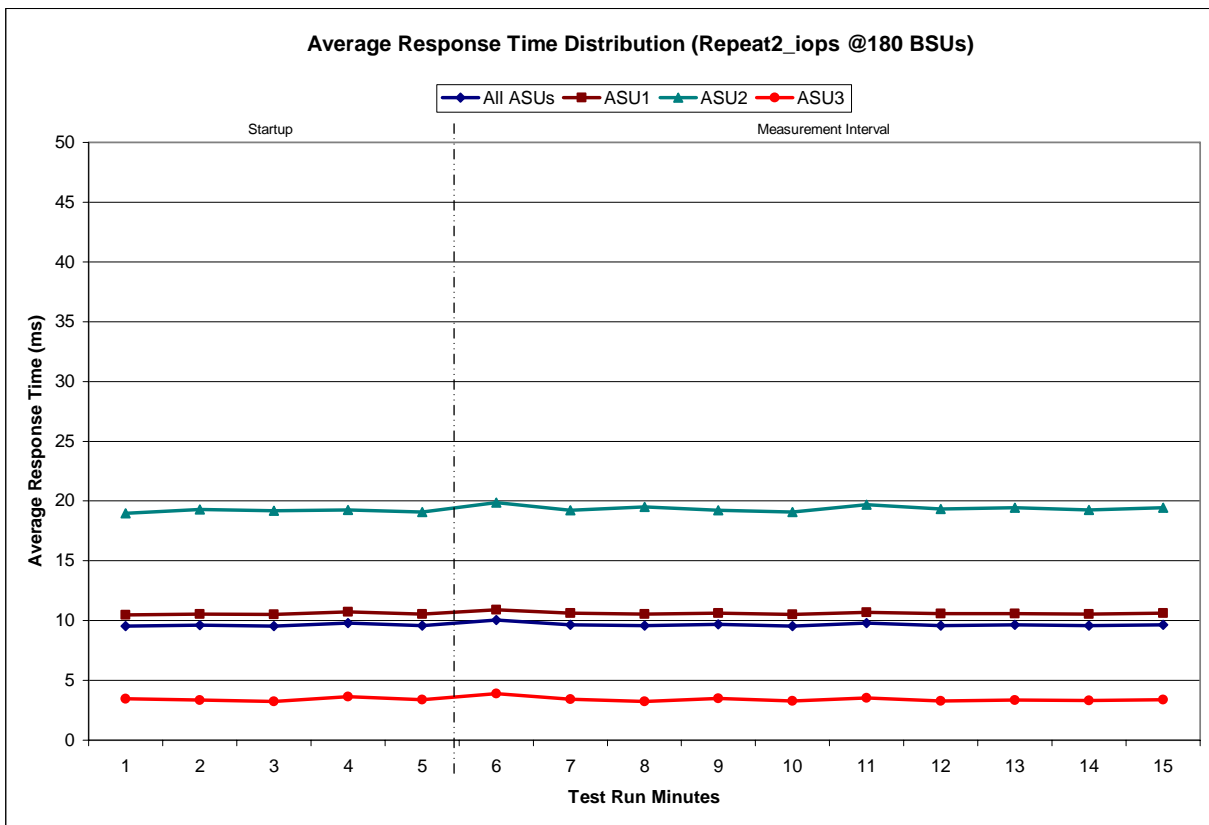

Repeatability 1 (LRT)
Measured Intensity Multiplier and Coefficient of Variation

Clause 3.4.3

IM – Intensity Multiplier: The ratio of I/Os for each I/O stream relative to the total I/Os for all I/O streams (ASU1-1 – ASU3-1) as required by the benchmark specification.

Clauses 5.1.0 and 5.3.13.2

MIM – Measured Intensity Multiplier: The Measured Intensity Multiplier represents the ratio of measured I/Os for each I/O stream relative to the total I/Os measured for all I/O streams (ASU1-1 – ASU3-1). This value may differ from the corresponding Expected Intensity Multiplier by no more than 5%.

Clause 5.3.13.3

COV – Coefficient of Variation: This measure of variation for the Measured Intensity Multiplier cannot exceed 0.2.

	ASU1-1	ASU1-2	ASU1-3	ASU1-4	ASU2-1	ASU2-2	ASU2-3	ASU3-1
IM	0.0350	0.2810	0.0700	0.2100	0.0180	0.0700	0.0350	0.2810
MIM	0.0348	0.2813	0.0701	0.2098	0.0179	0.0698	0.0351	0.2812
COV	0.020	0.007	0.013	0.006	0.035	0.018	0.023	0.008

Repeatability 1 (IOPS)
Measured Intensity Multiplier and Coefficient of Variation

	ASU1-1	ASU1-2	ASU1-3	ASU1-4	ASU2-1	ASU2-2	ASU2-3	ASU3-1
IM	0.0350	0.2810	0.0700	0.2100	0.0180	0.0700	0.0350	0.2810
MIM	0.0351	0.2808	0.0700	0.2100	0.0180	0.0701	0.0349	0.2810
COV	0.010	0.002	0.005	0.002	0.011	0.006	0.009	0.001

Repeatability 2 (LRT)
Measured Intensity Multiplier and Coefficient of Variation

	ASU1-1	ASU1-2	ASU1-3	ASU1-4	ASU2-1	ASU2-2	ASU2-3	ASU3-1
IM	0.0350	0.2810	0.0700	0.2100	0.0180	0.0700	0.0350	0.2810
MIM	0.0349	0.2806	0.0700	0.2092	0.0181	0.0704	0.0350	0.2818
COV	0.017	0.007	0.019	0.006	0.036	0.017	0.021	0.007

Repeatability 2 (IOPS)
Measured Intensity Multiplier and Coefficient of Variation

	ASU1-1	ASU1-2	ASU1-3	ASU1-4	ASU2-1	ASU2-2	ASU2-3	ASU3-1
<i>IM</i>	<i>0.0350</i>	<i>0.2810</i>	<i>0.0700</i>	<i>0.2100</i>	<i>0.0180</i>	<i>0.0700</i>	<i>0.0350</i>	<i>0.2810</i>
MIM	0.0351	0.2809	0.0700	0.2101	0.0181	0.0699	0.0349	0.2811
COV	0.005	0.002	0.007	0.002	0.009	0.004	0.005	0.001

Data Persistence Test

Clause 6

The Data Persistence Test demonstrates the Tested Storage Configuration (TSC):

- *Is capable of maintain data integrity across a power cycle.*
- *Ensures the transfer of data between Logical Volumes and host systems occurs without corruption or loss.*

The SPC-1 Workload Generator will write 16 block I/O requests at random over the total Addressable Storage Capacity of the TSC for ten (10) minutes at a minimum of 25% of the load used to generate the SPC-1 IOP™ primary metric. The bit pattern selected to be written to each block as well as the address of the block will be retained in a log file.

The Benchmark Configuration will be shutdown and restarted using a power off/power on cycle at the end of the above sequence of write operations. In addition, any caches employing battery backup must be flushed/emptied.

The SPC-1 Workload Generator will then use the above log file to verify each block written contains the correct bit pattern.

Clause 9.2.4.8

The following content shall appear in this section of the FDR:

1. *A listing or screen image of all input parameters supplied to the Workload Generator.*
2. *For the successful Data Persistence Test Run, a table illustrating key results. The content, appearance, and format of this table are specified in Table 9-12. Information displayed in this table shall be obtained from the Test Run Results File referenced below in #3.*
3. *For the successful Data Persistence Test Run, the human readable Test Run Results File produced by the Workload Generator.*

SPC-1 Workload Generator Input Parameters

The SPC-1 Workload Generator input parameters for the Sustainability, IOPS, Response Time Ramp, Repeatability, and Persistence Test Runs are documented in “Appendix E: SPC-1 Workload Generator Input Parameters” on Page 68.

Data Persistence Test Results File

A link to each test result file generated from each Data Persistence Test is listed below.

[Persistence 1 Test Results File](#)

[Persistence 2 Test Results File](#)

Data Persistence Test Results

Data Persistence Test Results	
Data Persistence Test Run Number: 1	
Total Number of Logical Blocks Written	21,594,096
Total Number of Logical Blocks Verified	19,704,240
Total Number of Logical Blocks that Failed Verification	0
Time Duration for Writing Test Logical Blocks	10 minutes
Size in Bytes of each Logical Block	512
Number of Failed I/O Requests in the process of the Test	0

In some cases the same address was the target of multiple writes, which resulted in more Logical Blocks Written than Logical Blocks Verified. In the case of multiple writes to the same address, the pattern written and verified must be associated with the last write to that address.

PRICED STORAGE CONFIGURATION AVAILABILITY DATE

Clause 9.2.4.9

The committed delivery data for general availability (Availability Date) of all products that comprise the Priced Storage Configuration must be reported. When the Priced Storage Configuration includes products or components with different availability dates, the reported Availability Date must be the date at which all components are committed to be available.

The FDR shall state: "The Priced Storage Configuration, as documented in this Full Disclosure Report will be available for shipment to customers on MMMM DD, YYYY." Where Priced Storage Configuration is the TSC Configuration Name as described in Clause 9.2.4.3.3 and MMMM is the alphanumeric month, DD is the numeric day, and YYYY is the numeric year of the date that the Priced Storage Configuration, as documented, is available for shipment to customers as described above.

The IBM System Storage DS3400 as documented in this Full Disclosure Report is currently available for customer purchase and shipment.

PRICING INFORMATION

Clause 9.2.4.11

A statement of the respective calculations for pricing must be included.

Clause 9.2.4.11.3

A list of all differences between the Tested Storage Configuration (TSC) and Priced Storage Configuration must be included.

Pricing information may found in the Tested Storage Configuration Pricing section on page 14. A list of all differences between the Tested Storage Configuration (TSC) and Priced Storage Configuration may be found in the Executive Summary portion of this document on page 14.

ANOMALIES OR IRREGULARITIES

Clause 9.2.4.10

The FDR shall include a clear and complete description of any anomalies or irregularities encountered in the course of executing the SPC-1 benchmark that may in any way call into question the accuracy, verifiability, or authenticity of information published in this FDR.

There were no anomalies or irregularities encountered during the SPC-1 Remote Audit of the IBM System Storage DS3400.

APPENDIX A: SPC-1 GLOSSARY

“Decimal” (*powers of ten*) Measurement Units

In the storage industry, the terms “kilo”, “mega”, “giga”, “tera”, “peta”, and “exa” are commonly used prefixes for computing performance and capacity. For the purposes of the SPC workload definitions, all of the following terms are defined in “powers of ten” measurement units.

- A kilobyte (KB) is equal to 1,000 (10^3) bytes.
- A megabyte (MB) is equal to 1,000,000 (10^6) bytes.
- A gigabyte (GB) is equal to 1,000,000,000 (10^9) bytes.
- A terabyte (TB) is equal to 1,000,000,000,000 (10^{12}) bytes.
- A petabyte (PB) is equal to 1,000,000,000,000,000 (10^{15}) bytes
- An exabyte (EB) is equal to 1,000,000,000,000,000,000 (10^{18}) bytes

“Binary” (*powers of two*) Measurement Units

The sizes reported by many operating system components use “powers of two” measurement units rather than “power of ten” units. The following standardized definitions and terms are also valid and may be used in this document.

- A kibibyte (KiB) is equal to 1,024 (2^{10}) bytes.
- A mebibyte (MiB) is equal to 1,048,576 (2^{20}) bytes.
- A gibibyte (GiB) is equal to 1,073,741,824 (2^{30}) bytes.
- A tebibyte (TiB) is equal to 1,099,511,627,776 (2^{40}) bytes.
- A pebibyte (PiB) is equal to 1,125,899,906,842,624 (2^{50}) bytes.
- An exbibyte (EiB) is equal to 1,152,921,504,606,846,967 (2^{60}) bytes.

SPC-1 Data Repository Definitions

Total ASU Capacity: The total storage capacity read and written in the course of executing the SPC-1 benchmark.

Application Storage Unit (ASU): The logical interface between the storage and SPC-1 Workload Generator. The three ASUs (Data, User, and Log) are typically implemented on one or more Logical Volume.

Logical Volume: The division of Addressable Storage Capacity into individually addressable logical units of storage used in the SPC-1 benchmark. Each Logical Volume is implemented as a single, contiguous address space.

Addressable Storage Capacity: The total storage (sum of Logical Volumes) that can be read and written by application programs such as the SPC-1 Workload Generator.

Configured Storage Capacity: This capacity includes the Addressable Storage Capacity and any other storage (parity disks, hot spares, etc.) necessary to implement the Addressable Storage Capacity.

Physical Storage Capacity: The formatted capacity of all storage devices physically present in the Tested Storage Configuration (TSC).

Data Protection Overhead: The storage capacity required to implement the selected level of data protection.

Required Storage: The amount of Configured Storage Capacity required to implement the Addressable Storage Configuration, excluding the storage required for the three ASUs.

Global Storage Overhead: The amount of Physical Storage Capacity that is required for storage subsystem use and unavailable for use by application programs.

Total Unused Storage: The amount of storage capacity available for use by application programs but not included in the Total ASU Capacity.

SPC-1 Data Protection Levels

RAID5: User data is distributed across the disks in the array. Check data corresponding to user data is distributed across multiple disks in the form of bit-by-bit parity.

Mirroring: Two or more identical copies of user data are maintained on separate disks.

Other Protection Level: Any data protection other than **RAID5** or **Mirroring**.

Unprotected: There is no data protection provided.

SPC-1 Test Execution Definitions

Average Response Time: The sum of the Response Times for all Measured I/O Requests divided by the total number of Measured I/O Requests.

Completed I/O Request: An I/O Request with a Start Time and a Completion Time (see "I/O Completion Types" below).

Completion Time: The time recorded by the Workload Generator when an I/O Request is satisfied by the TSC as signaled by System Software.

Data Rate: The data transferred in all Measured I/O Requests in an SPC-1 Test Run divided by the length of the Test Run in seconds.

Expected I/O Count: For any given I/O Stream and Test Phase, the product of 50 times the BSU level, the duration of the Test Phase in seconds, and the Intensity Multiplier for that I/O Stream.

Failed I/O Request: Any I/O Request issued by the Workload Generator that could not be completed or was signaled as failed by System Software. A Failed I/O Request has no Completion Time (see “I/O Completion Types” below).

I/O Request Throughput: The total number of Measured I/O requests in an SPC-1 Test Run divided by the duration of the Measurement Interval in seconds.

In-Flight I/O Request: An I/O Request issued by the I/O Command Generator to the TSC that has a recorded Start Time, but does not complete within the Measurement Interval (see “I/O Completion Types” below).

Measured I/O Request: A Completed I/O Request with a Completion Time occurring within the Measurement Interval (see “I/O Completion Types” below).

Measured Intensity Multiplier: The percentage of all Measured I/O Requests that were issued by a given I/O Stream.

Measurement Interval: The finite and contiguous time period, after the TSC has reached Steady State, when data is collected by a Test Sponsor to generate an SPC-1 test result or support an SPC-1 test result.

Ramp-Up: The time required for the Benchmark Configuration (BC) to produce Steady State throughput after the Workload Generator begins submitting I/O Requests to the TSC for execution.

Ramp-Down: The time required for the BC to complete all I/O Requests issued by the Workload Generator. The Ramp-Down period begins when the Workload Generator ceases to issue new I/O Requests to the TSC.

Response Time: The Response Time of a Measured I/O Request is its Completion Time minus its Start Time.

Start Time: The time recorded by the Workload Generator when an I/O Request is submitted, by the Workload Generator, to the System Software for execution on the Tested Storage Configuration (TSC).

Start-Up: The period that begins after the Workload Generator starts to submit I/O requests to the TSC and ends at the beginning of the Measurement Interval.

Shut-Down: The period between the end of the Measurement Interval and the time when all I/O Requests issued by the Workload Generator have completed or failed.

Steady State: The consistent and sustainable throughput of the TSC. During this period the load presented to the TSC by the Workload Generator is constant.

Test: A collection of Test Phases and or Test Runs sharing a common objective.

Test Run: The execution of SPC-1 for the purpose of producing or supporting an SPC-1 test result. SPC-1 Test Runs may have a finite and measured Ramp-Up period, Start-Up

period, Shut-Down period, and Ramp-Down period as illustrated in the “SPC-1 Test Run Components” below. All SPC-1 Test Runs shall have a Steady State period and a Measurement Interval.

Test Phase: A collection of one or more SPC-1 Test Runs sharing a common objective and intended to be run in a specific sequence.

I/O Completion Types

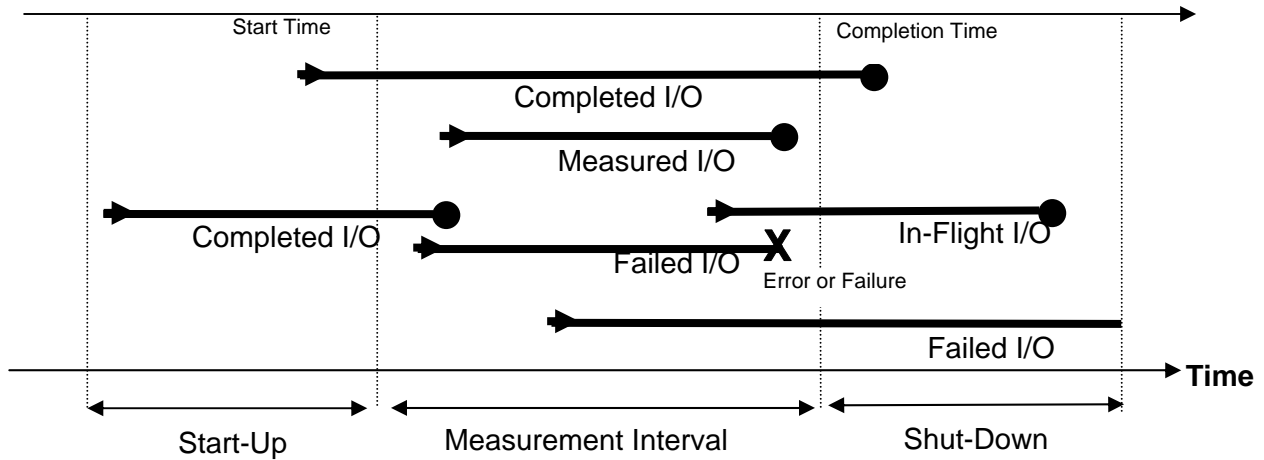

SPC-1 Test Run Components

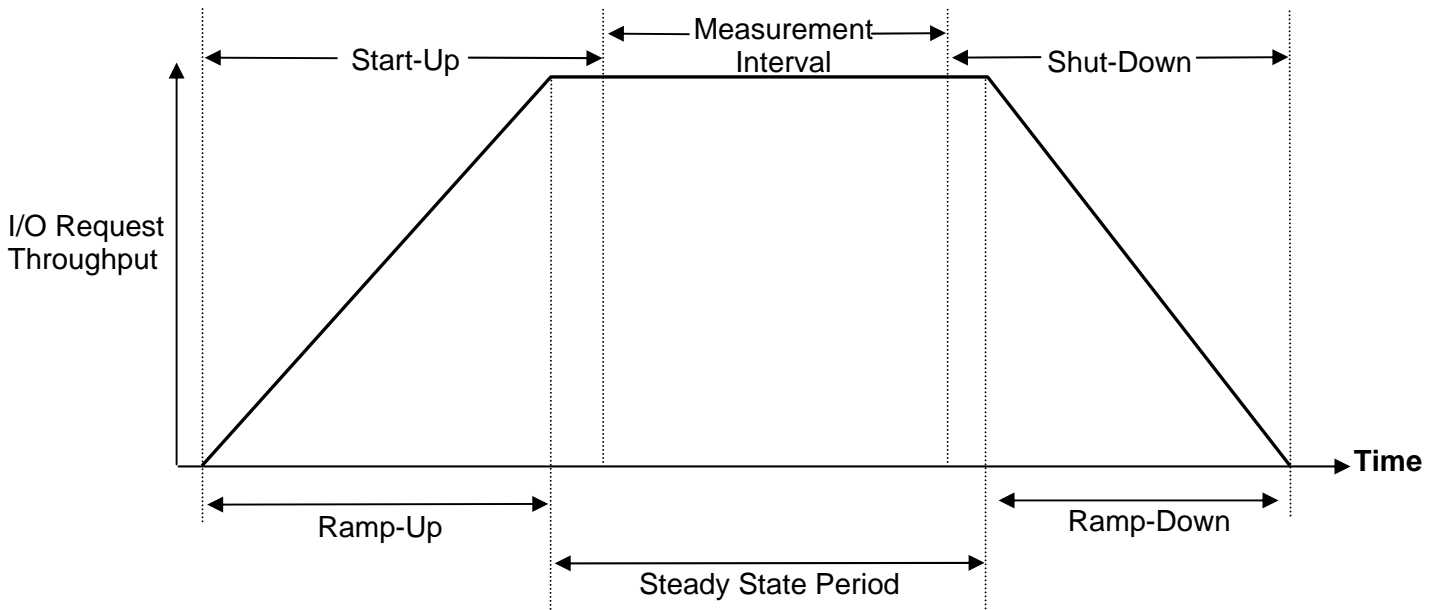

APPENDIX B: CUSTOMER TUNABLE PARAMETERS AND OPTIONS

Windows Server 2003 Registry Changes

```
HKEY_LOCAL_MACHINE\SYSTEM\CurrentControlSet\Services\  
ql2300\Device\MaximumSGList=0xff  
HKEY_LOCAL_MACHINE\SYSTEM\CurrentControlSet\Services\  
ql2300\Device\NumberOfRequests=0xfe  
HKEY_LOCAL_MACHINE\SYSTEM\CurrentControlSet\Services\  
Disk\TimeOutValue=0x78  
HKEY_LOCAL_MACHINE\SYSTEM\CurrentControlSet\Services\  
ql2300\Device\DriverParameters=UseSameNN=1
```

Storage Array Cache Block Size

CacheBlockSize: changed from default of 4K to new value of 16K

Volume Segment Size

SegmentSize: changed from default of 128K to new value of 512K

RDAC Failover Options

Host Region	Offset	Default	New Value
3	0x24	1	0
9	0x24	1	0
10	0x24	1	0
11	0x24	1	0
12	0x24	1	0
13	0x24	1	0
14	0x24	1	0

Host Bus Adapter Options

The table below lists the Host Bus Adapter BIOS options that were changed from their default values.

Host Bus Adapter Settings		
Item	Default	New Value
Adapter Settings:		
Loop Reset Delay	5	8
Adapter Hard Loop ID	Disabled	Enabled
Hard Loop ID (unique for each)	0	eg. 22
Fibre Channel Tape Support	Enabled	Disabled
Advanced Adapter Settings:		
Execution Throttle	16	256
LUNs per Target	8	0
Login Retry Count	8	30
Port Down Retry Count	8	70
Link Down Timeout	30	60

APPENDIX C: TESTED STORAGE CONFIGURATION (TSC) CREATION

The storage management utility, **Simplicity**, was used to create eight volume groups on the storage subsystem, each volume group contains a RAID1 (mirrored) volume. The eight RAID1 volumes are visible by the one attached Host System.

Define Host Access and TSC Configuration

The steps that follow are required to define the Host Access and TSC configuration.

1. Use **Simplicity** to create a host of type “**Windows 2000/Server 2003 Non-Clustered**”, name the host “**bmex346f**”. Specify the HBA Host Ports that correspond to the connected host. Select “**No, This host will NOT share access to the same volumes with other hosts.**”
2. Remove the Access Volume’s Host-to-Volume Mapping.
3. Create Volumes using the **Simplicity** script, “**1932_8_2plus2.script**”, listed below.

Define Windows Partitions, Volumes, and Stripe Sets

The steps that follow are required to define the Windows partitions, volumes, and stripe sets that will be used by the SPC-1 benchmark.

1. Run the attached script **doSPC.bat**, which performs the following steps:
 - Use **diskpar.exe** to set the starting offset for each of the storage system volumes.
 - Starting offset is 65536. Use all of the remaining capacity in the partition.
 - Convert all of the storage system volumes to Dynamic Disks using the “**convertDynamic.script**”.
 - The following steps are done using the “**createVolumes.script**”.
 - Create a Windows Striped (RAID 0) volume using all eight 32MB volumes.
 - Delete the large volume on each of the Dynamic Disks.
 - Create a Windows Striped (RAID 0) volume for ASU 3.
 - Select all eight volumes.
 - Set capacity to 11696MB.
 - Assign drive letter “N” to the volume. Do not format the volume.
 - Create the Windows Striped (RAID0) volume for ASU 1.
 - Select all eight volumes.
 - Set capacity to 52632MB.
 - Assign drive letter “L” to the volume. Do not format the volume.
 - Create the Windows Striped (RAID 0) volume for ASU 2.
 - Select all eight volumes.
 - Set capacity to 52632MB.
 - Assign drive letter “M” to the volume. Do not format the volume.

2. Reboot the Host System.
3. After reboot completes, start Disk Administrator on the Host System.
4. Reactivate the Windows stripe sets as necessary.

1932_8_2plus2.script

```
/* SPC-1 Configuration script */
/* Mary Jane 1932 Controller */
/* 32 Drives 8 2+2 */

/*7/5/2007 - First Version*/

create volume drives[ 0,1 0,2 0,3 0,4 ]
RAIDLevel=1
segmentSize=512
userLabel="LUN_0"
capacity=128gb
owner=A;

create volume drives[ 0,5 0,6 0,7 0,8 ]
RAIDLevel=1
segmentSize=512
userLabel="LUN_1"
capacity=128gb
owner=A;

create volume drives[ 0,9 0,10 0,11 0,12 ]
RAIDLevel=1
segmentSize=512
userLabel="LUN_2"
capacity=128gb
owner=A;

create volume drives[ 1,1 1,2 1,3 1,4 ]
RAIDLevel=1
segmentSize=512
userLabel="LUN_3"
capacity=128gb
owner=A;

create volume drives[ 1,5 1,6 1,7 1,8 ]
RAIDLevel=1
segmentSize=512
userLabel="LUN_4"
capacity=128gb
owner=B;

create volume drives[ 1,9 1,10 1,11 1,12 ]
RAIDLevel=1
segmentSize=512
```

```
userLabel="LUN_5"  
capacity=128gb  
owner=B;
```

```
create volume drives[ 2,1 2,2 2,3 2,4 ]  
RAIDLevel=1  
segmentSize=512  
userLabel="LUN_6"  
capacity=128gb  
owner=B;
```

```
create volume drives[ 2,5 2,6 2,7 2,8 ]  
RAIDLevel=1  
segmentSize=512  
userLabel="LUN_7"  
capacity=128gb  
owner=B;
```

```
set volume["LUN_0"] LogicalUnitNumber=0 host="bmex346f";  
set volume["LUN_1"] LogicalUnitNumber=1 host="bmex346f";  
set volume["LUN_2"] LogicalUnitNumber=2 host="bmex346f";  
set volume["LUN_3"] LogicalUnitNumber=3 host="bmex346f";  
set volume["LUN_4"] LogicalUnitNumber=4 host="bmex346f";  
set volume["LUN_5"] LogicalUnitNumber=5 host="bmex346f";  
set volume["LUN_6"] LogicalUnitNumber=6 host="bmex346f";  
set volume["LUN_7"] LogicalUnitNumber=7 host="bmex346f";
```

```
set storageArray cacheFlushStop=80 cacheFlushStart=80 cacheBlockSize=16;
```

```
/* Setup for RDAC failover environment */
```

```
set controller[a] HostNVS RAMByte[0x00, 0x24]=0x00;  
set controller[a] HostNVS RAMByte[0x01, 0x24]=0x00;  
set controller[a] HostNVS RAMByte[0x02, 0x24]=0x00;  
set controller[a] HostNVS RAMByte[0x03, 0x24]=0x00;  
set controller[a] HostNVS RAMByte[0x04, 0x24]=0x00;  
set controller[a] HostNVS RAMByte[0x05, 0x24]=0x00;  
set controller[a] HostNVS RAMByte[0x06, 0x24]=0x00;  
set controller[a] HostNVS RAMByte[0x07, 0x24]=0x00;  
set controller[a] HostNVS RAMByte[0x08, 0x24]=0x00;  
set controller[a] HostNVS RAMByte[0x09, 0x24]=0x00;  
set controller[a] HostNVS RAMByte[0x0a, 0x24]=0x00;  
set controller[a] HostNVS RAMByte[0x0b, 0x24]=0x00;  
set controller[a] HostNVS RAMByte[0x0c, 0x24]=0x00;  
set controller[a] HostNVS RAMByte[0x0d, 0x24]=0x00;  
set controller[a] HostNVS RAMByte[0x0e, 0x24]=0x00;  
set controller[a] HostNVS RAMByte[0x0f, 0x24]=0x00;
```

```
set controller[b] HostNVS RAMByte[0x00, 0x24]=0x00;  
set controller[b] HostNVS RAMByte[0x01, 0x24]=0x00;
```



```
set controller[b] HostNVS RAMByte[0x02, 0x24]=0x00;
set controller[b] HostNVS RAMByte[0x03, 0x24]=0x00;
set controller[b] HostNVS RAMByte[0x04, 0x24]=0x00;
set controller[b] HostNVS RAMByte[0x05, 0x24]=0x00;
set controller[b] HostNVS RAMByte[0x06, 0x24]=0x00;
set controller[b] HostNVS RAMByte[0x07, 0x24]=0x00;
set controller[b] HostNVS RAMByte[0x08, 0x24]=0x00;
set controller[b] HostNVS RAMByte[0x09, 0x24]=0x00;
set controller[b] HostNVS RAMByte[0x0a, 0x24]=0x00;
set controller[b] HostNVS RAMByte[0x0b, 0x24]=0x00;
set controller[b] HostNVS RAMByte[0x0c, 0x24]=0x00;
set controller[b] HostNVS RAMByte[0x0d, 0x24]=0x00;
set controller[b] HostNVS RAMByte[0x0e, 0x24]=0x00;
set controller[b] HostNVS RAMByte[0x0f, 0x24]=0x00;
```

doSPC.bat

```
@echo *****
@echo * Warning make sure your boot device is PhysicalDrive 0 *
@echo *
@echo * diskpar is now a part of this script
@echo *****
timeout /t 60

@rem diskpar.bat
c:\bench\diskpar.exe -s 1 < diskpar.txt
c:\bench\diskpar.exe -s 2 < diskpar.txt
c:\bench\diskpar.exe -s 3 < diskpar.txt
c:\bench\diskpar.exe -s 4 < diskpar.txt
c:\bench\diskpar.exe -s 5 < diskpar.txt
c:\bench\diskpar.exe -s 6 < diskpar.txt
c:\bench\diskpar.exe -s 7 < diskpar.txt
c:\bench\diskpar.exe -s 8 < diskpar.txt

timeout /t 15 /NOBREAK
diskpart /s convertDynamic.script
timeout /t 15 /NOBREAK
diskpart /s createVolumes.script
```

diskpart.txt

```
y
y
65536
131037
```

convertDynamic.script

```
select disk 1
convert dynamic noerr
select disk 2
convert dynamic noerr
select disk 3
```

```
convert dynamic noerr
select disk 4
convert dynamic noerr
select disk 5
convert dynamic noerr
select disk 6
convert dynamic noerr
select disk 7
convert dynamic noerr
select disk 8
convert dynamic noerr
```

createVolumes.script

```
create volume stripe disk=1,2,3,4,5,6,7,8

list volume

select volume 0
delete volume noerr
select volume 1
delete volume noerr
select volume 2
delete volume noerr
select volume 3
delete volume noerr
select volume 4
delete volume noerr
select volume 5
delete volume noerr
select volume 6
delete volume noerr
select volume 7
delete volume noerr

create volume stripe size=11696 disk=1,2,3,4,5,6,7,8
assign letter=N
create volume stripe size=52632 disk=1,2,3,4,5,6,7,8
assign letter=L
create volume stripe size=52632 disk=1,2,3,4,5,6,7,8
assign letter=M
```

APPENDIX D: SPC-1 WORKLOAD GENERATOR STORAGE COMMANDS AND PARAMETERS

The content of SPC-1 Workload Generator command and parameter file, used in this benchmark, is listed below.

```
* spc1_metrics.cfg

javaparms="-Xmx640m -Xms640m"

sd=asu1_1,lun=\\.L:,size=441509216256
sd=asu2_1,lun=\\.M:,size=441509216256
sd=asu3_1,lun=\\.N:,size=98113159168

eof
```

APPENDIX E: SPC-1 WORKLOAD GENERATOR INPUT PARAMETERS

Primary Metrics Test, Repeatability Test, and Persistence Test Run 1

The following script was used to execute the Primary Metrics Test (*Sustainability Test Phase, IOPS Test Phase, and Response Time Ramp Test Phase*), Repeatability Test (*Repeatability Test Phase 1 and Repeatability Test Phase 2*), and Persistence Test Run 1 in an uninterrupted sequence.

```
java -Xmx640m -Xms640m metrics -b 180 -s 300
```

```
java -Xmx640m -Xms640m repeat1 -b 180 -s 300
```

```
java -Xmx640m -Xms640m repeat2 -b 180 -s 300
```

```
java -Xmx640m -Xms640m persist1 -b 180
```

Persistence Test Run 2

The following script was used to execute Persistence Test Run 2.

```
java -Xmx640m -Xms640m persist2
```