



SPC BENCHMARK 1™
FULL DISCLOSURE REPORT

NETWORK APPLIANCE, INC. (*TEST SPONSOR*)
EMC CLARION CX3 MODEL 40

SPC-1 V1.10.1

Submitted for Review: January 29, 2008

Submission Identifier: A00059

Revised: January 31, 2008

First Edition – January 2008

THE INFORMATION CONTAINED IN THIS DOCUMENT IS DISTRIBUTED ON AN AS IS BASIS WITHOUT ANY WARRANTY EITHER EXPRESS OR IMPLIED. The use of this information or the implementation of any of these techniques is the customer's responsibility and depends on the customer's ability to evaluate and integrate them into the customer's operational environment. While each item has been reviewed by Network Appliance, Inc. for accuracy in a specific situation, there is no guarantee that the same or similar results will be obtained elsewhere. Customers attempting to adapt these techniques to their own environment do so at their own risk.

This publication was produced in the United States. Network Appliance, Inc. does not offer all of the products, services, or features discussed in this document and the information is subject to change with notice. Consult your local Network Appliance, Inc. representative for information on products and services available in your area.

© Copyright Network Appliance, Inc. 2008. All rights reserved.

Permission is hereby granted to reproduce this document in whole or in part, provided the copyright notice as printed above is set forth in full text on the title page of each item reproduced.

Trademarks

SPC Benchmark-1, SPC-1, SPC-1 IOPS, and SPC-1 LRT are trademarks of the Storage Performance Council. NetApp is registered trademarks of Network Appliance, Inc. in the United States and other countries. All other brands, trademarks, and product names are the property of their respective owners.

Table of Contents

Audit Certification	vii
Audit Certification (cont.)	viii
Letter of Good Faith	ix
Executive Summary	10
Test Sponsor and Contact Information	10
Revision Information and Key Dates	10
Tested Storage Product (TSP) Description	10
Summary of Results	11
Storage Capacities and Relationships	11
Response Time - Throughput Curve	12
Response Time - Throughput Data	12
Tested Storage Configuration Pricing (Priced Storage Configuration)	13
Differences between the Tested Storage Configuration (TSC) and Priced Storage Configuration	13
Benchmark Configuration/Tested Storage Configuration Diagram	14
Benchmark Configuration/Tested Storage Configuration Components	15
Configuration Information	16
Benchmark Configuration (BC)/Tested Storage Configuration (TSC) Diagram	16
Storage Network Configuration	16
Host System Configuration	16
Customer Tunable Parameters and Options	17
Tested Storage Configuration (TSC) Description	17
SPC-1 Workload Generator Storage Configuration	17
SPC-1 Data Repository	18
Storage Capacities and Relationships	18
SPC-1 Storage Capacities	18
SPC-1 Storage Hierarchy Ratios	18
SPC-1 Storage Capacities and Relationships Illustration	19
Logical Volume Capacity and ASU Mapping	19
SPC-1 Benchmark Execution Results	20
SPC-1 Tests, Test Phases, and Test Runs	20
Primary Metrics Test - Sustainability Test Phase	21
SPC-1 Workload Generator Input Parameters	21
Sustainability Test Results File	21
Sustainability - Data Rate Distribution Data (MB/second).....	22

Sustainability – Data Rate Distribution Graph	23
Sustainability – I/O Request Throughput Distribution Data	24
Sustainability – I/O Request Throughput Distribution Graph	25
Sustainability – Average Response Time (ms) Distribution Data	26
Sustainability – Average Response Time (ms) Distribution Graph	27
Sustainability – Response Time Frequency Distribution Data	28
Sustainability – Response Time Frequency Distribution Graph	28
Sustainability – Measured Intensity Multiplier and Coefficient of Variation.....	29
Primary Metrics Test – IOPS Test Phase	30
SPC-1 Workload Generator Input Parameters	30
IOPS Test Results File.....	30
IOPS Test Run – I/O Request Throughput Distribution Data	31
IOPS Test Run – I/O Request Throughput Distribution Graph.....	31
IOPS Test Run – Average Response Time (ms) Distribution Data	32
IOPS Test Run – Average Response Time (ms) Distribution Graph	32
IOPS Test Run – Response Time Frequency Distribution Data	33
IOPS Test Run –Response Time Frequency Distribution Graph.....	33
IOPS Test Run – I/O Request Information.....	34
IOPS Test Run – Measured Intensity Multiplier and Coefficient of Variation.....	34
Primary Metrics Test – Response Time Ramp Test Phase	35
SPC-1 Workload Generator Input Parameters	35
Response Time Ramp Test Results File.....	35
Response Time Ramp Distribution (IOPS) Data.....	36
Response Time Ramp Distribution (IOPS) Graph	37
SPC-1 LRT™ Average Response Time (ms) Distribution Data.....	38
SPC-1 LRT™ Average Response Time (ms) Distribution Graph	38
SPC-1 LRT™ (10%) – Measured Intensity Multiplier and Coefficient of Variation	39
Repeatability Test	40
SPC-1 Workload Generator Input Parameters	40
Repeatability Test Results File	41
Repeatability 1 LRT – I/O Request Throughput Distribution Data.....	42
Repeatability 1 LRT – I/O Request Throughput Distribution Graph	42
Repeatability 1 LRT –Average Response Time (ms) Distribution Data	43
Repeatability 1 LRT –Average Response Time (ms) Distribution Graph.....	43
Repeatability 1 IOPS – I/O Request Throughput Distribution Data	44
Repeatability 1 IOPS – I/O Request Throughput Distribution Graph.....	44
Repeatability 1 IOPS –Average Response Time (ms) Distribution Data.....	45
Repeatability 1 IOPS –Average Response Time (ms) Distribution Graph	45
Repeatability 2 LRT – I/O Request Throughput Distribution Data.....	46

Repeatability 2 LRT – I/O Request Throughput Distribution Graph	46
Repeatability 2 LRT –Average Response Time (ms) Distribution Data	47
Repeatability 2 LRT –Average Response Time (ms) Distribution Graph.....	47
Repeatability 2 IOPS – I/O Request Throughput Distribution Data	48
Repeatability 2 IOPS – I/O Request Throughput Distribution Graph.....	48
Repeatability 2 IOPS –Average Response Time (ms) Distribution Data.....	49
Repeatability 2 IOPS –Average Response Time (ms) Distribution Graph	49
Repeatability 1 (LRT) Measured Intensity Multiplier and Coefficient of Variation	50
Repeatability 1 (IOPS) Measured Intensity Multiplier and Coefficient of Variation	50
Repeatability 2 (LRT) Measured Intensity Multiplier and Coefficient of Variation	50
Repeatability 2 (IOPS) Measured Intensity Multiplier and Coefficient of Variation	51
Data Persistence Test.....	52
SPC-1 Workload Generator Input Parameters	52
Data Persistence Test Results File	52
Data Persistence Test Results.....	53
Priced Storage Configuration Availability Date.....	54
Pricing Information.....	54
Anomalies or Irregularities	54
Appendix A: SPC-1 Glossary	55
“Decimal” (<i>powers of ten</i>) Measurement Units.....	55
“Binary” (<i>powers of two</i>) Measurement Units.....	55
SPC-1 Data Repository Definitions.....	55
SPC-1 Data Protection Levels	56
SPC-1 Test Execution Definitions	56
I/O Completion Types	58
SPC-1 Test Run Components	58
Appendix B: Customer Tunable Parameters and Options.....	59
Windows 2003 Server.....	59
CX3-40 Storage System.....	59
Appendix C: Tested Storage Configuration (TSC) Creation	60
Storage System.....	60
Create RAID Groups.....	60
Create LUNs.....	60
Change LUN Parameters	62
Host System	64
Brocade FCP Switches.....	65

Appendix D: SPC-1 Workload Generator Storage Commands and Parameters	66
Appendix E: SPC-1 Workload Generator Input Parameters	67
Primary Metrics Test, Repeatability Test, and Persistence Test Run 1	67
Persistence Test Run 2.....	67
Appendix F: Third-Party Quote	68

AUDIT CERTIFICATION



Steve Daniel
Network Appliance, Inc.
7301 Kit Creek Road, Building 1
Research Triangle Park, NC 27709

January 29, 2008

The SPC Benchmark 1™ results listed below for the EMC CLARiiON CX3 Model 40 were produced in compliance with the SPC Benchmark 1™ V1.10.1 Onsite Audit requirements.

SPC Benchmark 1™ V1.10.1 Results	
Tested Storage Configuration (TSC) Name:	
EMC CLARiiON CX3 Model 40	
Metric	Reported Result
SPC-1 IOPS™	24,997.49
SPC-1 Price-Performance	\$20.72/SPC-1 IOPS™
Total ASU Capacity	8,465.016 GB
Data Protection Level	Mirroring
Total TSC Price (including three-year maintenance)	\$517,851

The following SPC Benchmark 1™ Onsite Audit requirements were reviewed and found compliant with V1.10.1 of the SPC Benchmark 1™ specification:

- A Letter of Good Faith, signed by a senior executive.
- The following Data Repository storage items were verified by physical inspection and information supplied by Network Appliance, Inc.:
 - ✓ Physical Storage Capacity and requirements.
 - ✓ Configured Storage Capacity and requirements.
 - ✓ Addressable Storage Capacity and requirements.
 - ✓ Capacity of each Logical Volume and requirements.
 - ✓ Capacity of each Application Storage Unit (ASU) and requirements.
- An appropriate diagram of the Benchmark Configuration (BC)/Tested Storage Configuration (TSC).
- Physical verification of the components to match the above diagram.

Storage Performance Council
643 Bair Island Road, Suite 103
Redwood City, CA 94062
AuditService@storageperformance.org
650.556.9384

AUDIT CERTIFICATION (CONT.)

EMC CLARiiON CX3 Model 40
SPC-1 Audit Certification

Page 2

- Listings and commands to configure the Benchmark Configuration/Tested Storage Configuration, including customer tunable parameters.
- Commands and parameters used to configure the SPC-1 Workload Generator.
- The following Host System requirements were verified by physical inspection and information supplied by Network Appliance, Inc.:
 - ✓ The type of Host System including the number of processors and main memory.
 - ✓ The presence and version number of the Workload Generator on the Host System.
 - ✓ The TSC boundary within the Host System.
- The execution of each Test, Test Phase, and Test Run was observed and found compliant with all of the requirements and constraints of Clauses 4 and 5 of the SPC-1 Benchmark Specification.
- The Test Results Files and resultant Summary Results Files received from Network Appliance, Inc. for each of following were authentic, accurate, and compliant with all of the requirements and constraints of Clauses 4 and 5 of the SPC-1 Benchmark Specification:
 - ✓ Data Persistence Test
 - ✓ Sustainability Test Phase
 - ✓ IOPS Test Phase
 - ✓ Response Time Ramp Test Phase
 - ✓ Repeatability Test
- There were no differences between the Tested Storage Configuration (TSC) used for the benchmark and Priced Storage Configuration.
- The submitted pricing information met all of the requirements and constraints of Clause 8 of the SPC-1 Benchmark Specification.
- The Full Disclosure Report (FDR) met all of the requirements in Clause 9 of the SPC-1 Benchmark Specification.
- This successfully audited SPC measurement is not subject to an SPC Confidential Review.

Audit Notes:

There were no audit notes or exceptions.

Respectfully,

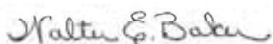

Walter E. Baker
SPC Auditor

Storage Performance Council
643 Bair Island Road, Suite 103
Redwood City, CA 94062
AuditService@storageperformance.org
650.556.9384

LETTER OF GOOD FAITH

7 January, 2008

Walter Baker
Gradient Systems
643 Blair Island Road, Suite 103
Redwood City, CA 94063-2755

To: Walter Baker
Subject: SPC-1 Letter of Good Faith for the EMC CLARiiON CX 3 Model 40

Network Appliance, Inc is the SPC-1 Test Sponsor for the above listed product. To the best of our knowledge and belief, the required SPC-1 benchmark results and materials we have submitted for that product are complete, accurate, and in full compliance with V1.10.1 of the SPC-1 benchmark specification.

In addition, we have reported any items in the Benchmark Configuration and execution of the benchmark that affected the reported results even if the items are not explicitly required to be disclosed by the SPC-1 benchmark specification.

Sincerely,

A handwritten signature in black ink, appearing to read 'Phil Brotherton'.

Phil Brotherton
Vice President
Enterprise Applications Business Unit

Network Appliance, Inc. 495 East Java Drive Sunnyvale, CA 94088 Telephone 408.822.6000 Fax 408.822.4501
www.netapp.com

EXECUTIVE SUMMARY

Test Sponsor and Contact Information

Test Sponsor and Contact Information	
Test Sponsor Primary Contact	Network Appliance, Inc. – http://www.netapp.com/ Steve Daniel – daniel@netapp.com 7301 Kit Creek Road Building 1 Research Triangle Park, NC 27709 Phone: (919) 476-5726 FAX: (919) 476-4272
Test Sponsor Alternate Contact	Network Appliance, Inc. – http://www.netapp.com/ Dean Brock – Dean.Brock@netapp.com 7301 Kit Creek Road Building 1 Research Triangle Park, NC 27709 Phone: (919) 476-5609 FAX: (919) 476-4272
Auditor	Storage Performance Council – http://www.storageperformance.org Walter E. Baker – AuditService@StoragePerformance.org 643 Bair Island Road, Suite 103 Redwood City, CA 94063 Phone: (650) 556-9384 FAX: (650) 556-9385

Revision Information and Key Dates

Revision Information and Key Dates	
SPC-1 Specification revision number	V1.10.1
SPC-1 Workload Generator revision number	V2.00.04a
Date Results were first used publicly	January 29, 2008
Date the FDR was submitted to the SPC	January 29, 2008
Date revised FDR was submitted to the SPC Inclusion of omitted capacities diagram: page 11 Activation of hyperlinks to results files: various pages	January 31, 2008
Date the TSC is available for shipment to customers	currently available
Date the TSC completed audit certification	January 29, 2008

Tested Storage Product (TSP) Description

The CX3-40 is the performance workhorse of EMC's CLARiiON CX3 UltraScale series. Featuring quad Xeon processors, 8 GB memory, quad 4 Gb/s back-end loops, and support for up to 240 drives, the CX3-40 appeals to commercial and enterprise customers with OLTP and messaging (e.g., Microsoft Exchange) workloads, and with larger requirements for array-based replication. Enterprise-class business continuance features include hot-pluggable redundant hardware, hot spare disk drives, multi-path failover, snapshots, cloning, local/remote mirroring, and non-disruptive firmware upgrades.

Summary of Results

SPC-1 Results	
Tested Storage Configuration (TSC) Name: EMC CLARiiON CX3 Model 40	
Metric	Reported Result
SPC-1 IOPS™	24,997.49
SPC-1 Price-Performance	\$20.72/SPC-1 IOPS™
Total ASU Capacity	8,465.016 GB
Data Protection Level	Mirroring
Total TSC Price (including three-year maintenance)	\$517,851

SPC-1 IOPS™ represents the maximum I/O Request Throughput at the 100% load point.

Total ASU (Application Storage Unit) Capacity represents the total storage capacity read and written in the course of executing the SPC-1 benchmark.

A **Data Protection Level** of Mirroring configures two or more identical copies of user data.

Storage Capacities and Relationships

The following diagram documents the various storage capacities, used in this benchmark, and their relationships.

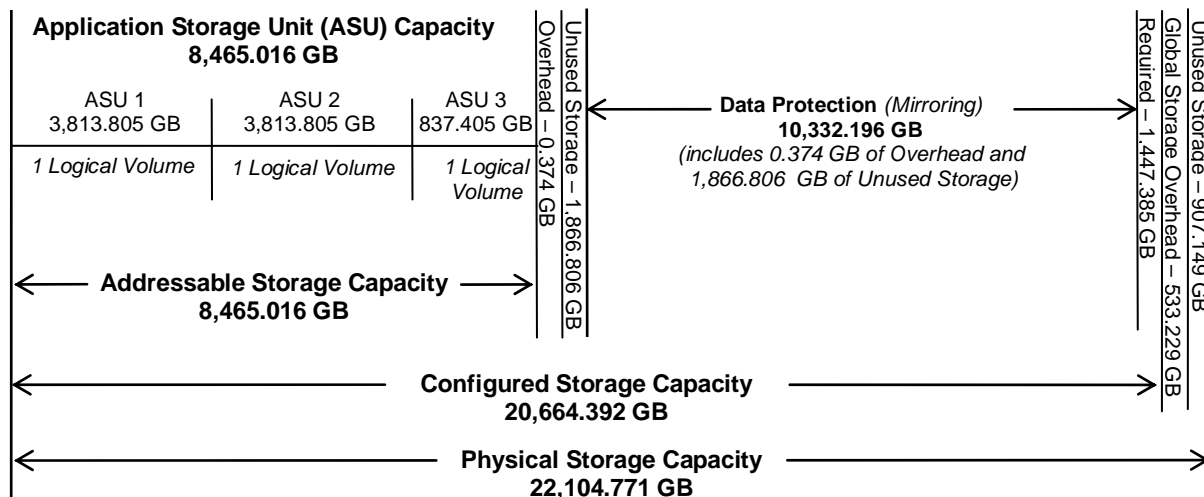

Response Time – Throughput Curve

The Response Time-Throughput Curve illustrates the Average Response Time (milliseconds) and I/O Request Throughput at 100%, 95%, 90%, 80%, 50%, and 10% of the workload level used to generate the SPC-1 IOPS™ metric.

The Average Response Time measured at any of the above load points cannot exceed 30 milliseconds or the benchmark measurement is invalid.

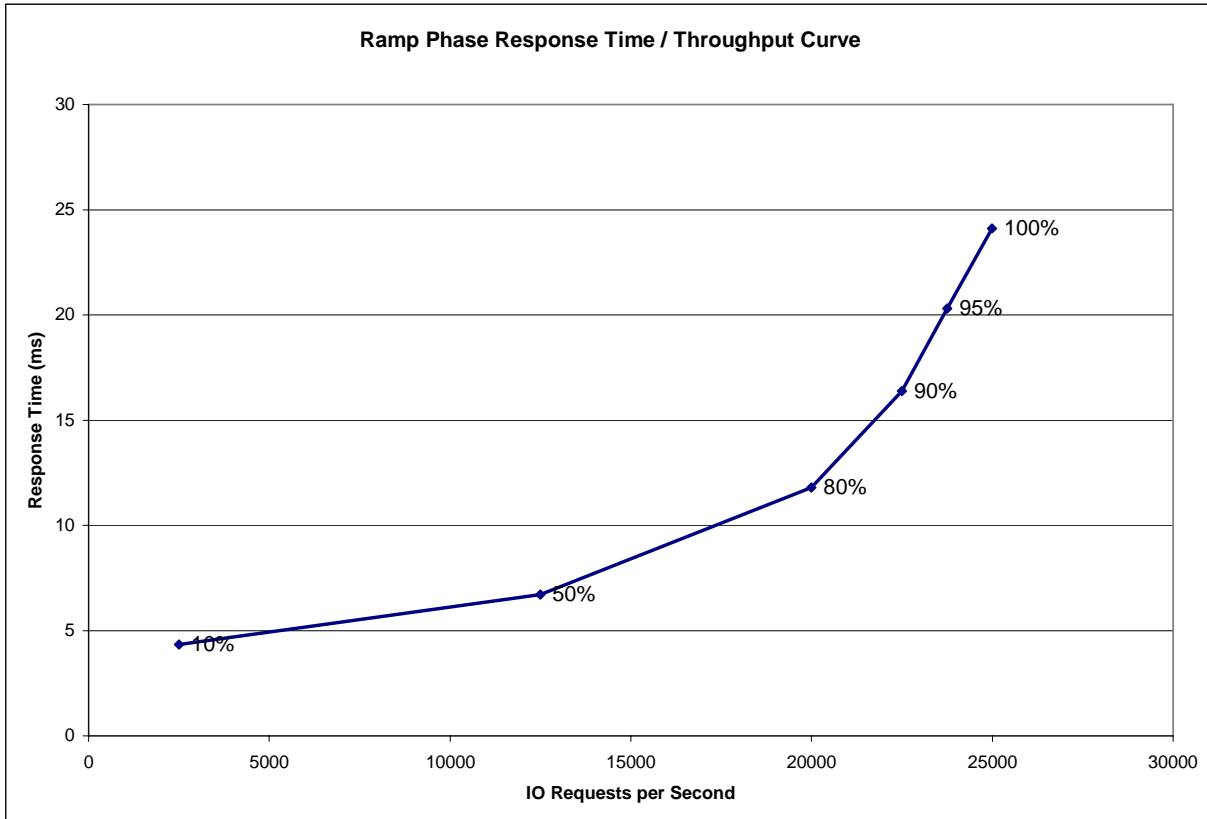

Response Time – Throughput Data

	10% Load	50% Load	80% Load	90% Load	95% Load	100% Load
I/O Request Throughput	2,498.36	12,498.52	20,001.97	22,497.69	23,757.01	24,997.49
Average Response Time (ms):						
All ASUs	4.34	6.72	11.79	16.37	20.31	24.12
ASU-1	5.71	8.68	14.72	20.22	25.21	30.06
ASU-2	5.69	9.14	17.46	23.59	28.43	32.41
ASU-3	0.83	1.50	3.12	5.04	6.37	7.88
Reads	4.23	6.34	10.87	15.25	19.32	23.35
Writes	4.41	6.96	12.39	17.10	20.95	24.61

Tested Storage Configuration Pricing (*Priced Storage Configuration*)

Qty	Product	U/M	Unit List	Discount	Total	Vendor
1	CX3-40C-FD - SPE-FIELD INSTALL	EA	\$42,300	0%	\$42,300	see attached third party quotation
11	CX-4PDAE-FD - 4G DAE FIELD INSTALL	EA	\$5,900	0%	\$64,900	see attached third party quotation
150	CX-4G15-146 - 146GB 15K 4GB FC	EA	\$1,645	0%	\$246,750	see attached third party quotation
1	V-CX4014615K - VAULT PACK CX3-40 146GB 15K 4GB DRIVES QTY 5	EA	\$8,225	0%	\$8,225	see attached third party quotation
4	FC2-HSSDC-8M - 8M HSSDC2 to HSSDC2 bus cbl	EA	\$600	0%	\$2,400	see attached third party quotation
1	PP-WN-KIT - POWERPATH WINDOWS KIT	EA	\$0	0%	\$0	see attached third party quotation
1	NAV-ENKIT - NAVI ENTERPRISE MEDIA	EA	\$0	0%	\$0	see attached third party quotation
8	NAVAGT-WINKIT - NAVI AGENT WINDOWS MEDIA	EA	\$0	0%	\$0	see attached third party quotation
8	UTIL-WIN - Windows Software Utilities	EA	\$40	0%	\$320	see attached third party quotation
1	CX34C-KIT - CS3-40C DOCS AND RTU KIT	EA	\$0	0%	\$0	see attached third party quotation
1	C-MODEM-US - CLARIION SERVICE MODEM-US	EA	\$0	0%	\$0	see attached third party quotation
1	NAV34-EN - NAVI MGR CX3-40 ENTPR LIC	EA	\$58,000	0%	\$58,000	see attached third party quotation
1	PP-WN-WG - PPATH WINDOWS WGR	EA	\$1,440	0%	\$1,440	see attached third party quotation
1	PS-BAS-PP1 - POWERPATH 1HOST QS	EA	\$1,330	0%	\$1,330	see attached third party quotation
1	PS-BAS-PMBLK - POWERPATH 1HOST QS	EA	\$1,970	0%	\$1,970	see attached third party quotation
1	M-PRESW-001- premium software support	EA	\$33,929	0%	\$33,929	see attached third party quotation
1	M-PRESW-004 - premium software support - open SW	EA	\$777	0%	\$777	see attached third party quotation
1	WU-PREHW-001- premium hardware support	EA	\$31,317	0%	\$31,317	see attached third party quotation
2	QLA2462-E-SP - 2 PORT 4GB PCI-X	EA	\$1,700	0%	\$3,400	see attached third party quotation
2	Brocade 16-Port 200e FC Full Fab Switch,-C,R5	EA	\$8,700	0%	\$17,400	Network Appliance, Inc.
2	BSWITCH-16PORT-R5 HW Support,Premium,4hr,y mths:36	EA	\$1,697	0%	\$3,393	Network Appliance, Inc.
2	BSWITCH-16PORT-R5 SW Subs,Premium,4hr,y mths:36	EA	\$0	0%	\$0	Network Appliance, Inc.
Hardware Total					\$385,375	
Software Total					\$59,760	
Services Total					\$3,300	
prepaid software maintenance (3YR-4HOUR)					\$34,706	
hardware warranty upgrade summary (3YR 4HOUR)					\$34,710	
Total Price					\$517,851	

Differences between the Tested Storage Configuration (TSC) and Priced Storage Configuration

The Tested Storage Configuration contained 154 disk drives and the Priced Storage Configuration contained 155 disk drives.

Benchmark Configuration/Tested Storage Configuration Diagram

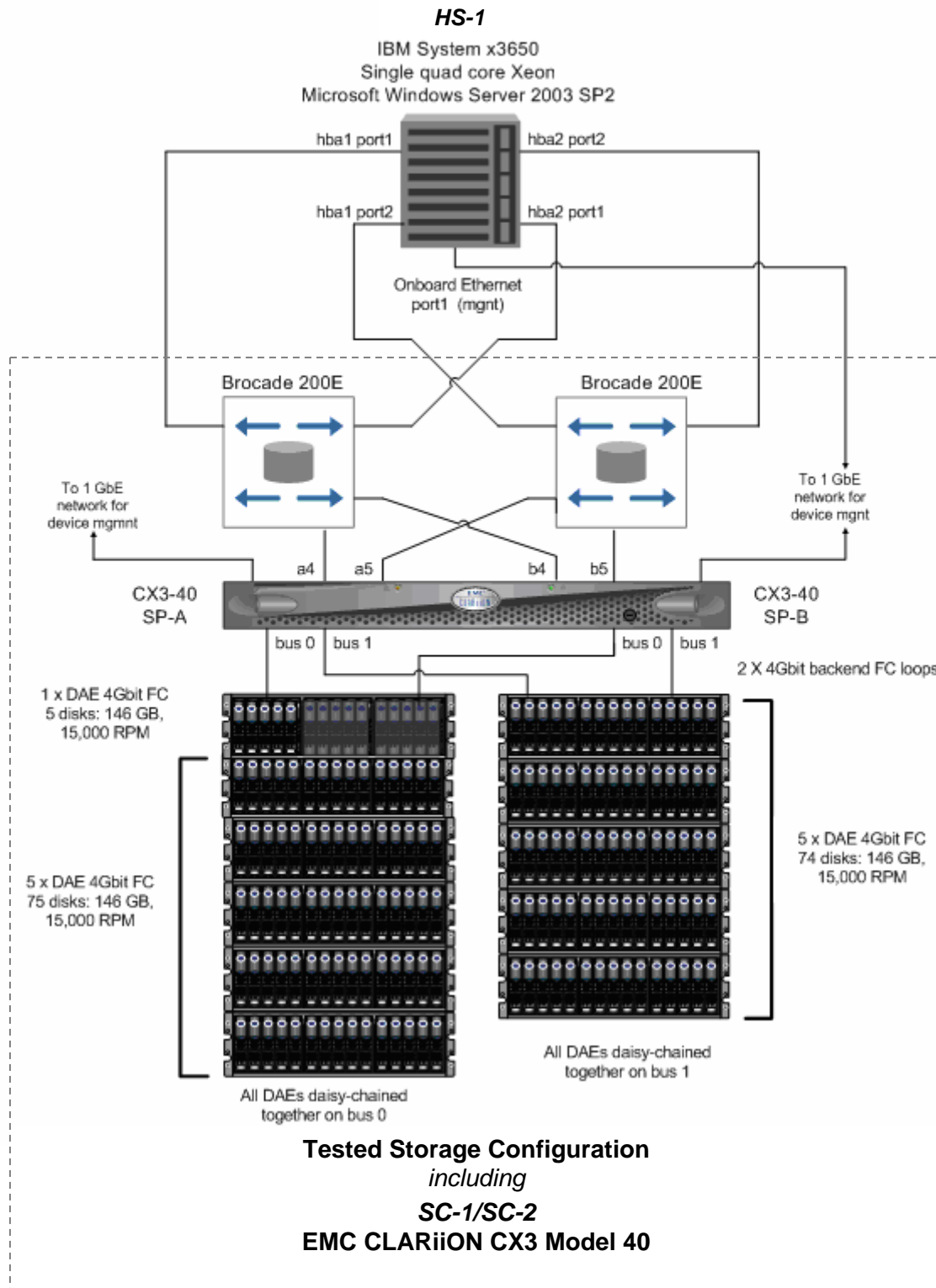

Benchmark Configuration/Tested Storage Configuration Components

Host System:	Tested Storage Configuration (TSC):
HS-1: IBM System x3650	2 – Qlogic QLA2462-E, 2-Port, 4Gb, PCI-X HBAs
Single quad core Xeon processor	2 – Brocade 16-Port 200e FC switches
3 GHz CPUs, 8 MB cache per CPU	SC-1/SC-2: EMC CLARiiON CX3 Model 40 2 – storage controllers each with: 2 – Intel Xeon 2.8 GHz processors FLARE 03.26.040.5.005 4 GB main memory and cache 2 – 4Gb/s front-end ports 2 – 4Gb/s backend ports
18 GB main memory	
Windows Server 2003 with SP2	
Priced Host System Software: Navisphere Powerpath Windows Kit 5.0	
PCI-X	
WG	154 – 146 GB 15K RPM disk drives

In each of the following sections of this document, the appropriate Full Disclosure Report requirement, from the SPC-1 benchmark specification, is stated in italics followed by the information to fulfill the stated requirement.

CONFIGURATION INFORMATION

Benchmark Configuration (BC)/Tested Storage Configuration (TSC) Diagram

Clause 9.2.4.4.1

A one page Benchmark Configuration (BC)/Tested Storage Configuration (TSC) diagram shall be included in the Executive Summary...

The Benchmark Configuration (BC)/Tested Storage Configuration (TSC) is illustrated on page 14 (*Benchmark Configuration/Tested Storage Configuration Diagram*).

Storage Network Configuration

Clause 9.2.4.4.1

...

5. *If the TSC contains network storage, the diagram will include the network configuration. If a single diagram is not sufficient to illustrate both the Benchmark Configuration and network configuration in sufficient detail, the Benchmark Configuration diagram will include a high-level network illustration as shown in Figure 9-8. In that case, a separate, detailed network configuration diagram will also be included as described in Clause 9.2.4.4.2.*

Clause 9.2.4.4.2

If a storage network was configured as a part of the Tested Storage Configuration and the Benchmark Configuration diagram described in Clause 9.2.4.4.1 contains a high-level illustration of the network configuration, the Executive Summary will contain a one page topology diagram of the storage network as illustrated in Figure 9-9.

The Benchmark Configuration (BC)/Tested Storage Configuration (TSC), including the network configuration, is illustrated on page 14 (*Benchmark Configuration/Tested Storage Configuration Diagram*).

Host System Configuration

Clause 9.2.4.4.3

The FDR shall minimally contain, for each Host System running the Workload Generator, a listing of the following:

1. *Number and type of CPUs.*
2. *Main memory capacity.*
3. *Cache memory capacity.*
4. *Number and type of disk controllers or Host Bus Adapters.*

The details of the Host System configuration may be found on page 14 (*Benchmark Configuration/Tested Storage Configuration Diagram*).

Customer Tunable Parameters and Options

Clause 9.2.4.5.1

All Benchmark Configuration (BC) components with customer tunable parameter and options that have been altered from their default values must be listed in the FDR. The FDR entry for each of those components must include both the name of the component and the altered value of the parameter or option. If the parameter name is not self-explanatory to a knowledgeable practitioner, a brief description of the parameter's use must also be included in the FDR entry.

“Appendix B: Customer Tunable Parameters and Options” on page 59 contains the customer tunable parameters and options that have been altered from their default values for this benchmark.

Tested Storage Configuration (TSC) Description

Clause 9.2.4.5.2

The FDR must include sufficient information to recreate the logical representation of the TSC. In addition to customer tunable parameters and options (Clause 4.2.4.5.3), that information must include, at a minimum:

- A diagram and/or description of the following:
 - All physical components that comprise the TSC. Those components are also illustrated in the BC Configuration Diagram in Clause 9.2.4.4.1 and/or the Storage Network Configuration Diagram in Clause 9.2.4.4.2.
 - The logical representation of the TSC, configured from the above components that will be presented to the Workload Generator.
- Listings of scripts used to create the logical representation of the TSC.
- If scripts were not used, a description of the process used with sufficient detail to recreate the logical representation of the TSC.

“Appendix C: Tested Storage Configuration (TSC) Creation” on page 60 contains the detailed information that describes how to create and configure the logical TSC.

SPC-1 Workload Generator Storage Configuration

Clause 9.2.4.5.3

The FDR must include all SPC-1 Workload Generator storage configuration commands and parameters.

The SPC-1 Workload Generator storage configuration commands and parameters for this measurement appear in “Appendix D: SPC-1 Workload Generator Storage Commands and Parameters” on page 66.

SPC-1 DATA REPOSITORY

This portion of the Full Disclosure Report presents the detailed information that fully documents the various SPC-1 storage capacities and mappings used in the Tested Storage Configuration. “SPC-1 Data Repository Definitions” on page 55 contains definitions of terms specific to the SPC-1 Data Repository.

Storage Capacities and Relationships

Clause 9.2.4.6.1

Two tables and an illustration documenting the storage capacities and relationships of the SPC-1 Storage Hierarchy (Clause 2.1) shall be included in the FDR.

SPC-1 Storage Capacities

SPC-1 Storage Capacities		
Storage Hierarchy Component	Units	Capacity
Total ASU Capacity	Gigabytes (GB)	8,465.016
Addressable Storage Capacity	Gigabytes (GB)	8,465.016
Configured Storage Capacity	Gigabytes (GB)	20,664.392
Physical Storage Capacity	Gigabytes (GB)	22,104.771
Data Protection (<i>Mirroring</i>)	Gigabytes (GB)	10,332.196
Required Storage (<i>spares/firmware drives</i>)	Gigabytes (GB)	1,447.385
Global Storage Overhead	Gigabytes (GB)	533.229
Total Unused Storage	Gigabytes (GB)	4,640.761

SPC-1 Storage Hierarchy Ratios

	Addressable Storage Capacity	Configured Storage Capacity	Physical Storage Capacity
Total ASU Capacity	100.00%	40.96%	38.29%
Required for Data Protection (Mirroring)		50.00%	46.74%
Addressable Storage Capacity		40.96%	38.29%
Required Storage		7.00%	6.55%
Configured Storage Capacity			93.48%
Global Storage Overhead			2.41%
Unused Storage:			
Addressable	0.00%		
Configured		18.07%	
Physical			4.10%

The Physical Storage Capacity consisted of 22,104.771 GB distributed over 154 disk drives each with a formatted capacity of 144.738 GB of which 143.537 GB was available. There was 907.149 GB (4.10%) of Unused Storage within the Physical Storage Capacity. Global Storage Overhead consisted of 533.229 GB (2.41%) of Physical Storage Capacity. There was 3,733.612 GB (18.07%) of Unused Storage within the Configured Storage Capacity. The Total ASU Capacity utilized 100.00% of the Addressable Storage Capacity resulting in 0.000 GB (0.00%) of Unused Storage within the Addressable Storage Capacity.

SPC-1 Storage Capacities and Relationships Illustration

The various storage capacities configured in the benchmark result are illustrated below (not to scale).

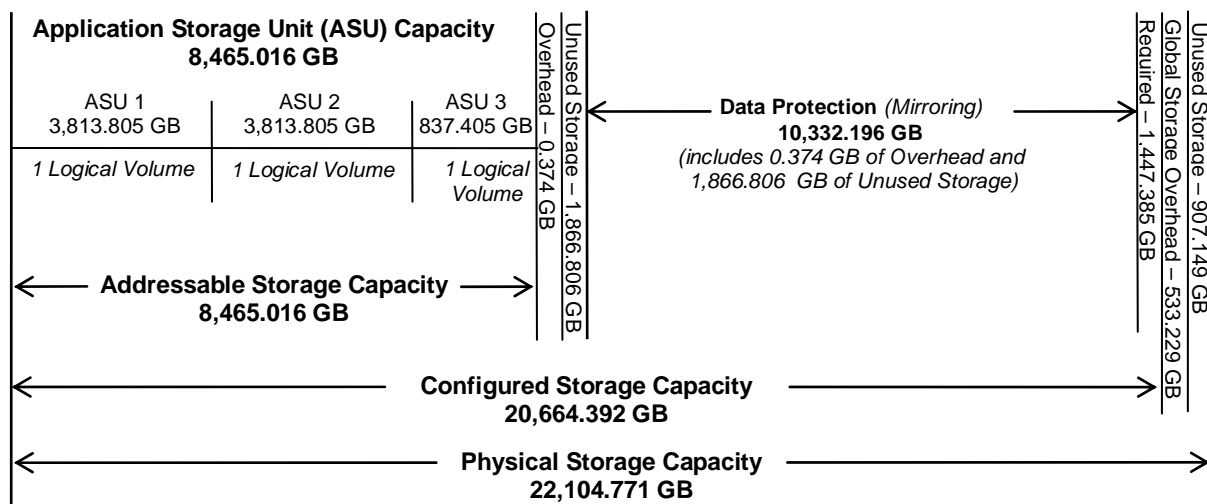

Logical Volume Capacity and ASU Mapping

Clause 9.2.4.6.2

A table illustrating the capacity of each ASU and the mapping of Logical Volumes to ASUs shall be provided in the FDR. ... Logical Volumes shall be sequenced in the table from top to bottom per its position in the contiguous address space of each ASU. The capacity of each Logical Volume shall be stated. ... In conjunction with this table, the Test Sponsor shall provide a complete description of the type of data protection (see Clause 2.4.5) used on each Logical Volume.

Logical Volume Capacity and Mapping		
ASU-1 (3,813.805 GB)	ASU-2 (3,813.805 GB)	ASU-3 (837.405 GB)
1 Logical Volume 3,813.805 GB per Logical Volume (3,813.805 GB used per Logical Volume)	1 Logical Volume 3,813.805 GB per Logical Volume (3,813.805 GB used per Logical Volume)	1 Logical Volume 836.405 GB per Logical Volume (836.405 GB used per Logical Volume)

The Data Protection Level used for all Logical Volumes was Mirroring as described on page 11. See “ASU Configuration” in the [IOPS Test Results](#) File for more detailed configuration information.

SPC-1 BENCHMARK EXECUTION RESULTS

This portion of the Full Disclosure Report documents the results of the various SPC-1 Tests, Test Phases, and Test Runs. “SPC-1 Test Execution Definitions” on page 56 contains definitions of terms specific to the SPC-1 Tests, Test Phases, and Test Runs.

Clause 5.4.3

The Tests must be executed in the following sequence: Primary Metrics, Repeatability, and Data Persistence. That required sequence must be uninterrupted from the start of Primary Metrics to the completion of Persistence Test Run 1. Uninterrupted means the Benchmark Configuration shall not be power cycled, restarted, disturbed, altered, or adjusted during the above measurement sequence. If the required sequence is interrupted other than for the Host System/TSC power cycle between the two Persistence Test Runs, the measurement is invalid.

SPC-1 Tests, Test Phases, and Test Runs

The SPC-1 benchmark consists of the following Tests, Test Phases, and Test Runs:

- **Primary Metrics Test**
 - Sustainability Test Phase and Test Run
 - IOPS Test Phase and Test Run
 - Response Time Ramp Test Phase
 - 95% of IOPS Test Run
 - 90% of IOPS Test Run
 - 80% of IOPS Test Run
 - 50% of IOPS Test Run
 - 10% of IOPS Test Run (LRT)
- **Repeatability Test**
 - Repeatability Test Phase 1
 - 10% of IOPS Test Run (LRT)
 - IOPS Test Run
 - Repeatability Test Phase 2
 - 10% of IOPS Test Run (LRT)
 - IOPS Test Run
- **Data Persistence Test**
 - Data Persistence Test Run 1
 - Data Persistence Test Run 2

Each Test is an atomic unit that must be executed from start to finish before any other Test, Test Phase, or Test Run may be executed.

The results from each Test, Test Phase, and Test Run are listed below along with a more detailed explanation of each component.

Primary Metrics Test – Sustainability Test Phase

Clause 5.4.4.1.1

The Sustainability Test Phase has exactly one Test Run and shall demonstrate the maximum sustainable I/O Request Throughput within at least a continuous three (3) hour Measurement Interval. This Test Phase also serves to insure that the TSC has reached Steady State prior to reporting the final maximum I/O Request Throughput result (SPC-1 IOPS™).

Clause 5.4.4.1.2

The computed I/O Request Throughput of the Sustainability Test must be within 5% of the reported SPC-1 IOPS™ result.

Clause 5.4.4.1.4

The Average Response Time, as defined in Clause 5.1.1, will be computed and reported for the Sustainability Test Run and cannot exceed 30 milliseconds. If the Average Response time exceeds that 30-milliseconds constraint, the measurement is invalid.

Clause 9.2.4.7.1

For the Sustainability Test Phase the FDR shall contain:

- 1. A Data Rate Distribution graph and data table.*
- 2. I/O Request Throughput Distribution graph and data table.*
- 3. A Response Time Frequency Distribution graph and table.*
- 4. An Average Response Time Distribution graph and table.*
- 5. The human readable Test Run Results File produced by the Workload Generator (may be included in an appendix).*
- 6. A listing or screen image of all input parameters supplied to the Workload Generator (may be included in an appendix).*
- 7. The Measured Intensity Multiplier for each I/O stream.*
- 8. The variability of the Measured Intensity Multiplier, as defined in Clause 5.3.13.3.*

SPC-1 Workload Generator Input Parameters

The SPC-1 Workload Generator input parameters for the Sustainability, IOPS, Response Time Ramp, Repeatability, and Persistence Test Runs are documented in “Appendix E: SPC-1 Workload Generator Input Parameters” on Page 67.

Sustainability Test Results File

A link to the test results file generated from the Sustainability Test Run is listed below.

[Sustainability Test Results File](#)

Sustainability – Data Rate Distribution Data (MB/second)

Ramp-Up/Start-Up Measurement Interval		Start	Stop	Interval	Duration															
		19:51:08	19:54:08	0-2	0:03:00															
		19:54:08	22:54:08	3-182	3:00:00															
Interval	All ASUs	ASU1	ASU2	ASU3	Interval	All ASUs	ASU1	ASU2	ASU3	Interval	All ASUs	ASU1	ASU2	ASU3						
0	205.54	79.88	22.00	103.65	63	205.12	79.63	21.77	103.72	126	204.55	79.74	21.82	102.98						
1	205.08	79.84	21.86	103.38	64	205.20	79.34	21.97	103.90	127	205.05	79.62	21.84	103.58						
2	205.29	79.78	21.93	103.58	65	205.32	79.67	21.95	103.70	128	205.18	79.51	22.06	103.61						
3	205.20	79.84	21.85	103.50	66	205.17	79.66	21.91	103.61	129	205.23	79.76	21.95	103.51						
4	205.20	79.70	21.85	103.65	67	204.98	79.76	21.97	103.26	130	204.99	79.53	21.91	103.55						
5	205.38	79.90	21.90	103.58	68	204.97	79.43	21.86	103.68	131	205.24	79.64	21.83	103.77						
6	205.12	79.63	21.81	103.68	69	205.44	79.52	22.08	103.83	132	204.95	79.86	21.99	103.10						
7	204.94	79.73	21.94	103.26	70	205.72	79.78	22.07	103.87	133	205.02	79.79	21.68	103.55						
8	204.99	79.63	22.00	103.36	71	204.82	79.59	21.98	103.24	134	204.79	79.60	21.83	103.36						
9	204.74	79.61	21.83	103.30	72	202.42	78.45	21.60	102.38	135	205.17	79.91	21.86	103.40						
10	205.16	79.82	21.90	103.44	73	207.77	80.82	22.08	104.87	136	204.97	79.64	21.88	103.44						
11	205.02	79.46	21.85	103.71	74	205.44	79.65	21.89	103.90	137	205.29	79.73	22.03	103.53						
12	205.41	79.44	22.04	103.93	75	204.43	79.55	21.87	103.01	138	205.31	79.75	22.05	103.51						
13	204.98	79.61	21.97	103.41	76	205.49	79.87	21.85	103.77	139	204.88	79.68	21.87	103.33						
14	204.94	79.54	21.79	103.61	77	205.13	79.68	21.93	103.52	140	205.13	79.92	21.97	103.24						
15	204.85	79.66	21.94	103.24	78	204.86	79.59	21.72	103.55	141	205.80	79.60	21.91	104.29						
16	204.74	79.70	21.79	103.25	79	205.39	79.76	22.05	103.57	142	205.10	79.56	21.85	103.69						
17	205.31	79.84	21.96	103.51	80	204.90	79.31	22.06	103.54	143	205.09	79.36	21.79	103.94						
18	205.11	79.74	21.97	103.40	81	205.27	79.80	21.87	103.60	144	205.29	79.77	21.96	103.56						
19	205.47	79.68	21.94	103.85	82	205.33	79.64	22.11	103.58	145	205.37	79.45	22.04	103.88						
20	205.53	79.73	21.88	103.92	83	205.30	79.75	22.01	103.54	146	204.91	79.59	21.75	103.57						
21	205.32	79.70	21.93	103.69	84	204.83	79.56	21.83	103.44	147	205.18	79.81	22.03	103.35						
22	204.92	79.73	21.75	103.43	85	204.48	79.47	21.84	103.18	148	205.04	79.85	21.86	103.33						
23	205.09	79.64	21.91	103.54	86	205.60	79.74	21.96	103.89	149	204.89	79.47	21.94	103.48						
24	204.87	79.73	21.93	103.21	87	205.41	79.69	21.94	103.78	150	205.24	79.64	21.87	103.74						
25	205.18	79.47	22.04	103.68	88	205.13	79.71	21.84	103.58	151	204.45	79.51	21.77	103.17						
26	205.06	79.77	21.99	103.31	89	205.15	79.82	21.90	103.43	152	205.41	79.70	22.04	103.67						
27	204.70	79.24	21.96	103.49	90	205.13	79.46	21.84	103.83	153	205.22	79.64	21.85	103.73						
28	205.60	79.83	21.99	103.79	91	205.36	79.65	22.00	103.70	154	204.97	79.88	21.71	103.38						
29	205.18	79.88	21.84	103.47	92	205.88	79.73	21.99	104.16	155	204.75	79.50	22.00	103.25						
30	204.09	79.39	21.87	102.83	93	205.00	79.76	21.77	103.47	156	205.20	79.72	21.91	103.58						
31	205.18	79.90	21.86	103.42	94	204.84	79.64	21.96	103.24	157	204.94	79.55	21.98	103.40						
32	205.04	79.64	21.90	103.50	95	205.27	79.70	21.87	103.70	158	204.93	79.51	22.01	103.41						
33	205.08	79.73	21.91	103.43	96	204.99	79.79	21.99	103.22	159	205.02	79.80	21.94	103.28						
34	205.11	79.81	21.85	103.45	97	201.66	78.28	21.40	101.98	160	205.42	79.91	21.93	103.57						
35	205.18	79.67	21.84	103.68	98	208.68	81.17	22.26	105.25	161	204.79	79.59	21.73	103.47						
36	205.52	79.71	22.04	103.78	99	205.03	79.82	22.00	103.22	162	205.53	79.60	21.95	103.97						
37	205.24	79.55	21.92	103.77	100	204.95	79.62	21.93	103.40	163	205.42	79.60	21.87	103.95						
38	204.57	79.44	21.88	103.25	101	205.11	79.70	21.88	103.53	164	205.54	79.73	21.88	103.93						
39	205.41	79.78	21.93	103.70	102	204.89	79.79	21.85	103.26	165	205.34	79.79	21.89	103.66						
40	205.37	79.61	22.06	103.70	103	204.88	79.69	21.96	103.23	166	204.57	79.56	21.75	103.27						
41	205.33	79.73	21.97	103.63	104	204.73	79.72	21.78	103.23	167	204.76	79.52	21.87	103.37						
42	205.00	79.45	21.91	103.64	105	205.08	79.69	21.91	103.48	168	205.66	79.79	22.07	103.81						
43	205.33	79.68	22.00	103.65	106	205.17	79.67	22.09	103.42	169	204.91	79.69	21.90	103.32						
44	204.90	79.43	21.86	103.61	107	205.52	79.80	22.03	103.69	170	205.09	79.66	21.90	103.54						
45	205.16	79.90	22.06	103.20	108	205.29	79.66	21.90	103.73	171	205.56	79.63	22.04	103.89						
46	204.71	79.52	21.85	103.34	109	205.31	79.71	21.82	103.78	172	204.92	79.70	21.78	103.44						
47	204.80	79.54	21.87	103.40	110	205.52	79.77	21.87	103.88	173	205.19	79.93	21.90	103.36						
48	204.91	79.76	22.00	103.16	111	204.94	79.75	21.81	103.39	174	206.04	79.85	22.12	104.07						
49	204.94	79.54	21.94	103.45	112	205.81	79.72	22.10	103.99	175	204.34	79.39	21.77	103.19						
50	201.94	78.35	21.51	102.09	113	205.30	79.67	21.89	103.74	176	206.02	80.04	22.03	103.95						
51	208.65	80.96	22.27	105.42	114	205.38	79.82	21.82	103.74	177	205.41	79.88	22.00	103.53						
52	205.21	79.58	21.97	103.65	115	205.08	79.62	21.74	103.71	178	205.20	79.60	21.94	103.67						
53	205.15	79.79	22.08	103.29	116	205.51	79.64	21.95	103.92	179	204.73	79.66	21.82	103.25						
54	205.74	79.90	21.90	103.93	117	205.55	79.78	22.04	103.73	180	205.04	79.72	21.98	103.34						
55	204.61	79.63	21.78	103.21	118	205.42	79.52	21.92	103.98	181	205.40	79.52	21.89	103.99						
56	205.41	79.61	22.00	103.80	119	205.19	79.81	21.83	103.55	182	205.27	79.86	21.93	103.49						
57	205.20	79.62	21.88	103.70	120	204.57	79.56	21.78	103.23											
58	205.29	79.76	21.85	103.67	121	205.63	79.76	22.00	103.88											
59	205.46	79.88	21.97	103.61	122	205.01	79.57	21.91	103.53											
60	205.43	79.81	21.94	103.68	123	205.06	79.56	21.86	103.64											
61	205.10	79.73	21.95	103.43	124	204.68	79.65	21.94	103.09											
62	205.78	79.90	21.93	103.95	125	205.48	79.75	22.05	103.67											

Sustainability – Data Rate Distribution Graph

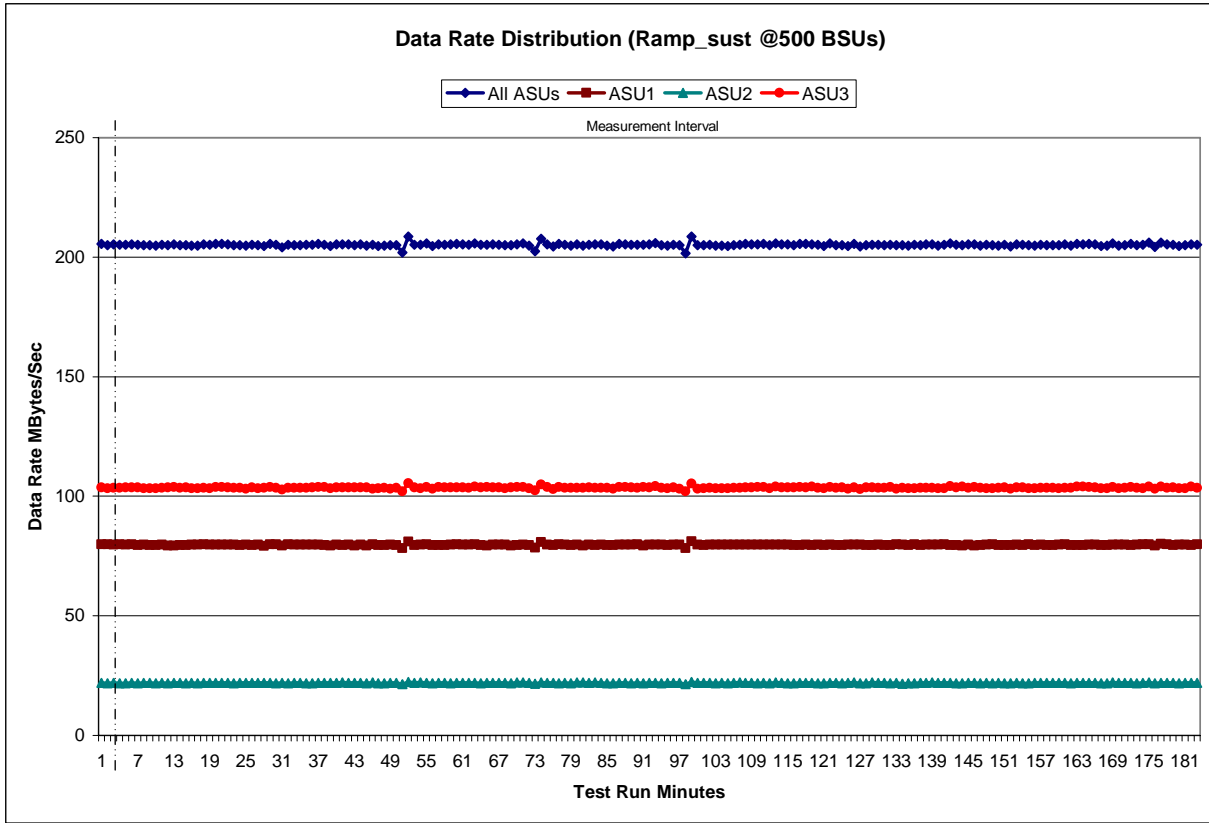

Sustainability – I/O Request Throughput Distribution Graph

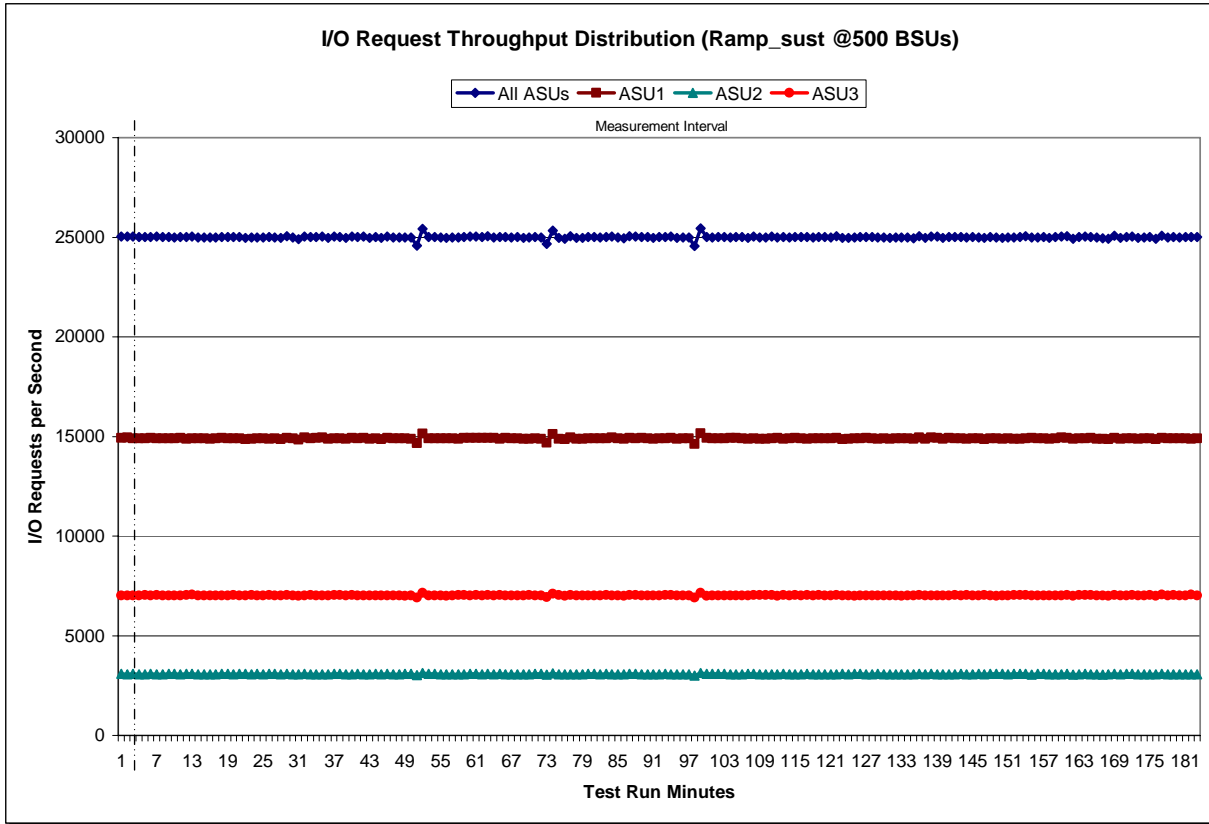

Sustainability – Average Response Time (ms) Distribution Data

Ramp-Up/Start-Up Measurement Interval		Start	Stop	Interval	Duration															
		19:51:08	19:54:08	0-2	0:03:00															
		19:54:08	22:54:08	3-182	3:00:00															
Interval	All ASUs	ASU1	ASU2	ASU3	Interval	All ASUs	ASU1	ASU2	ASU3	Interval	All ASUs	ASU1	ASU2	ASU3						
0	28.92	37.57	34.16	8.21	63	27.20	34.33	33.85	9.13	126	26.19	32.68	33.77	9.05						
1	27.49	34.87	34.25	8.84	64	23.38	29.23	31.76	7.35	127	23.09	28.78	31.65	7.27						
2	24.81	31.37	32.19	7.68	65	25.26	31.70	33.06	8.19	128	23.81	29.81	32.21	7.43						
3	26.15	33.18	33.46	8.04	66	23.40	29.15	31.76	7.57	129	27.68	35.37	33.63	8.76						
4	24.73	31.34	32.19	7.48	67	25.11	31.56	32.84	8.04	130	23.56	29.24	32.42	7.66						
5	24.78	31.45	32.74	7.12	68	25.14	31.75	32.29	8.03	131	24.00	30.38	31.78	7.05						
6	28.39	36.49	34.18	8.71	69	24.09	30.16	32.62	7.55	132	26.46	33.23	33.82	8.83						
7	25.28	31.86	33.06	7.89	70	25.43	31.94	33.09	8.24	133	25.17	31.42	33.11	8.41						
8	27.15	34.94	33.42	7.89	71	24.23	30.44	32.34	7.49	134	22.52	27.79	31.83	7.27						
9	27.91	35.62	33.82	8.91	72	32.80	43.13	37.59	8.80	135	24.82	31.22	32.59	7.84						
10	25.36	32.10	32.95	7.70	73	27.48	34.80	34.44	8.87	136	26.78	33.55	33.98	9.25						
11	23.58	29.53	31.94	7.33	74	25.52	32.16	33.04	8.17	137	22.25	27.68	31.34	6.69						
12	26.17	33.37	32.71	8.11	75	23.06	28.87	31.50	7.00	138	25.66	32.54	32.62	7.98						
13	26.90	34.14	33.82	8.48	76	24.56	30.52	33.14	8.13	139	24.68	30.42	33.98	8.45						
14	24.25	30.60	32.07	7.35	77	25.22	31.52	33.32	8.31	140	23.41	28.94	32.32	7.77						
15	27.54	35.38	33.15	8.48	78	22.26	27.79	31.84	6.34	141	23.70	29.71	31.88	7.44						
16	26.57	33.29	33.99	9.06	79	27.72	35.12	34.07	9.19	142	25.18	31.34	33.35	8.53						
17	22.44	27.87	31.47	6.94	80	23.82	29.60	32.54	7.73	143	24.80	31.32	32.50	7.66						
18	26.16	33.13	33.30	8.21	81	22.82	28.39	31.92	7.04	144	22.99	28.61	31.97	7.13						
19	26.78	33.91	33.81	8.61	82	26.11	32.70	33.62	8.88	145	25.60	32.03	33.31	8.56						
20	25.18	32.00	32.42	7.54	83	26.38	33.23	33.84	8.51	146	23.05	28.66	32.13	7.24						
21	23.81	29.68	32.48	7.59	84	25.03	31.56	32.39	7.97	147	26.47	33.76	32.93	8.12						
22	28.17	35.97	34.20	9.01	85	24.78	31.31	32.26	7.62	148	26.13	32.83	33.56	8.57						
23	25.88	32.92	32.48	8.02	86	26.99	34.52	33.05	8.37	149	21.39	26.47	31.23	6.27						
24	23.99	30.21	31.95	7.28	87	24.64	30.70	32.79	8.27	150	24.28	30.27	32.40	8.01						
25	29.29	37.60	34.12	9.62	88	26.58	33.49	33.81	8.76	151	24.15	29.96	32.78	8.06						
26	25.88	32.65	33.79	8.01	89	28.99	37.20	34.00	9.36	152	23.87	29.57	32.76	7.92						
27	24.08	30.20	32.69	7.36	90	29.65	38.15	34.78	9.43	153	22.39	27.71	31.92	6.93						
28	31.90	42.22	36.15	8.15	91	25.97	32.83	32.96	8.38	154	26.12	33.13	32.82	8.28						
29	26.57	33.64	33.12	8.67	92	24.45	31.03	31.96	7.23	155	24.14	30.20	32.18	7.76						
30	26.81	33.83	33.66	8.88	93	28.77	36.68	34.28	9.56	156	22.26	27.65	31.55	6.76						
31	24.53	31.30	32.00	6.86	94	26.80	33.97	33.58	8.64	157	26.96	33.82	33.59	9.51						
32	30.04	38.83	34.55	9.44	95	27.57	35.08	33.92	8.90	158	22.78	28.04	32.02	7.58						
33	28.84	37.01	34.33	9.05	96	29.70	38.33	34.45	9.26	159	24.78	31.20	32.55	7.74						
34	26.08	33.24	32.81	7.87	97	26.91	33.96	33.89	8.92	160	24.53	30.48	32.89	8.26						
35	24.98	31.65	32.76	7.42	98	27.34	34.81	34.58	8.31	161	25.06	31.37	32.85	8.27						
36	24.63	31.11	32.48	7.46	99	24.79	31.44	32.20	7.35	162	22.94	28.68	31.69	6.97						
37	25.16	31.38	33.38	8.40	100	28.32	36.24	34.26	8.92	163	25.04	31.32	32.78	8.36						
38	22.73	28.20	32.51	6.85	101	24.89	31.49	32.16	7.73	164	27.16	33.93	34.38	9.65						
39	26.34	33.33	33.05	8.59	102	25.69	32.35	33.42	8.14	165	23.12	28.86	31.83	7.15						
40	23.18	28.97	31.63	7.18	103	28.57	36.68	33.70	9.09	166	26.35	32.88	33.58	9.35						
41	25.17	31.72	32.65	7.98	104	25.96	32.85	32.97	8.25	167	24.69	30.77	32.86	8.22						
42	26.43	33.38	33.25	8.67	105	23.49	29.60	31.80	6.86	168	22.15	27.87	31.03	6.16						
43	25.26	31.49	33.39	8.43	106	24.02	30.06	32.12	7.67	169	26.57	33.68	33.69	8.35						
44	22.48	28.09	31.16	6.80	107	24.22	30.38	32.51	7.52	170	25.56	32.24	32.82	8.23						
45	25.82	32.67	32.78	8.21	108	22.98	28.52	32.09	7.29	171	26.95	34.11	33.11	9.13						
46	26.09	33.08	32.82	8.30	109	25.67	32.22	33.42	8.42	172	25.17	31.87	33.43	7.39						
47	22.78	28.45	31.76	6.81	110	28.19	35.77	34.55	9.34	173	26.26	33.21	33.22	8.45						
48	25.35	31.97	32.66	8.05	111	22.76	28.37	31.69	6.90	174	25.34	31.77	32.98	8.41						
49	26.56	33.26	33.99	9.10	112	24.83	31.02	32.90	8.19	175	24.76	30.90	32.91	8.16						
50	24.89	31.53	32.81	7.31	113	24.84	31.22	32.38	8.04	176	23.45	29.48	31.93	6.95						
51	29.69	38.58	34.77	8.62	114	23.86	29.97	32.02	7.34	177	25.97	32.98	32.82	8.10						
52	25.06	31.64	32.92	7.64	115	24.44	30.73	32.42	7.62	178	24.17	30.00	32.58	8.15						
53	26.83	33.95	33.76	8.66	116	25.15	31.55	32.77	8.27	179	21.83	27.17	30.86	6.53						
54	22.53	28.12	31.66	6.68	117	23.52	29.17	32.09	7.79	180	26.92	34.06	33.23	8.99						
55	25.37	32.24	32.35	7.72	118	24.05	30.19	32.34	7.42	181	24.03	29.87	32.40	8.05						
56	28.10	35.72	33.58	9.54	119	26.81	33.62	33.90	9.21	182	22.58	27.86	32.31	7.13						
57	23.89	29.86	32.34	7.58	120	24.56	30.54	32.96	8.21	Average	25.30	31.87	32.90	8.03						
58	25.06	31.72	32.53	7.69	121	22.55	28.34	31.40	6.42											
59	24.49	30.77	32.85	7.50	122	26.03	32.69	33.33	8.74											
60	25.42	31.71	33.11	8.71	123	22.63	28.01	31.77	7.26											
61	25.33	31.67	33.00	8.51	124	23.24	28.89	31.91	7.37											
62	24.22	30.34	32.94	7.41	125	25.68	32.36	33.11	8.23											

Sustainability – Average Response Time (ms) Distribution Graph

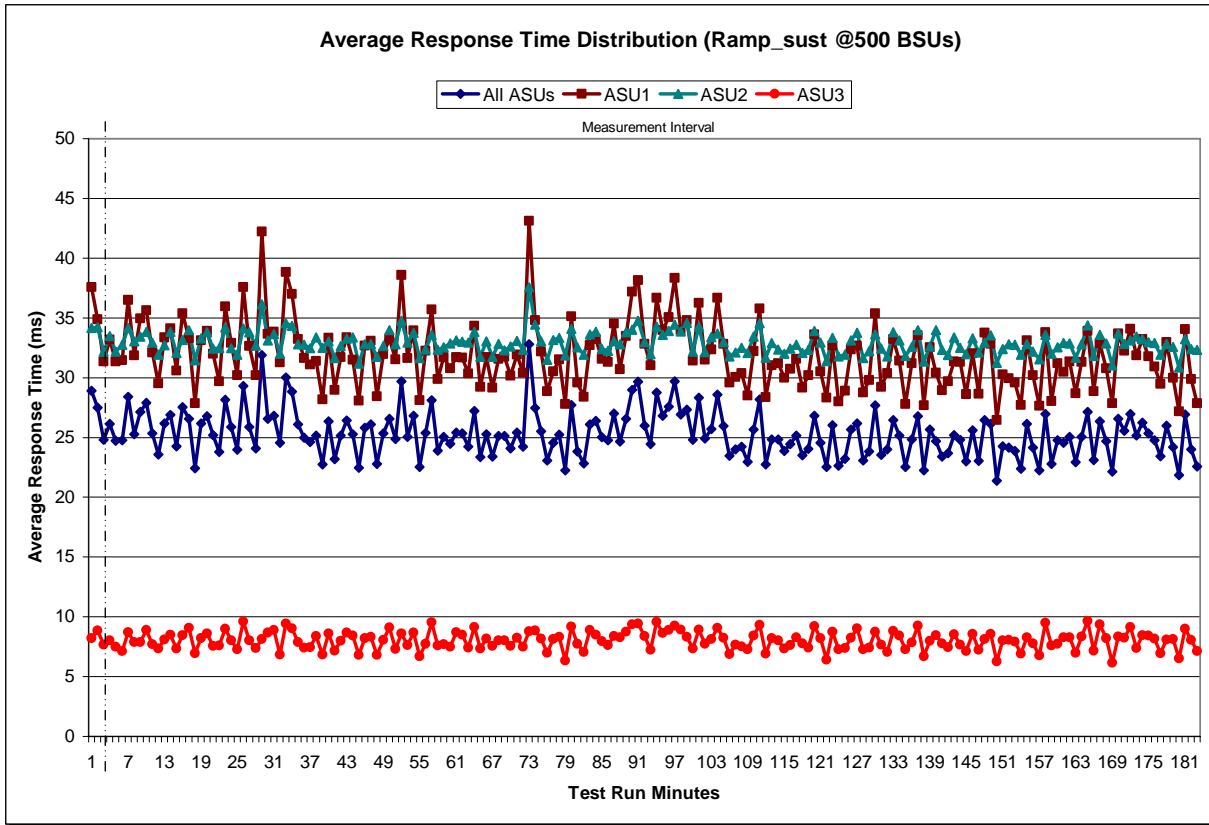

Sustainability – Response Time Frequency Distribution Data

Response Time (ms)	0-0.25	>0.25-0.5	>0.5-0.75	>0.75-1.0	>1.0-1.25	>1.25-1.5	>1.5-1.75	>1.75-2.0
Read	81,274	3,535,404	5,083,942	2,335,773	1,235,285	713,279	436,845	301,457
Write	-	1,246	186,751	1,271,384	3,825,483	5,977,429	6,347,166	5,595,937
All ASUs	81,274	3,536,650	5,270,693	3,607,157	5,060,768	6,690,708	6,784,011	5,897,394
ASU1	57,306	2,457,641	3,535,855	1,618,470	846,826	484,411	295,090	203,916
ASU2	23,968	1,077,763	1,548,087	717,303	388,459	228,868	141,757	97,546
ASU3	-	1,246	186,751	1,271,384	3,825,483	5,977,429	6,347,164	5,595,932
Response Time (ms)	>2.0-2.5	>2.5-3.0	>3.0-3.5	>3.5-4.0	>4.0-4.5	>4.5-5.0	>5.0-6.0	>6.0-7.0
Read	502,786	420,246	494,639	547,541	771,821	903,366	2,650,606	3,511,448
Write	10,378,976	5,238,257	4,382,165	2,984,860	2,965,351	2,217,945	3,321,368	2,890,346
All ASUs	10,881,762	5,658,503	4,876,804	3,532,401	3,737,172	3,121,311	5,971,974	6,401,794
ASU1	354,278	321,796	410,930	478,585	701,608	841,407	2,553,556	3,542,483
ASU2	148,577	98,854	85,944	75,555	87,681	93,742	271,212	414,322
ASU3	10,378,907	5,237,853	4,379,930	2,978,261	2,947,883	2,186,162	3,147,206	2,444,989
Response Time (ms)	>7.0-8.0	>8.0-9.0	>9.0-10.0	>10.0-15.0	>15.0-20.0	>20.0-25.0	>25.0-30.0	>30.0
Read	4,012,787	4,171,868	4,074,699	16,928,650	11,697,871	8,588,252	6,531,544	26,970,404
Write	2,532,002	2,663,190	2,701,561	14,085,871	13,382,908	11,676,904	9,868,953	49,007,808
All ASUs	6,544,789	6,835,058	6,776,260	31,014,521	25,080,779	20,265,156	16,400,497	75,978,212
ASU1	4,290,313	4,734,333	4,934,282	23,545,827	19,368,386	15,556,446	12,508,609	57,288,529
ASU2	559,038	681,321	768,754	3,719,302	3,134,146	2,697,836	2,363,819	13,787,118
ASU3	1,695,438	1,419,404	1,073,224	3,749,392	2,578,247	2,010,874	1,528,069	4,902,565

Sustainability – Response Time Frequency Distribution Graph

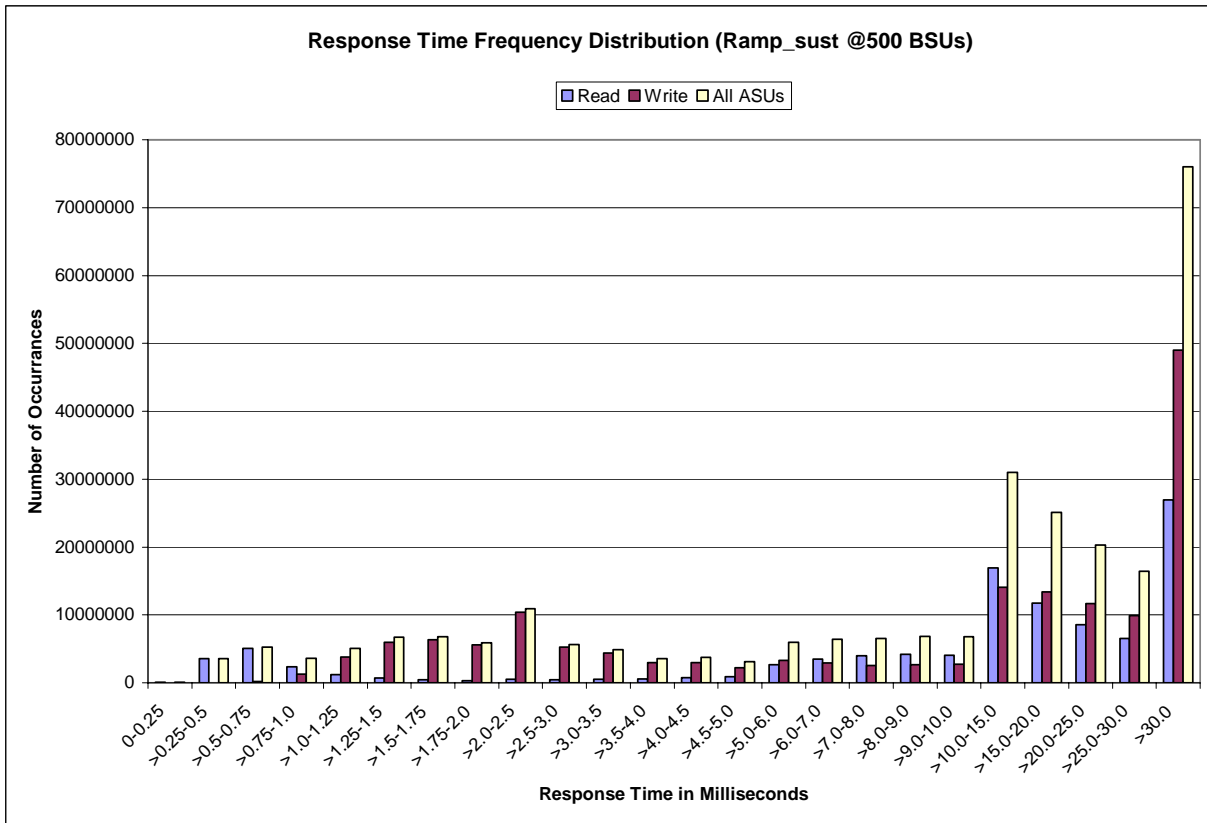

Sustainability – Measured Intensity Multiplier and Coefficient of Variation

Clause 3.4.3

IM – Intensity Multiplier: *The ratio of I/Os for each I/O stream relative to the total I/Os for all I/O streams (ASU1-1 – ASU3-1) as required by the benchmark specification.*

Clauses 5.1.0 and 5.3.13.2

MIM – Measured Intensity Multiplier: *The Measured Intensity Multiplier represents the ratio of measured I/Os for each I/O stream relative to the total I/Os measured for all I/O streams (ASU1-1 – ASU3-1). This value may differ from the corresponding Expected Intensity Multiplier by no more than 5%.*

Clause 5.3.13.3

COV – Coefficient of Variation: *This measure of variation for the Measured Intensity Multiplier cannot exceed 0.2.*

	ASU1-1	ASU1-2	ASU1-3	ASU1-4	ASU2-1	ASU2-2	ASU2-3	ASU3-1
IM	0.0350	0.2810	0.0700	0.2100	0.0180	0.0700	0.0350	0.2810
MIM	0.0350	0.2810	0.0700	0.2100	0.0180	0.0700	0.0350	0.2810
COV	0.004	0.001	0.003	0.002	0.006	0.003	0.004	0.001

Primary Metrics Test – IOPS Test Phase

Clause 5.4.2.2

The IOPS Test Phase consists of one Test Run at the 100% load point with a Measurement Interval of ten (10) minutes. The IOPS Test Phase immediately follows the Sustainability Test Phase without any interruption or manual intervention.

The IOPS Test Run generates the SPC-1 IOPS™ primary metric, which is computed as the I/O Request Throughput for the Measurement Interval of the IOPS Test Run.

The Average Response Time is computed for the IOPS Test Run and cannot exceed 30 milliseconds. If the Average Response Time exceeds the 30 millisecond constraint, the measurement is invalid.

Clause 9.2.4.7.2

For the IOPS Test Phase the FDR shall contain:

- 1. I/O Request Throughput Distribution (data and graph).*
- 2. A Response Time Frequency Distribution.*
- 3. An Average Response Time Distribution.*
- 4. The human readable Test Run Results File produced by the Workload Generator.*
- 5. A listing or screen image of all input parameters supplied to the Workload Generator.*
- 6. The total number of I/O Requests completed in the Measurement Interval as well as the number of I/O Requests with a Response Time less than or equal to 30 milliseconds and the number of I/O Requests with a Response Time greater than 30 milliseconds.*

SPC-1 Workload Generator Input Parameters

The SPC-1 Workload Generator input parameters for the Sustainability, IOPS, Response Time Ramp, Repeatability, and Persistence Test Runs are documented in “Appendix E: SPC-1 Workload Generator Input Parameters” on Page 67.

IOPS Test Results File

A link to the test results file generated from the IOPS Test Run is listed below.

[IOPS Test Results File](#)

IOPS Test Run – I/O Request Throughput Distribution Data

500 BSUs	Start	Stop	Interval	Duration
<i>Start-Up/Ramp-Up</i>	22:54:12	22:57:13	0-2	0:03:01
<i>Measurement Interval</i>	22:57:13	23:07:13	3-12	0:10:00
60 second intervals	All ASUs	ASU1	ASU2	ASU3
0	25,026.02	14,923.05	3,079.25	7,023.72
1	24,996.78	14,882.62	3,081.32	7,032.85
2	25,001.03	14,907.60	3,075.50	7,017.93
3	24,987.02	14,879.68	3,071.68	7,035.65
4	24,990.27	14,875.22	3,083.47	7,031.58
5	25,008.80	14,903.45	3,074.07	7,031.28
6	24,974.47	14,872.65	3,081.97	7,019.85
7	25,032.88	14,923.03	3,078.28	7,031.57
8	24,993.55	14,875.53	3,086.60	7,031.42
9	24,937.08	14,875.82	3,061.32	6,999.95
10	25,067.32	14,929.17	3,101.45	7,036.70
11	24,948.83	14,859.12	3,078.75	7,010.97
12	25,034.63	14,909.07	3,086.48	7,039.08
Average	24,997.49	14,890.27	3,080.41	7,026.81

IOPS Test Run – I/O Request Throughput Distribution Graph

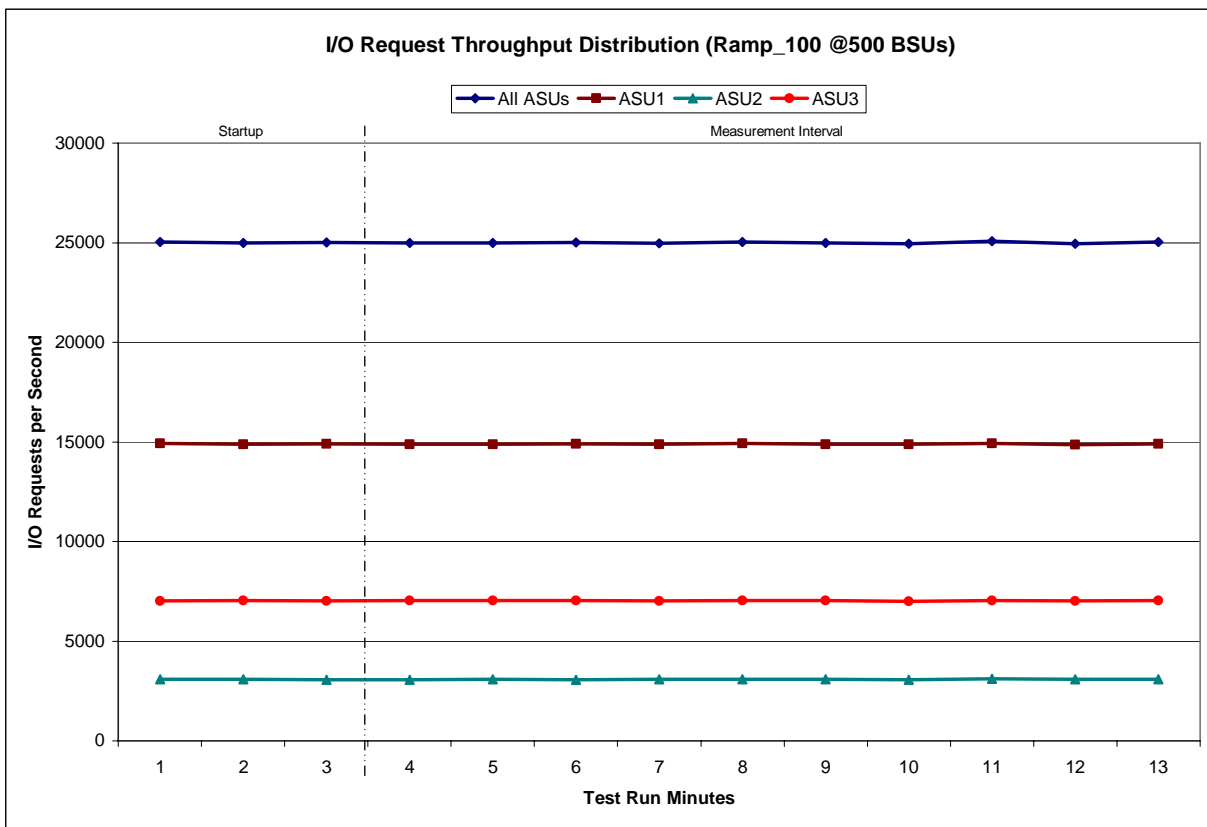

IOPS Test Run – Average Response Time (ms) Distribution Data

500 BSUs	Start	Stop	Interval	Duration
Start-Up/Ramp-Up	22:54:12	22:57:13	0-2	0:03:01
Measurement Interval	22:57:13	23:07:13	3-12	0:10:00
60 second intervals	All ASUs	ASU1	ASU2	ASU3
0	21.23	26.32	31.87	5.74
1	24.96	31.19	32.88	8.31
2	23.33	28.98	32.06	7.50
3	22.49	27.72	31.74	7.38
4	25.26	31.79	32.95	8.08
5	25.89	32.46	33.39	8.68
6	26.34	32.94	33.52	9.20
7	20.74	25.71	30.41	5.96
8	26.60	33.58	33.37	8.86
9	24.42	30.49	32.30	8.06
10	21.90	27.35	31.17	6.26
11	24.37	30.03	33.02	8.57
12	23.15	28.53	32.26	7.76
Average	24.12	30.06	32.41	7.88

IOPS Test Run – Average Response Time (ms) Distribution Graph

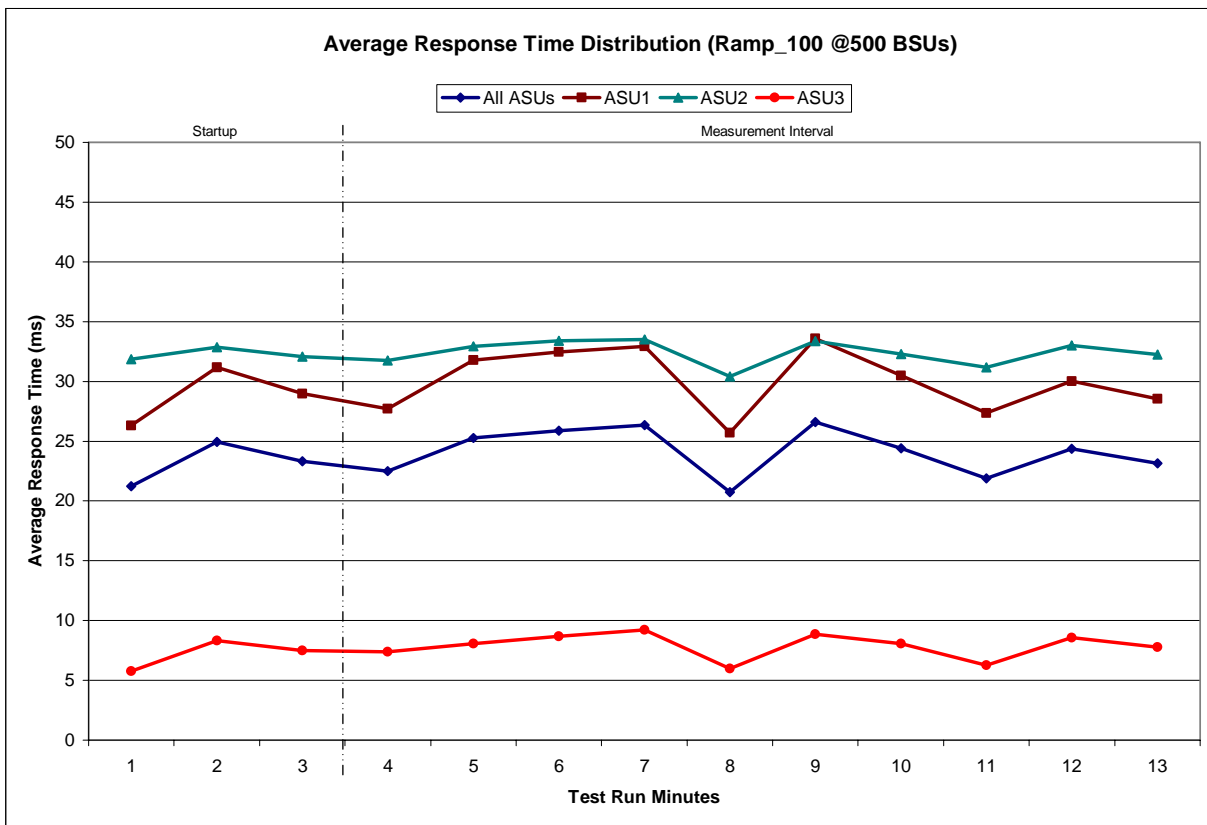

IOPS Test Run – Response Time Frequency Distribution Data

Response Time (ms)	0-0.25	>0.25-0.5	>0.5-0.75	>0.75-1.0	>1.0-1.25	>1.25-1.5	>1.5-1.75	>1.75-2.0
Read	4616	202,451	287,303	132,963	70,496	40,736	24,615	16,827
Write	0	8	9,340	71,025	220,168	336,392	354,594	313,686
All ASUs	4616	202,459	296,643	203,988	290,664	377,128	379,209	330,513
ASU1	3310	141,842	201,608	92,755	48,886	28,077	16,792	11,502
ASU2	1306	60,609	85,695	40,208	21,610	12,659	7,823	5,325
ASU3	0	8	9,340	71,025	220,168	336,392	354,594	313,686
Response Time (ms)	>2.0-2.5	>2.5-3.0	>3.0-3.5	>3.5-4.0	>4.0-4.5	>4.5-5.0	>5.0-6.0	>6.0-7.0
Read	27,723	23,194	27,374	29,796	41,633	49,124	142,998	190,718
Write	575,235	292,413	246,895	166,584	165,020	124,604	182,771	156,226
All ASUs	602,958	315,607	274,269	196,380	206,653	173,728	325,769	346,944
ASU1	19,793	17,881	22,789	25,948	37,856	45,824	137,882	192,443
ASU2	7,933	5,346	4,700	4,172	4,690	5,061	14,394	22,088
ASU3	575,232	292,380	246,780	166,260	164,107	122,843	173,493	132,413
Response Time (ms)	>7.0-8.0	>8.0-9.0	>9.0-10.0	>10.0-15.0	>15.0-20.0	>20.0-25.0	>25.0-30.0	>30.0
Read	218,673	228,258	222,799	942,512	664,850	491,520	373,920	1,457,346
Write	137,229	144,330	146,851	770,514	744,535	660,553	561,968	2,704,497
All ASUs	355,902	372,588	369,650	1,713,026	1,409,385	1,152,073	935,888	4,161,843
ASU1	234,142	258,684	269,969	1,306,774	1,093,141	886,883	715,049	3,123,860
ASU2	29,755	36,100	41,164	203,284	175,491	152,234	134,955	771,554
ASU3	92,005	77,804	58,517	202,968	140,753	112,956	85,884	266,429

IOPS Test Run –Response Time Frequency Distribution Graph

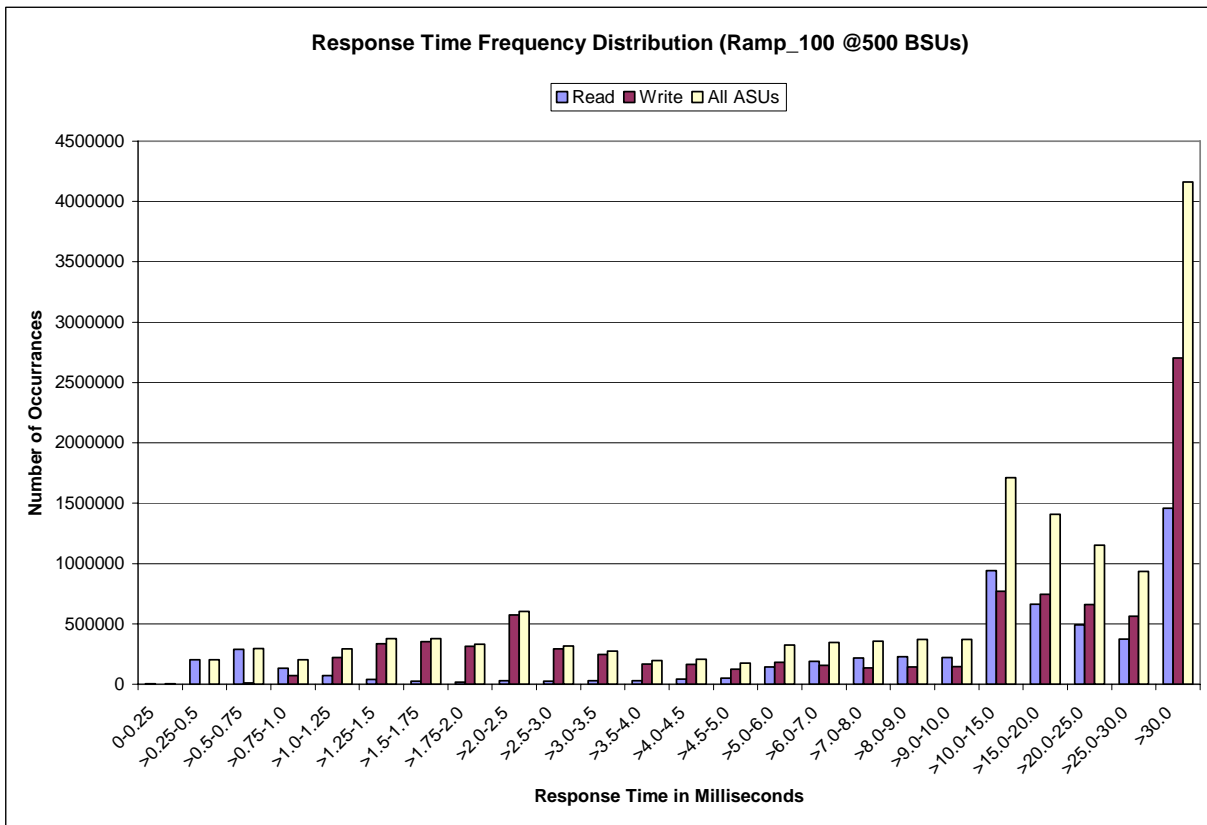

IOPS Test Run – I/O Request Information

I/O Requests Completed in the Measurement Interval	I/O Requests Completed with Response Time = or < 30 ms	I/O Requests Completed with Response Time > 30 ms
14,997,883	10,836,040	4,161,843

IOPS Test Run – Measured Intensity Multiplier and Coefficient of Variation

Clause 3.4.3

IM – Intensity Multiplier: The ratio of I/Os for each I/O stream relative to the total I/Os for all I/O streams (ASU1-1 – ASU3-1) as required by the benchmark specification.

Clauses 5.1.0 and 5.3.13.2

MIM – Measured Intensity Multiplier: The Measured Intensity Multiplier represents the ratio of measured I/Os for each I/O stream relative to the total I/Os measured for all I/O streams (ASU1-1 – ASU3-1). This value may differ from the corresponding Expected Intensity Multiplier by no more than 5%.

Clause 5.3.13.3

COV – Coefficient of Variation: This measure of variation for the Measured Intensity Multiplier cannot exceed 0.2.

	ASU1-1	ASU1-2	ASU1-3	ASU1-4	ASU2-1	ASU2-2	ASU2-3	ASU3-1
IM	0.0350	0.2810	0.0700	0.2100	0.0180	0.0700	0.0350	0.2810
MIM	0.0350	0.2809	0.0700	0.2098	0.0180	0.0701	0.0350	0.2811
COV	0.005	0.001	0.002	0.001	0.005	0.004	0.005	0.001

Primary Metrics Test – Response Time Ramp Test Phase

Clause 5.4.2.3

The Response Time Ramp Test Phase consists of five Test Runs, one each at 95%, 90%, 80%, 50%, and 10% of the load point (100%) used to generate the SPC-1 IOPS™ primary metric. Each of the five Test Runs has a Measurement Interval of ten (10) minutes. The Response Time Ramp Test Phase immediately follows the IOPS Test Phase without any interruption or manual intervention.

The five Response Time Ramp Test Runs, in conjunction with the IOPS Test Run (100%), demonstrate the relationship between Average Response Time and I/O Request Throughput for the Tested Storage Configuration (TSC) as illustrated in the response time/throughput curve on page 12.

In addition, the Average Response Time measured during the 10% Test Run is the value for the SPC-1 LRT™ metric. That value represents the Average Response Time of a lightly loaded TSC.

Clause 9.2.4.7.3

The following content shall appear in the FDR for the Response Time Ramp Phase:

- 1. A Response Time Ramp Distribution.*
- 2. The human readable Test Run Results File produced by the Workload Generator for each Test Run within the Response Time Ramp Test Phase.*
- 3. For the 10% Load Level Test Run (SPC-1 LRT™ metric) an Average Response Time Distribution.*
- 4. A listing or screen image of all input parameters supplied to the Workload Generator.*

SPC-1 Workload Generator Input Parameters

The SPC-1 Workload Generator input parameters for the Sustainability, IOPS, Response Time Ramp, Repeatability, and Persistence Test Runs are documented in “Appendix E: SPC-1 Workload Generator Input Parameters” on Page 67.

Response Time Ramp Test Results File

A link to each test result file generated from each Response Time Ramp Test Run list listed below.

[95% Load Level](#)

[90% Load Level](#)

[80% Load Level](#)

[50% Load Level](#)

[10% Load Level](#)

Response Time Ramp Distribution (IOPS) Data

The five Test Runs that comprise the Response Time Ramp Phase are executed at 95%, 90%, 80%, 50%, and 10% of the Business Scaling Unit (BSU) load level used to produce the SPC-1 IOPS™ primary metric. The 100% BSU load level is included in the following Response Time Ramp data tables and graphs for completeness.

100% Load Level - 500 BSUs					95% Load Level - 475 BSUs				
Start	Stop	Interval	Duration		Start	Stop	Interval	Duration	
22:54:12	22:57:13	0-2	0:03:01		23:07:16	23:10:17	0-2	0:03:01	
22:57:13	23:07:13	3-12	0:10:00		23:10:17	23:20:17	3-12	0:10:00	
<i>(60 second intervals)</i>					<i>(60 second intervals)</i>				
All ASUs	ASU-1	ASU-2	ASU-3		All ASUs	ASU-1	ASU-2	ASU-3	
0	25,026.02	14,923.05	3,079.25	7,023.72	0	23,772.43	14,172.77	2,933.40	6,666.27
1	24,996.78	14,882.62	3,081.32	7,032.85	1	23,746.40	14,159.90	2,918.92	6,667.58
2	25,001.03	14,907.60	3,075.50	7,017.93	2	23,753.30	14,156.65	2,918.58	6,678.07
3	24,987.02	14,879.68	3,071.68	7,035.65	3	23,763.42	14,152.75	2,927.12	6,683.55
4	24,990.27	14,875.22	3,083.47	7,031.58	4	23,779.80	14,162.17	2,925.75	6,691.88
5	25,008.80	14,903.45	3,074.07	7,031.28	5	23,749.93	14,139.93	2,927.90	6,682.10
6	24,974.47	14,872.65	3,081.97	7,019.85	6	23,775.80	14,175.70	2,919.52	6,680.58
7	25,032.88	14,923.03	3,078.28	7,031.57	7	23,781.95	14,179.42	2,917.17	6,685.37
8	24,993.55	14,875.53	3,086.60	7,031.42	8	23,752.30	14,165.97	2,916.48	6,669.85
9	24,937.08	14,875.82	3,061.32	6,999.95	9	23,732.47	14,133.50	2,926.75	6,672.22
10	25,067.32	14,929.17	3,101.45	7,036.70	10	23,769.52	14,175.57	2,915.23	6,678.72
11	24,948.83	14,859.12	3,078.75	7,010.97	11	23,752.82	14,134.75	2,939.42	6,678.65
12	25,034.63	14,909.07	3,086.48	7,039.08	12	23,712.07	14,145.65	2,911.87	6,654.55
Average	24,997.49	14,890.27	3,080.41	7,026.81	Average	23,757.01	14,156.54	2,922.72	6,677.75
90% Load Level - 450 BSUs					80% Load Level - 400 BSUs				
Start	Stop	Interval	Duration		Start	Stop	Interval	Duration	
23:20:20	23:23:21	0-2	0:03:01		23:33:24	23:36:25	0-2	0:03:01	
23:23:21	23:33:21	3-12	0:10:00		23:36:25	23:46:25	3-12	0:10:00	
<i>(60 second intervals)</i>					<i>(60 second intervals)</i>				
All ASUs	ASU-1	ASU-2	ASU-3		All ASUs	ASU-1	ASU-2	ASU-3	
0	22,498.60	13,390.72	2,772.28	6,335.60	0	19,990.50	11,901.35	2,463.17	5,625.98
1	22,505.15	13,411.23	2,770.38	6,323.53	1	19,976.12	11,894.77	2,454.75	5,626.60
2	22,480.27	13,403.13	2,762.95	6,314.18	2	19,978.77	11,887.58	2,465.78	5,625.40
3	22,484.83	13,406.93	2,757.98	6,319.92	3	19,979.05	11,897.75	2,461.02	5,620.28
4	22,498.97	13,396.30	2,762.82	6,339.85	4	20,043.68	11,938.48	2,472.03	5,633.17
5	22,472.52	13,388.52	2,765.03	6,318.97	5	19,984.03	11,901.48	2,447.50	5,635.05
6	22,502.32	13,418.12	2,765.73	6,318.47	6	19,982.63	11,906.30	2,458.07	5,618.27
7	22,476.90	13,398.43	2,764.02	6,314.45	7	20,012.13	11,923.38	2,468.68	5,620.07
8	22,519.95	13,417.38	2,777.30	6,325.27	8	20,017.53	11,940.98	2,461.45	5,615.10
9	22,523.20	13,437.53	2,766.77	6,318.90	9	19,986.65	11,906.42	2,445.73	5,634.50
10	22,471.38	13,400.60	2,760.32	6,310.47	10	20,000.28	11,926.08	2,454.50	5,619.70
11	22,548.55	13,452.45	2,768.07	6,328.03	11	19,996.73	11,908.77	2,458.07	5,629.90
12	22,478.23	13,404.95	2,763.05	6,310.23	12	20,016.92	11,930.32	2,452.75	5,633.85
Average	22,497.69	13,412.12	2,765.11	6,320.46	Average	20,001.97	11,918.00	2,457.98	5,625.99
50% Load Level - 250 BSUs					10% Load Level - 50 BSUs				
Start	Stop	Interval	Duration		Start	Stop	Interval	Duration	
23:46:28	23:49:29	0-2	0:03:01		23:59:31	0:02:32	0-2	0:03:01	
23:49:29	23:59:29	3-12	0:10:00		0:02:32	0:12:32	3-12	0:10:00	
<i>(60 second intervals)</i>					<i>(60 second intervals)</i>				
All ASUs	ASU-1	ASU-2	ASU-3		All ASUs	ASU-1	ASU-2	ASU-3	
0	12,510.77	7,456.98	1,535.40	3,518.38	0	2,494.80	1,487.97	311.23	695.60
1	12,494.75	7,457.32	1,532.25	3,505.18	1	2,496.32	1,484.98	305.60	705.73
2	12,515.87	7,461.37	1,534.77	3,519.73	2	2,494.05	1,483.87	305.77	704.42
3	12,495.83	7,451.75	1,529.75	3,514.33	3	2,499.47	1,491.97	309.10	698.40
4	12,502.08	7,443.72	1,538.67	3,519.70	4	2,504.38	1,489.00	311.20	704.18
5	12,518.68	7,470.85	1,537.17	3,510.67	5	2,493.03	1,487.55	305.88	699.60
6	12,507.92	7,457.50	1,533.67	3,516.75	6	2,490.35	1,479.78	311.85	698.72
7	12,476.80	7,433.98	1,536.32	3,506.50	7	2,504.22	1,491.62	307.80	704.80
8	12,501.53	7,451.42	1,541.25	3,508.87	8	2,489.57	1,483.37	307.57	698.63
9	12,502.02	7,444.98	1,537.32	3,519.72	9	2,500.63	1,487.75	311.05	701.83
10	12,480.42	7,449.07	1,527.20	3,504.15	10	2,504.98	1,494.17	310.67	700.15
11	12,509.78	7,452.03	1,543.82	3,513.93	11	2,499.50	1,488.30	309.97	701.23
12	12,490.13	7,439.87	1,540.55	3,509.72	12	2,497.42	1,485.73	306.63	705.05
Average	12,498.52	7,449.52	1,536.57	3,512.43	Average	2,498.36	1,487.92	309.17	701.26

Response Time Ramp Distribution (IOPS) Graph

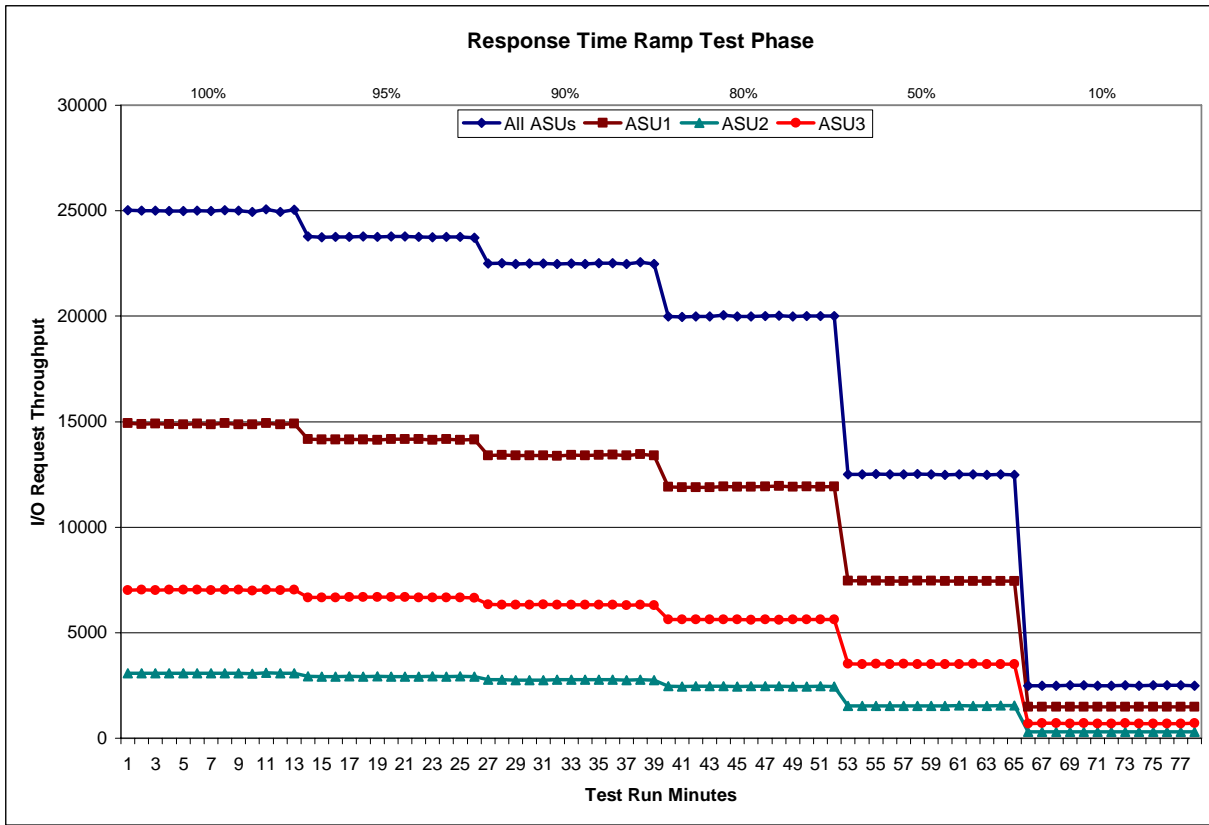

SPC-1 LRT™ Average Response Time (ms) Distribution Data

50 BSUs	Start	Stop	Interval	Duration
<i>Start-Up/Ramp-Up</i>	23:59:31	0:02:32	0-2	0:03:01
<i>Measurement Interval</i>	0:02:32	0:12:32	3-12	0:10:00
60 second intervals	All ASUs	ASU1	ASU2	ASU3
0	4.47	5.84	6.13	0.82
1	4.31	5.69	5.69	0.81
2	4.30	5.69	5.65	0.80
3	4.34	5.70	5.69	0.83
4	4.43	5.81	5.82	0.91
5	4.34	5.71	5.69	0.83
6	4.33	5.71	5.69	0.82
7	4.29	5.67	5.63	0.80
8	4.35	5.73	5.70	0.83
9	4.35	5.72	5.71	0.84
10	4.35	5.72	5.68	0.82
11	4.30	5.67	5.61	0.82
12	4.32	5.71	5.67	0.82
Average	4.34	5.71	5.69	0.83

SPC-1 LRT™ Average Response Time (ms) Distribution Graph

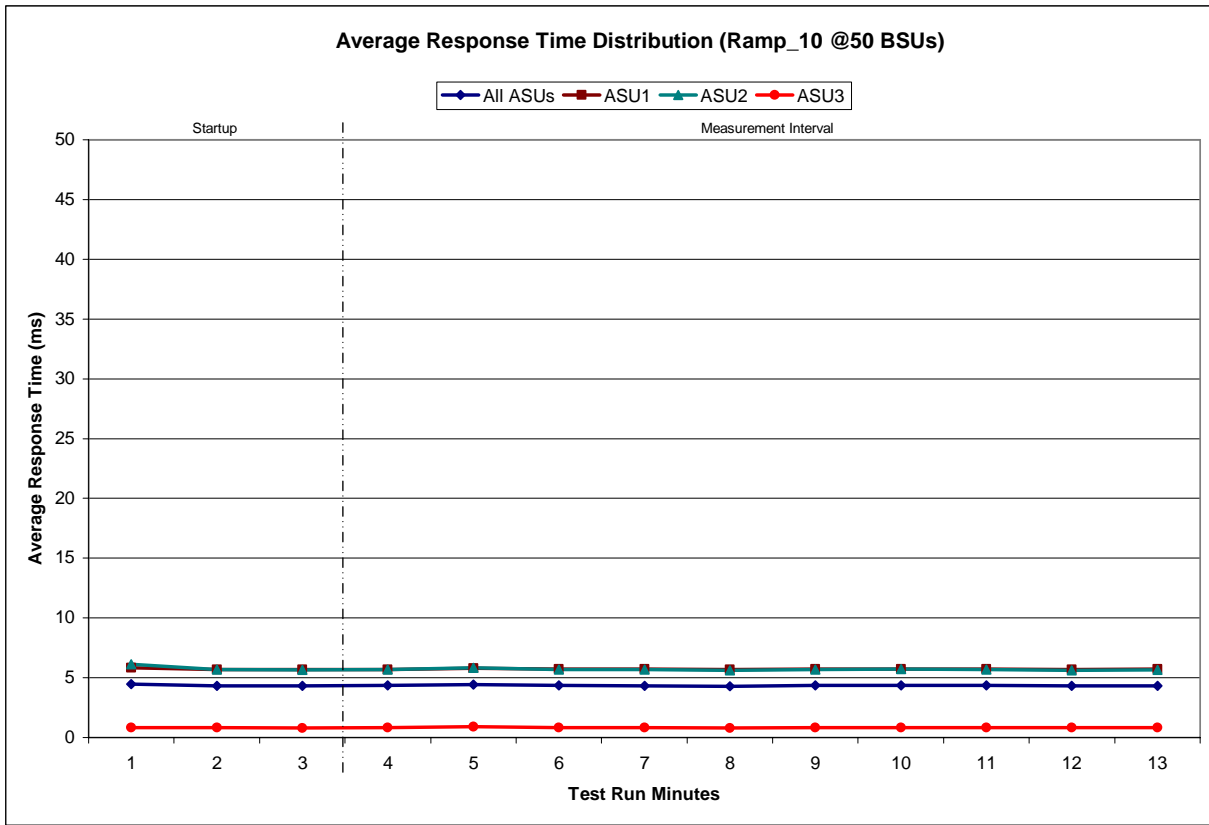

SPC-1 LRT™ (10%) – Measured Intensity Multiplier and Coefficient of Variation

Clause 3.4.3

IM – Intensity Multiplier: The ratio of I/Os for each I/O stream relative to the total I/Os for all I/O streams (ASU1-1 – ASU3-1) as required by the benchmark specification.

Clauses 5.1.0 and 5.3.13.2

MIM – Measured Intensity Multiplier: The Measured Intensity Multiplier represents the ratio of measured I/Os for each I/O stream relative to the total I/Os measured for all I/O streams (ASU1-1 – ASU3-1). This value may differ from the corresponding Expected Intensity Multiplier by no more than 5%.

Clause 5.3.13.3

COV – Coefficient of Variation: This measure of variation for the Measured Intensity Multiplier cannot exceed 0.2.

	ASU1-1	ASU1-2	ASU1-3	ASU1-4	ASU2-1	ASU2-2	ASU2-3	ASU3-1
IM	0.0350	0.2810	0.0700	0.2100	0.0180	0.0700	0.0350	0.2810
MIM	0.0349	0.2807	0.0702	0.2097	0.0181	0.0707	0.0349	0.2807
COV	0.010	0.004	0.009	0.004	0.023	0.009	0.009	0.003

Repeatability Test

Clause 5.4.5

The Repeatability Test demonstrates the repeatability and reproducibility of the SPC-1 IOPS™ primary metric and SPC-1 LRT™ metric generated in earlier Test Runs.

There are two identical Repeatability Test Phases. Each Test Phase contains two Test Runs. Each of the Test Runs will have a Measurement Interval of no less than ten (10) minutes. The two Test Runs in each Test Phase will be executed without interruption or any type of manual intervention.

The first Test Run in each Test Phase is executed at the 10% load point. The Average Response Time from each of the Test Runs is compared to the SPC-1 LRT™ metric. Each Average Response Time value must be less than the SPC-1 LRT™ metric plus 5%.

The second Test Run in each Test Phase is executed at the 100% load point. The I/O Request Throughput from the Test Runs is compared to the SPC-1 IOPS™ primary metric. Each I/O Request Throughput value must be greater than the SPC-1 IOPS™ primary metric minus 5%. In addition, the Average Response Time for each Test Run cannot exceed 30 milliseconds.

If any of the above constraints are not met, the benchmark measurement is invalid.

Clause 9.2.4.7.4

The following content shall appear in the FDR for each Test Run in the two Repeatability Test Phases:

- 1. A table containing the results of the Repeatability Test.*
- 2. An I/O Request Throughput Distribution graph and table.*
- 3. An Average Response Time Distribution graph and table.*
- 4. The human readable Test Run Results File produced by the Workload Generator.*
- 5. A listing or screen image of all input parameters supplied to the Workload Generator.*

SPC-1 Workload Generator Input Parameters

The SPC-1 Workload Generator input parameters for the Sustainability, IOPS, Response Time Ramp, Repeatability, and Persistence Test Runs are documented in “Appendix E: SPC-1 Workload Generator Input Parameters” on Page 67.

Repeatability Test Results File

The values for the SPC-1 IOPS™, SPC-1 LRT™, and the Repeatability Test measurements are listed below.

	SPC-1 IOPS™	SPC-1 LRT™
Primary Metrics	24,997.49	4.34
Repeatability Test Phase 1	25,013.23	4.29
Repeatability Test Phase 2	25,000.12	4.28

A link to the test result file generated from each Repeatability Test Run list is listed below.

[Repeatability Test Phase 1, Test Run 1 \(LRT\)](#)

[Repeatability Test Phase 1, Test Run 2 \(IOPS\)](#)

[Repeatability Test Phase 2, Test Run 1 \(LRT\)](#)

[Repeatability Test Phase 2, Test Run 2 \(IOPS\)](#)

Repeatability 1 LRT - I/O Request Throughput Distribution Data

50 BSUs	Start	Stop	Interval	Duration
<i>Start-Up/Ramp-Up</i>	0:12:37	0:15:37	0-2	0:03:00
<i>Measurement Interval</i>	0:15:37	0:25:37	3-12	0:10:00
60 second intervals	All ASUs	ASU1	ASU2	ASU3
0	2,495.80	1,487.65	306.57	701.58
1	2,501.13	1,491.52	305.67	703.95
2	2,501.38	1,490.48	310.12	700.78
3	2,489.32	1,487.93	303.88	697.50
4	2,497.72	1,489.80	305.35	702.57
5	2,502.92	1,493.98	307.25	701.68
6	2,491.93	1,481.50	303.90	706.53
7	2,496.30	1,488.45	309.50	698.35
8	2,500.65	1,493.22	305.27	702.17
9	2,502.60	1,492.38	305.65	704.57
10	2,484.93	1,477.42	307.75	699.77
11	2,496.38	1,482.35	308.07	705.97
12	2,506.75	1,493.08	308.08	705.58
Average	2,496.95	1,488.01	306.47	702.47

Repeatability 1 LRT - I/O Request Throughput Distribution Graph

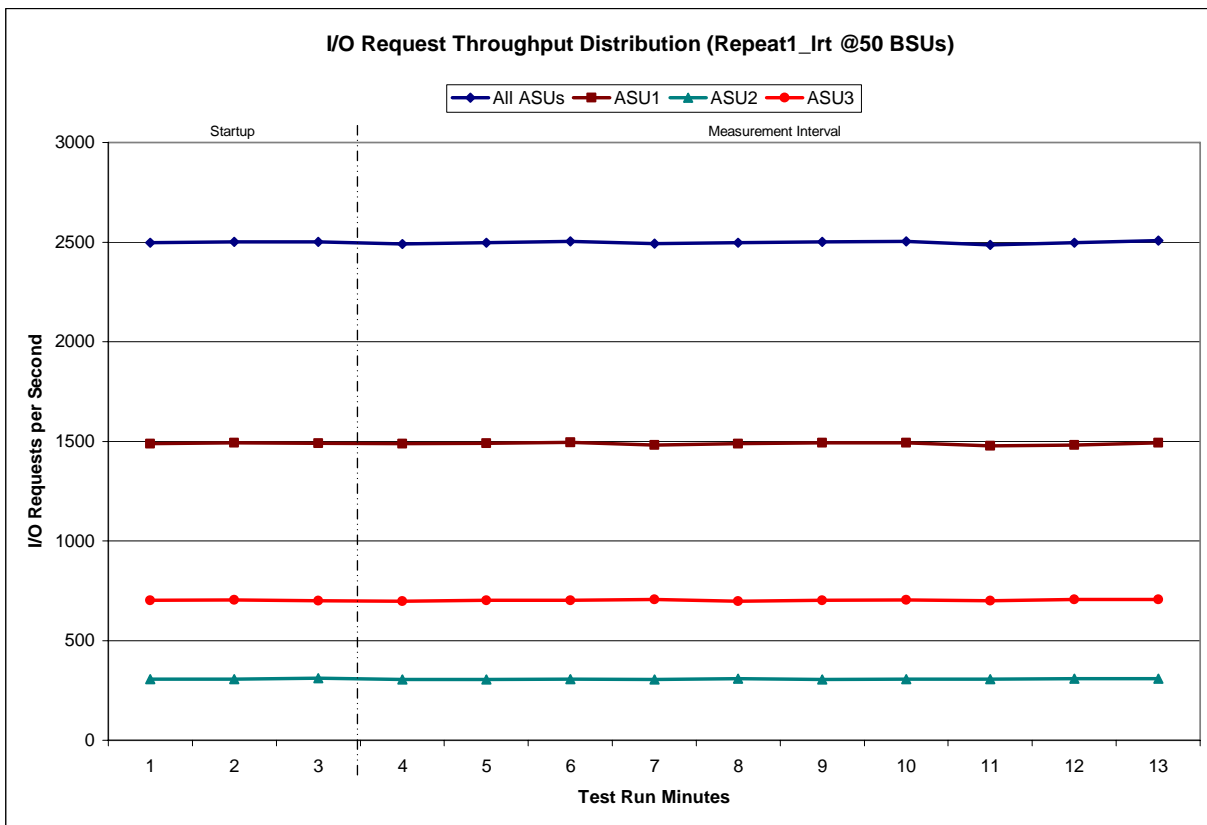

Repeatability 1 LRT –Average Response Time (ms) Distribution Data

50 BSUs	Start	Stop	Interval	Duration
Start-Up/Ramp-Up	0:12:37	0:15:37	0-2	0:03:00
Measurement Interval	0:15:37	0:25:37	3-12	0:10:00
60 second intervals	All ASUs	ASU1	ASU2	ASU3
0	4.37	5.71	6.07	0.78
1	4.29	5.67	5.68	0.78
2	4.29	5.66	5.61	0.79
3	4.31	5.69	5.63	0.80
4	4.27	5.63	5.61	0.80
5	4.30	5.66	5.69	0.80
6	4.31	5.70	5.70	0.80
7	4.31	5.67	5.65	0.80
8	4.28	5.63	5.67	0.79
9	4.29	5.67	5.62	0.81
10	4.29	5.66	5.65	0.79
11	4.27	5.63	5.67	0.79
12	4.27	5.64	5.57	0.80
Average	4.29	5.66	5.65	0.80

Repeatability 1 LRT –Average Response Time (ms) Distribution Graph

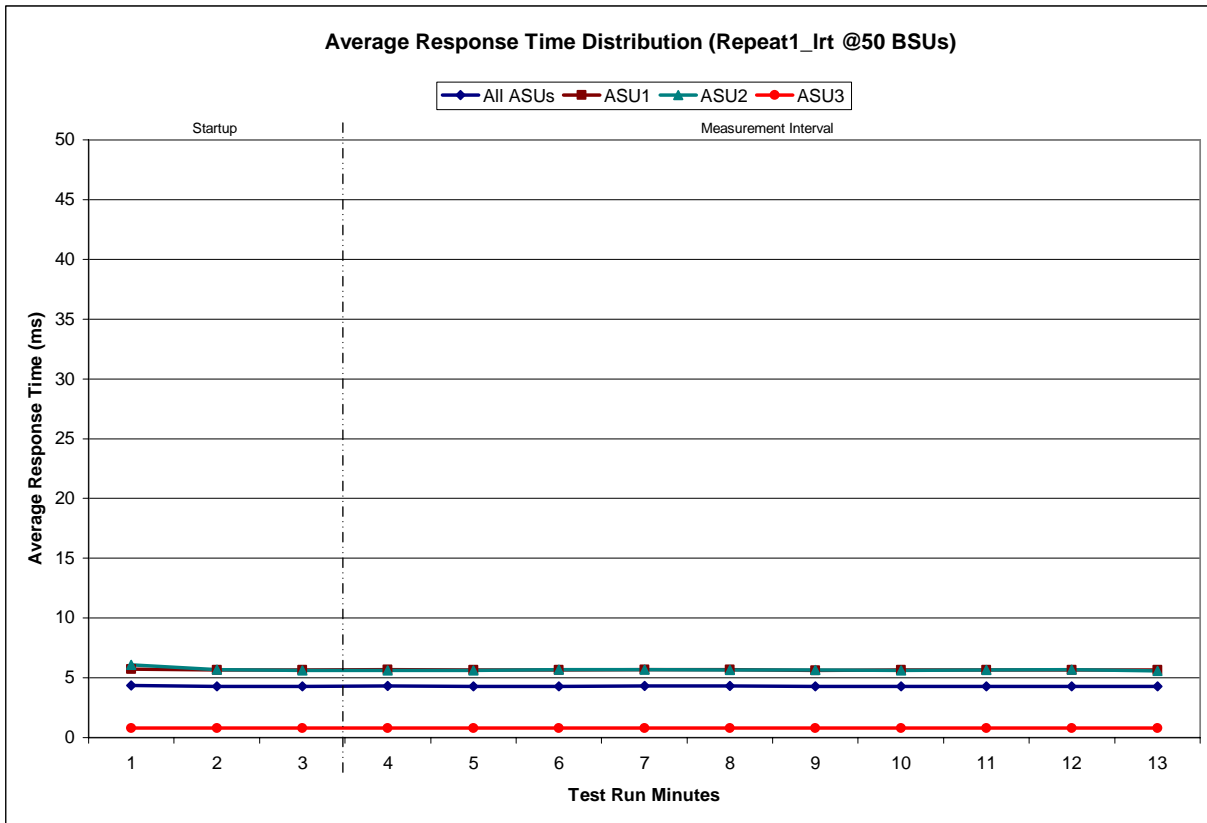

Repeatability 1 IOPS - I/O Request Throughput Distribution Data

500 BSUs	Start	Stop	Interval	Duration
<i>Start-Up/Ramp-Up</i>	0:25:40	0:28:41	0-2	0:03:01
<i>Measurement Interval</i>	0:28:41	0:38:41	3-12	0:10:00
60 second intervals	All ASUs	ASU1	ASU2	ASU3
0	25,005.05	14,892.05	3,073.42	7,039.58
1	24,927.78	14,860.58	3,063.38	7,003.82
2	24,945.42	14,884.33	3,058.50	7,002.58
3	25,046.92	14,926.38	3,090.55	7,029.98
4	24,989.38	14,880.83	3,077.85	7,030.70
5	25,018.52	14,904.68	3,081.30	7,032.53
6	25,024.55	14,918.75	3,079.10	7,026.70
7	24,971.27	14,888.33	3,061.48	7,021.45
8	25,043.65	14,947.13	3,065.05	7,031.47
9	25,019.47	14,901.40	3,077.62	7,040.45
10	24,964.38	14,869.98	3,077.22	7,017.18
11	25,041.53	14,932.00	3,086.45	7,023.08
12	25,012.67	14,904.48	3,080.22	7,027.97
Average	25,013.23	14,907.40	3,077.68	7,028.15

Repeatability 1 IOPS - I/O Request Throughput Distribution Graph

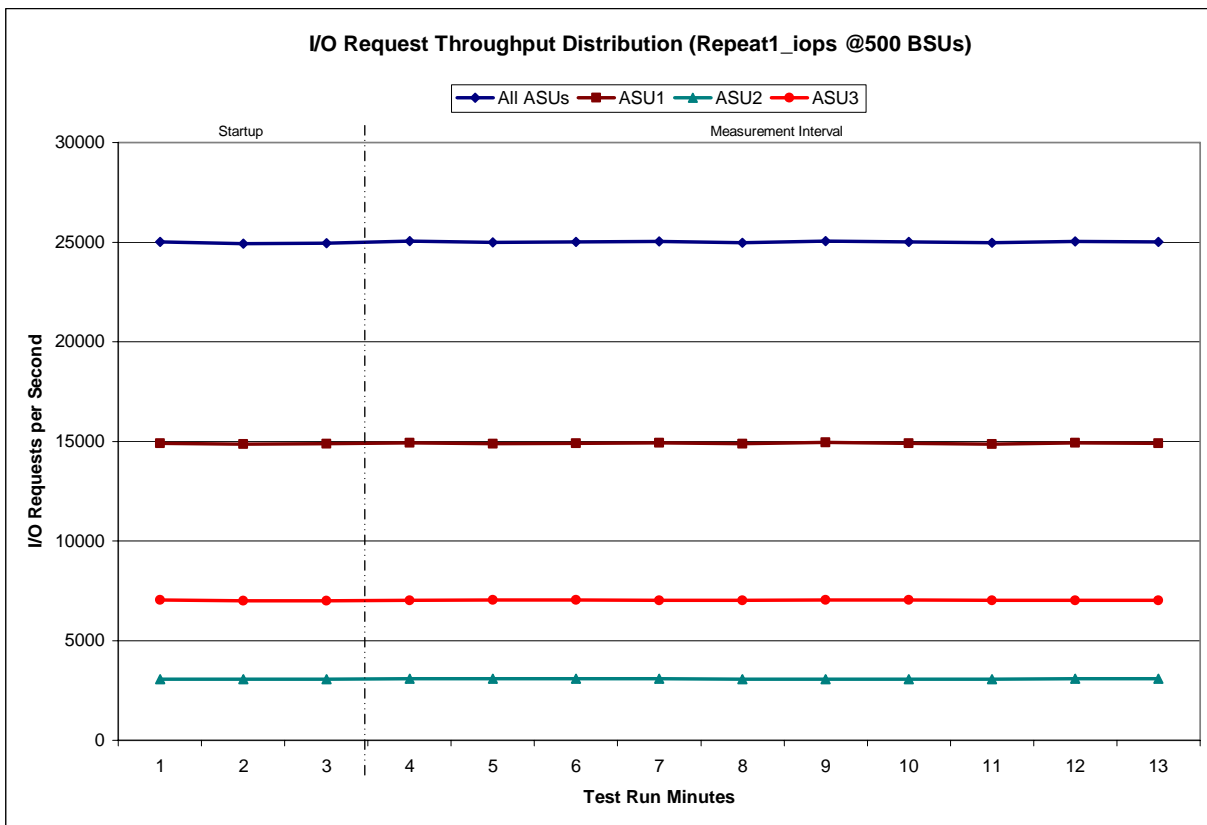

Repeatability 1 IOPS –Average Response Time (ms) Distribution Data

500 BSUs	Start	Stop	Interval	Duration
Start-Up/Ramp-Up	0:25:40	0:28:41	0-2	0:03:01
Measurement Interval	0:28:41	0:38:41	3-12	0:10:00
60 second intervals	All ASUs	ASU1	ASU2	ASU3
0	30.51	39.61	36.73	8.55
1	25.73	32.57	32.59	8.21
2	26.01	33.36	32.17	7.67
3	25.40	32.43	32.07	7.54
4	26.71	33.76	33.04	9.02
5	23.24	29.23	31.71	6.82
6	27.12	34.45	33.42	8.78
7	26.38	33.08	33.53	9.04
8	21.12	26.33	30.82	5.82
9	25.71	32.24	32.99	8.70
10	25.40	32.10	32.32	8.17
11	23.78	30.05	31.77	6.93
12	25.53	31.93	33.15	8.63
Average	25.04	31.56	32.48	7.94

Repeatability 1 IOPS –Average Response Time (ms) Distribution Graph

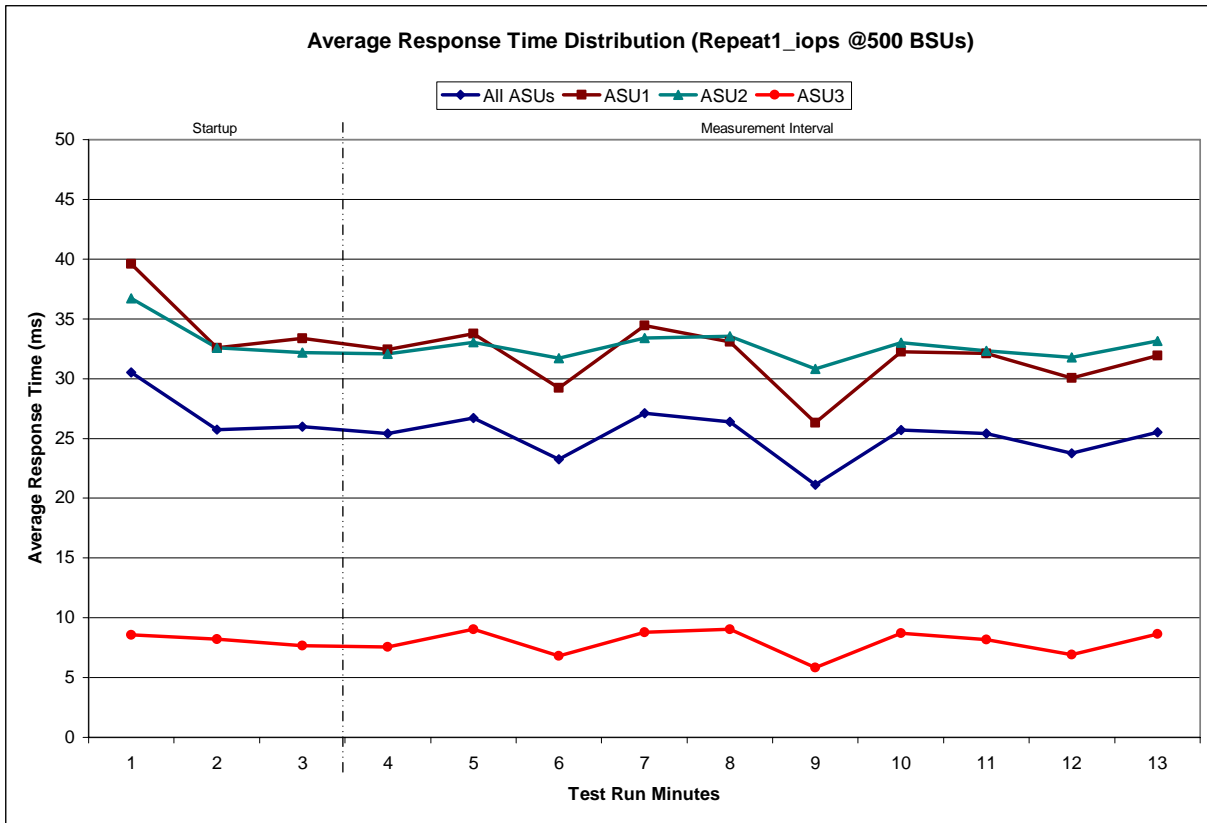

Repeatability 2 LRT - I/O Request Throughput Distribution Data

50 BSUs	Start	Stop	Interval	Duration
Start-Up/Ramp-Up	0:38:46	0:41:46	0-2	0:03:00
Measurement Interval	0:41:46	0:51:46	3-12	0:10:00
60 second intervals	All ASUs	ASU1	ASU2	ASU3
0	2,507.23	1,497.82	310.20	699.22
1	2,496.20	1,487.98	308.05	700.17
2	2,496.20	1,485.35	306.52	704.33
3	2,494.35	1,484.00	306.47	703.88
4	2,490.85	1,487.33	304.40	699.12
5	2,503.00	1,488.67	308.70	705.63
6	2,492.82	1,486.68	307.87	698.27
7	2,490.67	1,486.62	303.13	700.92
8	2,498.10	1,490.80	304.95	702.35
9	2,495.03	1,485.38	305.52	704.13
10	2,494.37	1,488.37	307.18	698.82
11	2,498.63	1,488.95	310.82	698.87
12	2,503.47	1,490.78	308.87	703.82
Average	2,496.13	1,487.76	306.79	701.58

Repeatability 2 LRT - I/O Request Throughput Distribution Graph

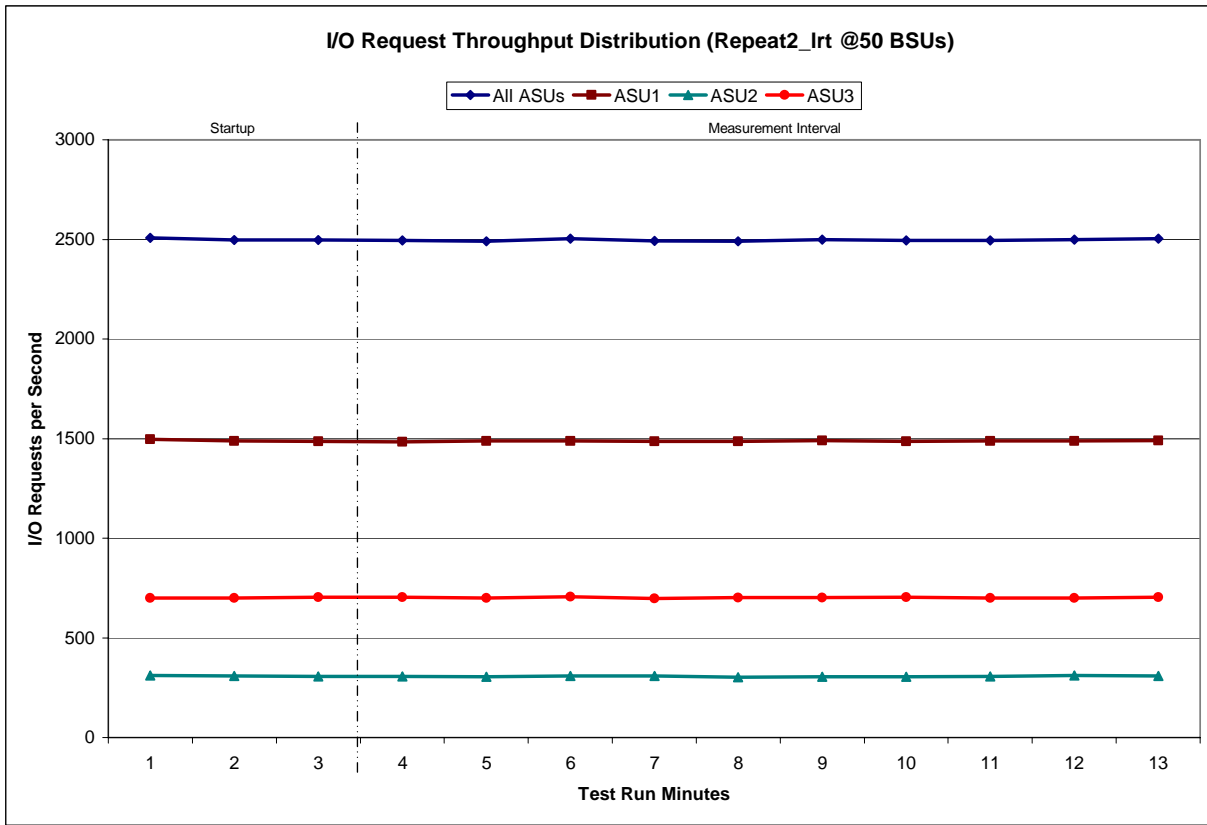

Repeatability 2 LRT –Average Response Time (ms) Distribution Data

50 BSUs	Start	Stop	Interval	Duration
<i>Start-Up/Ramp-Up</i>	0:38:46	0:41:46	0-2	0:03:00
<i>Measurement Interval</i>	0:41:46	0:51:46	3-12	0:10:00
60 second intervals	All ASUs	ASU1	ASU2	ASU3
0	4.38	5.71	6.02	0.80
1	4.34	5.71	5.73	0.82
2	4.27	5.64	5.65	0.79
3	4.28	5.64	5.69	0.81
4	4.26	5.60	5.61	0.81
5	4.30	5.66	5.69	0.81
6	4.30	5.65	5.71	0.81
7	4.29	5.65	5.63	0.82
8	4.25	5.61	5.63	0.78
9	4.27	5.63	5.64	0.80
10	4.30	5.66	5.67	0.79
11	4.29	5.64	5.65	0.79
12	4.28	5.64	5.63	0.82
Average	4.28	5.64	5.65	0.80

Repeatability 2 LRT –Average Response Time (ms) Distribution Graph

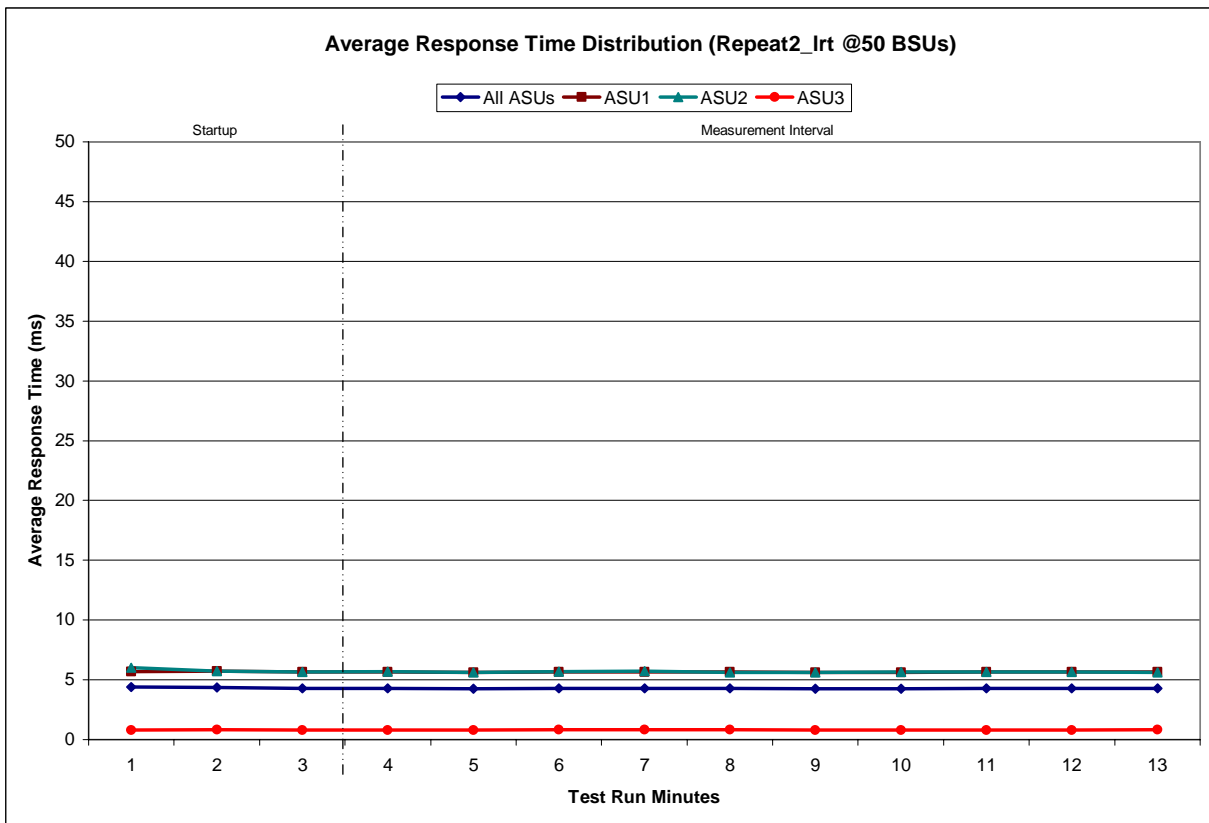

Repeatability 2 IOPS - I/O Request Throughput Distribution Data

500 BSUs	Start	Stop	Interval	Duration
Start-Up/Ramp-Up	0:51:49	0:54:50	0-2	0:03:01
Measurement Interval	0:54:50	1:04:50	3-12	0:10:00
60 second intervals	All ASUs	ASU1	ASU2	ASU3
0	25,004.35	14,898.62	3,079.50	7,026.23
1	24,992.57	14,886.32	3,082.27	7,023.98
2	24,994.95	14,890.42	3,072.53	7,032.00
3	24,805.58	14,787.42	3,047.65	6,970.52
4	25,183.83	15,010.10	3,100.45	7,073.28
5	24,972.10	14,885.55	3,064.67	7,021.88
6	25,060.78	14,945.18	3,071.83	7,043.77
7	24,983.68	14,897.52	3,064.97	7,021.20
8	25,012.85	14,913.82	3,068.65	7,030.38
9	25,020.90	14,897.13	3,074.70	7,049.07
10	24,991.50	14,898.27	3,085.08	7,008.15
11	24,948.37	14,894.78	3,059.75	6,993.83
12	25,021.60	14,903.45	3,092.35	7,025.80
Average	25,000.12	14,903.32	3,073.01	7,023.79

Repeatability 2 IOPS - I/O Request Throughput Distribution Graph

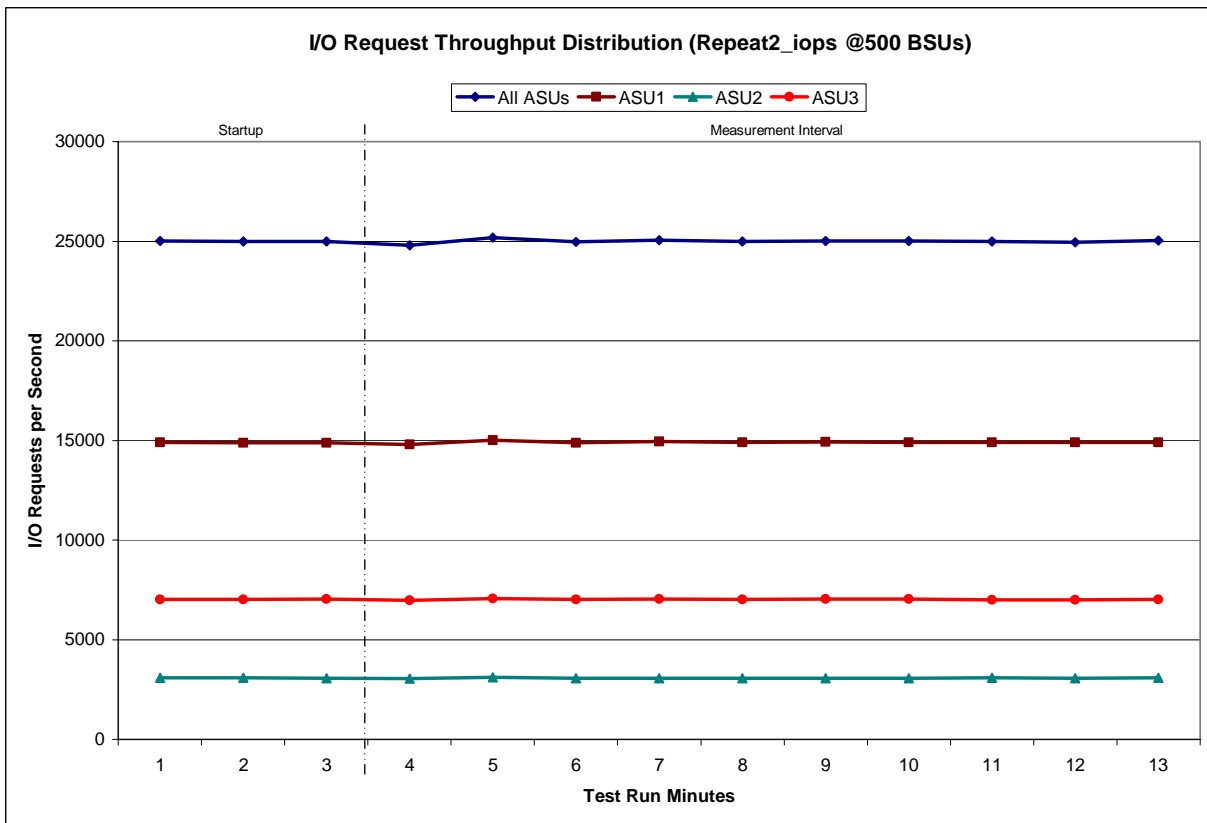

Repeatability 2 IOPS –Average Response Time (ms) Distribution Data

500 BSUs Start-Up/Ramp-Up Measurement Interval	Start	Stop	Interval	Duration
	0:51:49	0:54:50	0-2	0:03:01
	0:54:50	1:04:50	3-12	0:10:00
60 second intervals	All ASUs	ASU1	ASU2	ASU3
0	26.91	33.91	35.71	8.23
1	26.09	32.82	33.21	8.70
2	24.86	31.22	32.53	8.06
3	24.79	30.94	32.80	8.25
4	25.44	32.07	33.18	7.97
5	23.61	29.27	32.22	7.87
6	24.69	30.85	32.84	8.08
7	24.10	30.08	32.37	7.79
8	25.75	32.29	33.12	8.64
9	26.73	33.72	33.57	8.98
10	23.76	29.52	32.22	7.80
11	24.99	31.09	32.61	8.68
12	22.77	28.34	31.45	7.12
Average	24.66	30.82	32.64	8.12

Repeatability 2 IOPS –Average Response Time (ms) Distribution Graph

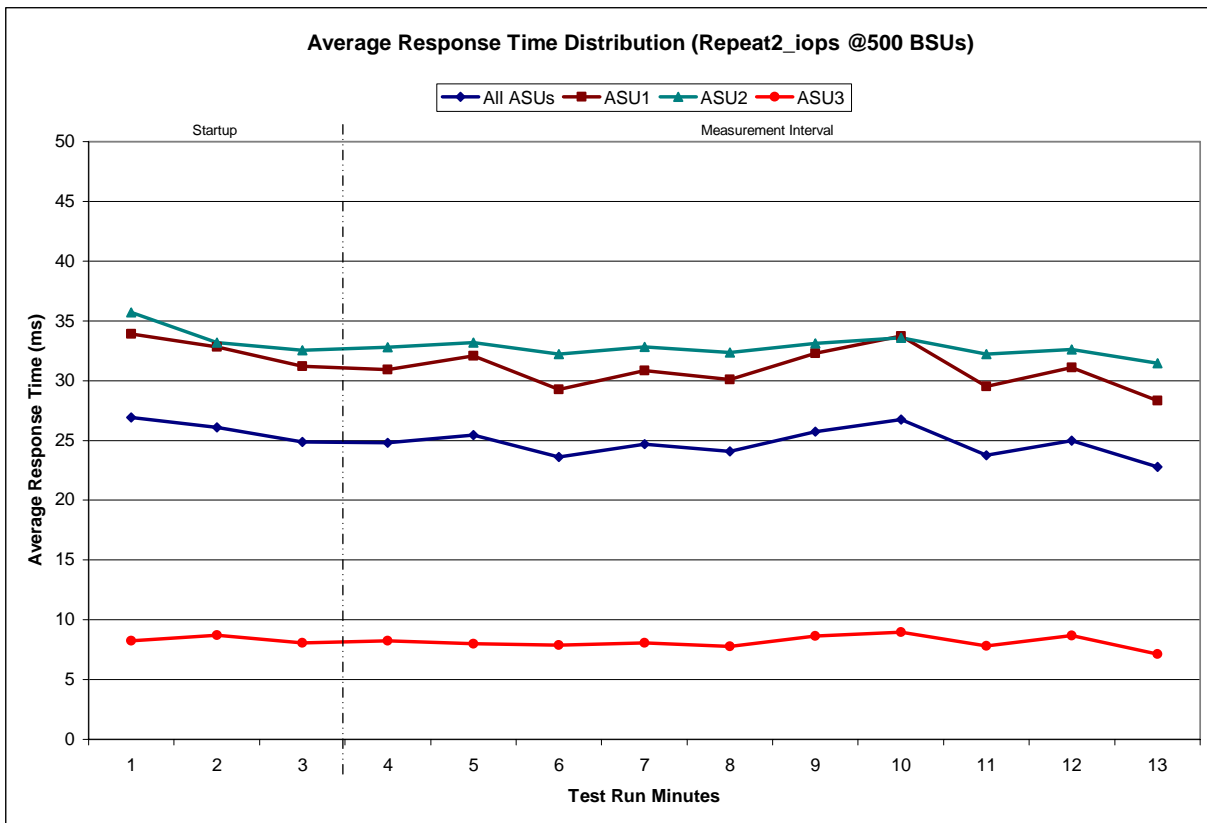

**Repeatability 1 (LRT)
Measured Intensity Multiplier and Coefficient of Variation**

Clause 3.4.3

IM – Intensity Multiplier: The ratio of I/Os for each I/O stream relative to the total I/Os for all I/O streams (ASU1-1 – ASU3-1) as required by the benchmark specification.

Clauses 5.1.0 and 5.3.13.2

MIM – Measured Intensity Multiplier: The Measured Intensity Multiplier represents the ratio of measured I/Os for each I/O stream relative to the total I/Os measured for all I/O streams (ASU1-1 – ASU3-1). This value may differ from the corresponding Expected Intensity Multiplier by no more than 5%.

Clause 5.3.13.3

COV – Coefficient of Variation: This measure of variation for the Measured Intensity Multiplier cannot exceed 0.2.

	ASU1-1	ASU1-2	ASU1-3	ASU1-4	ASU2-1	ASU2-2	ASU2-3	ASU3-1
IM	0.0350	0.2810	0.0700	0.2100	0.0180	0.0700	0.0350	0.2810
MIM	0.0347	0.2814	0.0697	0.2101	0.0180	0.0699	0.0348	0.2813
COV	0.014	0.005	0.007	0.005	0.017	0.008	0.012	0.004

**Repeatability 1 (IOPS)
Measured Intensity Multiplier and Coefficient of Variation**

	ASU1-1	ASU1-2	ASU1-3	ASU1-4	ASU2-1	ASU2-2	ASU2-3	ASU3-1
IM	0.0350	0.2810	0.0700	0.2100	0.0180	0.0700	0.0350	0.2810
MIM	0.0350	0.2811	0.0700	0.2099	0.0180	0.0700	0.0351	0.2810
COV	0.004	0.001	0.004	0.002	0.005	0.003	0.007	0.001

**Repeatability 2 (LRT)
Measured Intensity Multiplier and Coefficient of Variation**

	ASU1-1	ASU1-2	ASU1-3	ASU1-4	ASU2-1	ASU2-2	ASU2-3	ASU3-1
IM	0.0350	0.2810	0.0700	0.2100	0.0180	0.0700	0.0350	0.2810
MIM	0.0348	0.2813	0.0704	0.2095	0.0180	0.0701	0.0349	0.2811
COV	0.013	0.003	0.007	0.005	0.017	0.009	0.009	0.003

Repeatability 2 (IOPS)
Measured Intensity Multiplier and Coefficient of Variation

	ASU1-1	ASU1-2	ASU1-3	ASU1-4	ASU2-1	ASU2-2	ASU2-3	ASU3-1
<i>IM</i>	<i>0.0350</i>	<i>0.2810</i>	<i>0.0700</i>	<i>0.2100</i>	<i>0.0180</i>	<i>0.0700</i>	<i>0.0350</i>	<i>0.2810</i>
MIM	0.0350	0.2810	0.0700	0.2102	0.0180	0.0699	0.0350	0.2810
COV	0.003	0.001	0.002	0.002	0.007	0.003	0.004	0.001

Data Persistence Test

Clause 6

The Data Persistence Test demonstrates the Tested Storage Configuration (TSC):

- *Is capable of maintain data integrity across a power cycle.*
- *Ensures the transfer of data between Logical Volumes and host systems occurs without corruption or loss.*

The SPC-1 Workload Generator will write 16 block I/O requests at random over the total Addressable Storage Capacity of the TSC for ten (10) minutes at a minimum of 25% of the load used to generate the SPC-1 IOP™ primary metric. The bit pattern selected to be written to each block as well as the address of the block will be retained in a log file.

The Benchmark Configuration will be shutdown and restarted using a power off/power on cycle at the end of the above sequence of write operations. In addition, any caches employing battery backup must be flushed/emptied.

The SPC-1 Workload Generator will then use the above log file to verify each block written contains the correct bit pattern.

Clause 9.2.4.8

The following content shall appear in this section of the FDR:

1. *A listing or screen image of all input parameters supplied to the Workload Generator.*
2. *For the successful Data Persistence Test Run, a table illustrating key results. The content, appearance, and format of this table are specified in Table 9-12. Information displayed in this table shall be obtained from the Test Run Results File referenced below in #3.*
3. *For the successful Data Persistence Test Run, the human readable Test Run Results File produced by the Workload Generator.*

SPC-1 Workload Generator Input Parameters

The SPC-1 Workload Generator input parameters for the Sustainability, IOPS, Response Time Ramp, Repeatability, and Persistence Test Runs are documented in “Appendix E: SPC-1 Workload Generator Input Parameters” on Page 67.

Data Persistence Test Results File

A link to each test result file generated from each Data Persistence Test is listed below.

[Persistence 1 Test Results File](#)

[Persistence 2 Test Results File](#)

Data Persistence Test Results

Data Persistence Test Results	
Data Persistence Test Run Number: 1	
Total Number of Logical Blocks Written	38,525,888
Total Number of Logical Blocks Verified	35,818,736
Total Number of Logical Blocks that Failed Verification	0
Time Duration for Writing Test Logical Blocks	10 minutes
Size in Bytes of each Logical Block	512
Number of Failed I/O Requests in the process of the Test	0

In some cases the same address was the target of multiple writes, which resulted in more Logical Blocks Written than Logical Blocks Verified. In the case of multiple writes to the same address, the pattern written and verified must be associated with the last write to that address.

PRICED STORAGE CONFIGURATION AVAILABILITY DATE

Clause 9.2.4.9

The committed delivery data for general availability (Availability Date) of all products that comprise the Priced Storage Configuration must be reported. When the Priced Storage Configuration includes products or components with different availability dates, the reported Availability Date must be the date at which all components are committed to be available.

The FDR shall state: "The Priced Storage Configuration, as documented in this Full Disclosure Report will be available for shipment to customers on MMMM DD, YYYY." Where Priced Storage Configuration is the TSC Configuration Name as described in Clause 9.2.4.3.3 and MMMM is the alphanumeric month, DD is the numeric day, and YYYY is the numeric year of the date that the Priced Storage Configuration, as documented, is available for shipment to customers as described above.

The EMC CLARiiON CX3 Model 40 as documented in this Full Disclosure Report is currently available for customer purchase and shipment.

PRICING INFORMATION

Clause 9.2.4.11

A statement of the respective calculations for pricing must be included.

Clause 9.2.4.11.3

A list of all differences between the Tested Storage Configuration (TSC) and Priced Storage Configuration must be included.

Pricing information may found in the Tested Storage Configuration Pricing section on page 13. A list of all differences between the Tested Storage Configuration (TSC) and Priced Storage Configuration may be found in the Executive Summary portion of this document on page 13.

ANOMALIES OR IRREGULARITIES

Clause 9.2.4.10

The FDR shall include a clear and complete description of any anomalies or irregularities encountered in the course of executing the SPC-1 benchmark that may in any way call into question the accuracy, verifiability, or authenticity of information published in this FDR.

There were no anomalies or irregularities encountered during the SPC-1 Onsite Audit of the EMC CLARiiON CX3 Model 40.

APPENDIX A: SPC-1 GLOSSARY

“Decimal” (*powers of ten*) Measurement Units

In the storage industry, the terms “kilo”, “mega”, “giga”, “tera”, “peta”, and “exa” are commonly used prefixes for computing performance and capacity. For the purposes of the SPC workload definitions, all of the following terms are defined in “powers of ten” measurement units.

- A kilobyte (KB) is equal to 1,000 (10^3) bytes.
- A megabyte (MB) is equal to 1,000,000 (10^6) bytes.
- A gigabyte (GB) is equal to 1,000,000,000 (10^9) bytes.
- A terabyte (TB) is equal to 1,000,000,000,000 (10^{12}) bytes.
- A petabyte (PB) is equal to 1,000,000,000,000,000 (10^{15}) bytes
- An exabyte (EB) is equal to 1,000,000,000,000,000,000 (10^{18}) bytes

“Binary” (*powers of two*) Measurement Units

The sizes reported by many operating system components use “powers of two” measurement units rather than “power of ten” units. The following standardized definitions and terms are also valid and may be used in this document.

- A kibibyte (KiB) is equal to 1,024 (2^{10}) bytes.
- A mebibyte (MiB) is equal to 1,048,576 (2^{20}) bytes.
- A gibibyte (GiB) is equal to 1,073,741,824 (2^{30}) bytes.
- A tebibyte (TiB) is equal to 1,099,511,627,776 (2^{40}) bytes.
- A pebibyte (PiB) is equal to 1,125,899,906,842,624 (2^{50}) bytes.
- An exbibyte (EiB) is equal to 1,152,921,504,606,846,967 (2^{60}) bytes.

SPC-1 Data Repository Definitions

Total ASU Capacity: The total storage capacity read and written in the course of executing the SPC-1 benchmark.

Application Storage Unit (ASU): The logical interface between the storage and SPC-1 Workload Generator. The three ASUs (Data, User, and Log) are typically implemented on one or more Logical Volume.

Logical Volume: The division of Addressable Storage Capacity into individually addressable logical units of storage used in the SPC-1 benchmark. Each Logical Volume is implemented as a single, contiguous address space.

Addressable Storage Capacity: The total storage (sum of Logical Volumes) that can be read and written by application programs such as the SPC-1 Workload Generator.

Configured Storage Capacity: This capacity includes the Addressable Storage Capacity and any other storage (parity disks, hot spares, etc.) necessary to implement the Addressable Storage Capacity.

Physical Storage Capacity: The formatted capacity of all storage devices physically present in the Tested Storage Configuration (TSC).

Data Protection Overhead: The storage capacity required to implement the selected level of data protection.

Required Storage: The amount of Configured Storage Capacity required to implement the Addressable Storage Configuration, excluding the storage required for the three ASUs.

Global Storage Overhead: The amount of Physical Storage Capacity that is required for storage subsystem use and unavailable for use by application programs.

Total Unused Storage: The amount of storage capacity available for use by application programs but not included in the Total ASU Capacity.

SPC-1 Data Protection Levels

RAID5: User data is distributed across the disks in the array. Check data corresponding to user data is distributed across multiple disks in the form of bit-by-bit parity.

Mirroring: Two or more identical copies of user data are maintained on separate disks.

Other Protection Level: Any data protection other than **RAID5** or **Mirroring**.

Unprotected: There is no data protection provided.

SPC-1 Test Execution Definitions

Average Response Time: The sum of the Response Times for all Measured I/O Requests divided by the total number of Measured I/O Requests.

Completed I/O Request: An I/O Request with a Start Time and a Completion Time (see "I/O Completion Types" below).

Completion Time: The time recorded by the Workload Generator when an I/O Request is satisfied by the TSC as signaled by System Software.

Data Rate: The data transferred in all Measured I/O Requests in an SPC-1 Test Run divided by the length of the Test Run in seconds.

Expected I/O Count: For any given I/O Stream and Test Phase, the product of 50 times the BSU level, the duration of the Test Phase in seconds, and the Intensity Multiplier for that I/O Stream.

Failed I/O Request: Any I/O Request issued by the Workload Generator that could not be completed or was signaled as failed by System Software. A Failed I/O Request has no Completion Time (see “I/O Completion Types” below).

I/O Request Throughput: The total number of Measured I/O requests in an SPC-1 Test Run divided by the duration of the Measurement Interval in seconds.

In-Flight I/O Request: An I/O Request issued by the I/O Command Generator to the TSC that has a recorded Start Time, but does not complete within the Measurement Interval (see “I/O Completion Types” below).

Measured I/O Request: A Completed I/O Request with a Completion Time occurring within the Measurement Interval (see “I/O Completion Types” below).

Measured Intensity Multiplier: The percentage of all Measured I/O Requests that were issued by a given I/O Stream.

Measurement Interval: The finite and contiguous time period, after the TSC has reached Steady State, when data is collected by a Test Sponsor to generate an SPC-1 test result or support an SPC-1 test result.

Ramp-Up: The time required for the Benchmark Configuration (BC) to produce Steady State throughput after the Workload Generator begins submitting I/O Requests to the TSC for execution.

Ramp-Down: The time required for the BC to complete all I/O Requests issued by the Workload Generator. The Ramp-Down period begins when the Workload Generator ceases to issue new I/O Requests to the TSC.

Response Time: The Response Time of a Measured I/O Request is its Completion Time minus its Start Time.

Start Time: The time recorded by the Workload Generator when an I/O Request is submitted, by the Workload Generator, to the System Software for execution on the Tested Storage Configuration (TSC).

Start-Up: The period that begins after the Workload Generator starts to submit I/O requests to the TSC and ends at the beginning of the Measurement Interval.

Shut-Down: The period between the end of the Measurement Interval and the time when all I/O Requests issued by the Workload Generator have completed or failed.

Steady State: The consistent and sustainable throughput of the TSC. During this period the load presented to the TSC by the Workload Generator is constant.

Test: A collection of Test Phases and or Test Runs sharing a common objective.

Test Run: The execution of SPC-1 for the purpose of producing or supporting an SPC-1 test result. SPC-1 Test Runs may have a finite and measured Ramp-Up period, Start-Up

period, Shut-Down period, and Ramp-Down period as illustrated in the “SPC-1 Test Run Components” below. All SPC-1 Test Runs shall have a Steady State period and a Measurement Interval.

Test Phase: A collection of one or more SPC-1 Test Runs sharing a common objective and intended to be run in a specific sequence.

I/O Completion Types

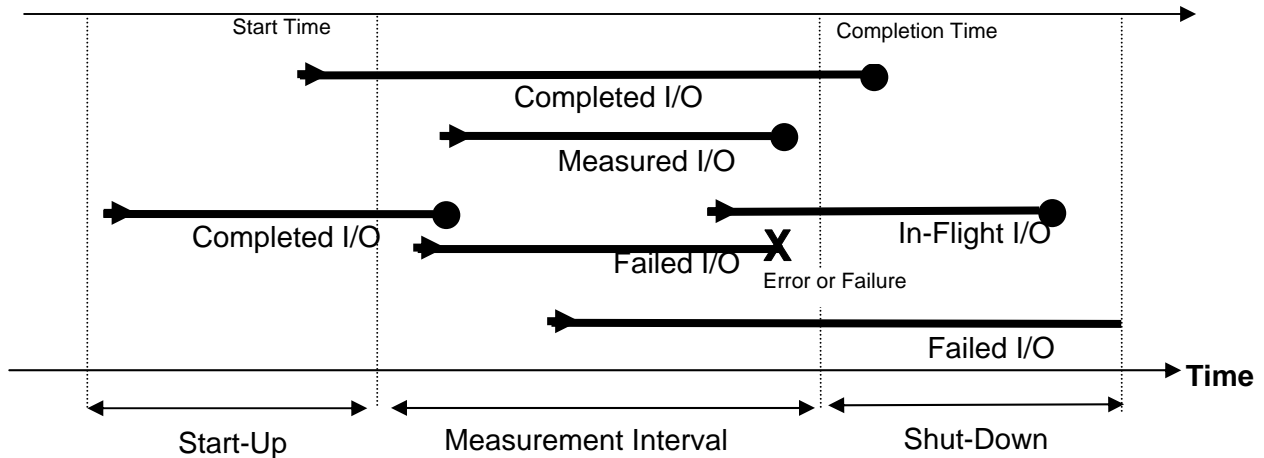

SPC-1 Test Run Components

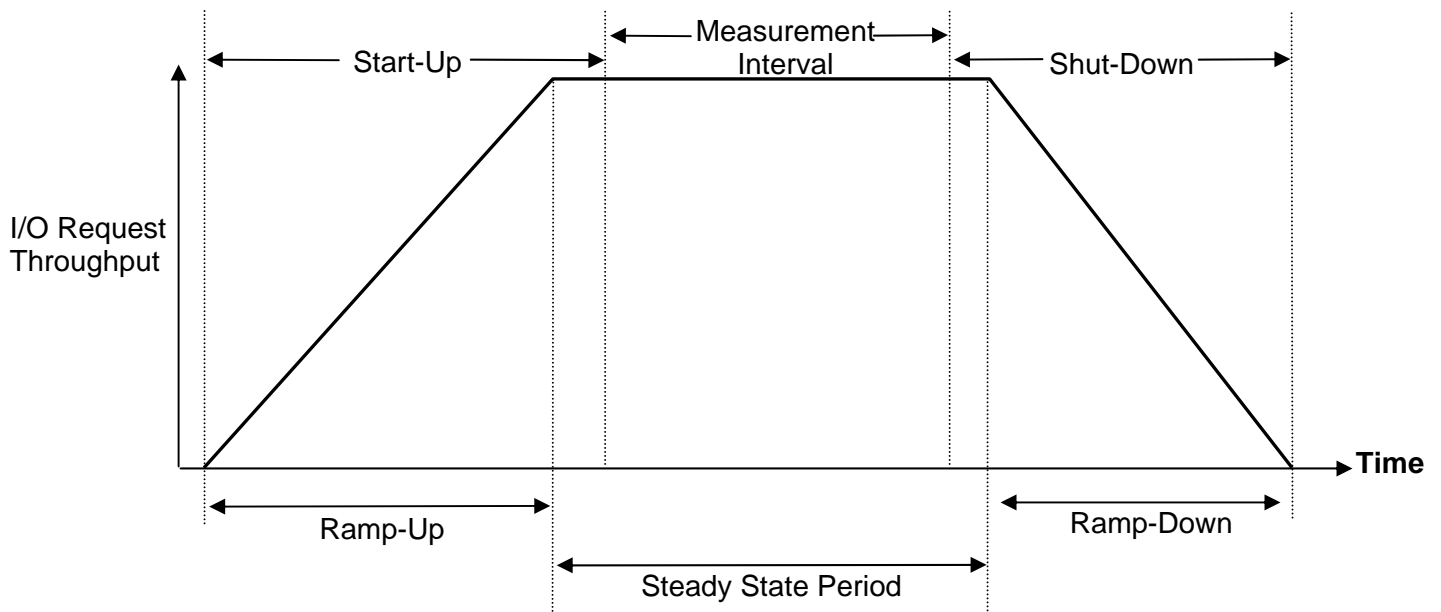

APPENDIX B: CUSTOMER TUNABLE PARAMETERS AND OPTIONS

Windows 2003 Server

For each HBA in the system, change the execution throttle (queue depth) from the default value of 16 to 256.

CX3-40 Storage System

The following changes must be made on the CX3-40 storage system:

- Disable write caching on all underlying LUNs used for ASU1 and ASU2. Do not change the default setting of read/write caching for the ASU3 LUNs.
- Set the read policy: low water mark is 30%, high water mark is 50%.
- Set the read caches to 1716 and the write cache to 1300 MB.

APPENDIX C: TESTED STORAGE CONFIGURATION (TSC) CREATION

Storage System

The following sections document how to set up the storage processors and create the RAID groups and LUNs that comprise the SPC-1 data repository.

Create RAID Groups

Run the following script to create the RAID groups:

```
naviseccli -User admin -Password password -Scope 0 -h 10.61.162.55 createrg 0 0_1_0
1_3_0 0_1_1 1_3_1 0_1_2 1_3_2 0_1_3 1_3_3 0_1_4 1_3_4 0_1_5 1_3_5
naviseccli -User admin -Password password -Scope 0 -h 10.61.162.55 createrg 1 0_1_6
1_3_6 0_1_7 1_3_7 0_1_8 1_3_8 0_1_9 1_3_9 0_1_10 1_3_10 0_1_11 1_3_11
naviseccli -User admin -Password password -Scope 0 -h 10.61.162.55 createrg 2 0_2_0
1_4_0 0_2_1 1_4_1 0_2_2 1_4_2 0_2_3 1_4_3 0_2_4 1_4_4 0_2_5 1_4_5
naviseccli -User admin -Password password -Scope 0 -h 10.61.162.55 createrg 3 0_2_6
1_4_6 0_2_7 1_4_7 0_2_8 1_4_8 0_2_9 1_4_9 0_2_10 1_4_10 0_2_11 1_4_11
naviseccli -User admin -Password password -Scope 0 -h 10.61.162.55 createrg 4 0_3_0
1_5_0 0_3_1 1_5_1 0_3_2 1_5_2 0_3_3 1_5_3 0_3_4 1_5_4 0_3_5 1_5_5
naviseccli -User admin -Password password -Scope 0 -h 10.61.162.55 createrg 5 0_3_6
1_5_6 0_3_7 1_5_7 0_3_8 1_5_8 0_3_9 1_5_9 0_3_10 1_5_10 0_3_11 1_5_11
naviseccli -User admin -Password password -Scope 0 -h 10.61.162.55 createrg 6 0_4_0
1_6_0 0_4_1 1_6_1 0_4_2 1_6_2 0_4_3 1_6_3 0_4_4 1_6_4 0_4_5 1_6_5
naviseccli -User admin -Password password -Scope 0 -h 10.61.162.55 createrg 7 0_4_6
1_6_6 0_4_7 1_6_7 0_4_8 1_6_8 0_4_9 1_6_9 0_4_10 1_6_10 0_4_11 1_6_11
naviseccli -User admin -Password password -Scope 0 -h 10.61.162.55 createrg 8 0_5_0
1_7_0 0_5_1 1_7_1 0_5_2 1_7_2 0_5_3 1_7_3 0_5_4 1_7_4 0_5_5 1_7_5
naviseccli -User admin -Password password -Scope 0 -h 10.61.162.55 createrg 9 0_5_6
1_7_6 0_5_7 1_7_7 0_5_8 1_7_8 0_5_9 1_7_9 0_5_10 1_7_10 0_5_11 1_7_11
naviseccli -User admin -Password password -Scope 0 -h 10.61.162.55 createrg 10
0_1_12 1_3_12 0_1_13 1_3_13 0_2_12 1_4_12 0_2_13 1_4_13 0_3_12 1_5_12 0_3_13 1_5_13
naviseccli -User admin -Password password -Scope 0 -h 10.61.162.55 createrg 11
0_4_12 1_6_12 0_4_13 1_6_13 0_5_12 1_7_12 0_5_13 1_7_13 0_1_14 1_3_14 0_2_14 1_4_14
```

Create LUNs

Run the following script to create the LUNs:

```
naviseccli -User admin -Password password -Scope 0 -h 10.61.162.55 bind r1_0 0 -rg 0
-cap 296 -sp a
naviseccli -User admin -Password password -Scope 0 -h 10.61.162.55 bind r1_0 1 -rg 0
-cap 296 -sp a
naviseccli -User admin -Password password -Scope 0 -h 10.61.162.55 bind r1_0 2 -rg 0
-cap 65 -sp a
naviseccli -User admin -Password password -Scope 0 -h 10.61.162.55 bind r1_0 3 -rg 1
-cap 296 -sp a
```

```
naviseccli -User admin -Password password -Scope 0 -h 10.61.162.55 bind r1_0 4 -rg 1
-cap 296 -sp a
naviseccli -User admin -Password password -Scope 0 -h 10.61.162.55 bind r1_0 5 -rg 1
-cap 65 -sp a
naviseccli -User admin -Password password -Scope 0 -h 10.61.162.55 bind r1_0 6 -rg 2
-cap 296 -sp a
naviseccli -User admin -Password password -Scope 0 -h 10.61.162.55 bind r1_0 7 -rg 2
-cap 296 -sp a
naviseccli -User admin -Password password -Scope 0 -h 10.61.162.55 bind r1_0 8 -rg 2
-cap 65 -sp a
naviseccli -User admin -Password password -Scope 0 -h 10.61.162.55 bind r1_0 9 -rg 3
-cap 296 -sp a
naviseccli -User admin -Password password -Scope 0 -h 10.61.162.55 bind r1_0 10 -rg
3 -cap 296 -sp a
naviseccli -User admin -Password password -Scope 0 -h 10.61.162.55 bind r1_0 11 -rg
3 -cap 65 -sp a
naviseccli -User admin -Password password -Scope 0 -h 10.61.162.55 bind r1_0 12 -rg
4 -cap 296 -sp a
naviseccli -User admin -Password password -Scope 0 -h 10.61.162.55 bind r1_0 13 -rg
4 -cap 296 -sp a
naviseccli -User admin -Password password -Scope 0 -h 10.61.162.55 bind r1_0 14 -rg
4 -cap 65 -sp a
naviseccli -User admin -Password password -Scope 0 -h 10.61.162.55 bind r1_0 15 -rg
5 -cap 296 -sp a
naviseccli -User admin -Password password -Scope 0 -h 10.61.162.55 bind r1_0 16 -rg
5 -cap 296 -sp a
naviseccli -User admin -Password password -Scope 0 -h 10.61.162.55 bind r1_0 17 -rg
5 -cap 65 -sp a
naviseccli -User admin -Password password -Scope 0 -h 10.61.162.55 bind r1_0 18 -rg
6 -cap 296 -sp b
naviseccli -User admin -Password password -Scope 0 -h 10.61.162.55 bind r1_0 19 -rg
6 -cap 296 -sp b
naviseccli -User admin -Password password -Scope 0 -h 10.61.162.55 bind r1_0 20 -rg
6 -cap 65 -sp b
naviseccli -User admin -Password password -Scope 0 -h 10.61.162.55 bind r1_0 21 -rg
7 -cap 296 -sp b
naviseccli -User admin -Password password -Scope 0 -h 10.61.162.55 bind r1_0 22 -rg
7 -cap 296 -sp b
naviseccli -User admin -Password password -Scope 0 -h 10.61.162.55 bind r1_0 23 -rg
7 -cap 65 -sp b
naviseccli -User admin -Password password -Scope 0 -h 10.61.162.55 bind r1_0 24 -rg
8 -cap 296 -sp b
naviseccli -User admin -Password password -Scope 0 -h 10.61.162.55 bind r1_0 25 -rg
8 -cap 296 -sp b
naviseccli -User admin -Password password -Scope 0 -h 10.61.162.55 bind r1_0 26 -rg
8 -cap 65 -sp b
naviseccli -User admin -Password password -Scope 0 -h 10.61.162.55 bind r1_0 27 -rg
9 -cap 296 -sp b
```

```
naviseccli -User admin -Password password -Scope 0 -h 10.61.162.55 bind r1_0 28 -rg
9 -cap 296 -sp b
naviseccli -User admin -Password password -Scope 0 -h 10.61.162.55 bind r1_0 29 -rg
9 -cap 65 -sp b
naviseccli -User admin -Password password -Scope 0 -h 10.61.162.55 bind r1_0 30 -rg
10 -cap 296 -sp b
naviseccli -User admin -Password password -Scope 0 -h 10.61.162.55 bind r1_0 31 -rg
10 -cap 296 -sp b
naviseccli -User admin -Password password -Scope 0 -h 10.61.162.55 bind r1_0 32 -rg
10 -cap 65 -sp b
naviseccli -User admin -Password password -Scope 0 -h 10.61.162.55 bind r1_0 33 -rg
11 -cap 296 -sp b
naviseccli -User admin -Password password -Scope 0 -h 10.61.162.55 bind r1_0 34 -rg
11 -cap 296 -sp b
naviseccli -User admin -Password password -Scope 0 -h 10.61.162.55 bind r1_0 35 -rg
11 -cap 65 -sp b
```

Change LUN Parameters

Run the following script to change the LUN parameters:

```
naviseccli -User admin -Password password -Scope 0 -h 10.61.162.55 chglun -l 0 -c
read
naviseccli -User admin -Password password -Scope 0 -h 10.61.162.55 chglun -l 1 -c
read
naviseccli -User admin -Password password -Scope 0 -h 10.61.162.55 chglun -l 2 -c
rw
naviseccli -User admin -Password password -Scope 0 -h 10.61.162.55 chglun -l 3 -c
read
naviseccli -User admin -Password password -Scope 0 -h 10.61.162.55 chglun -l 4 -c
read
naviseccli -User admin -Password password -Scope 0 -h 10.61.162.55 chglun -l 5 -c
rw
naviseccli -User admin -Password password -Scope 0 -h 10.61.162.55 chglun -l 6 -c
read
naviseccli -User admin -Password password -Scope 0 -h 10.61.162.55 chglun -l 7 -c
read
naviseccli -User admin -Password password -Scope 0 -h 10.61.162.55 chglun -l 8 -c
rw
naviseccli -User admin -Password password -Scope 0 -h 10.61.162.55 chglun -l 9 -c
read
naviseccli -User admin -Password password -Scope 0 -h 10.61.162.55 chglun -l 10 -c
read
naviseccli -User admin -Password password -Scope 0 -h 10.61.162.55 chglun -l 11 -c
rw
naviseccli -User admin -Password password -Scope 0 -h 10.61.162.55 chglun -l 12 -c
read
naviseccli -User admin -Password password -Scope 0 -h 10.61.162.55 chglun -l 13 -c
read
```

```
naviseccli -User admin -Password password -Scope 0 -h 10.61.162.55 chglun -l 14 -c
rw
naviseccli -User admin -Password password -Scope 0 -h 10.61.162.55 chglun -l 15 -c
read
naviseccli -User admin -Password password -Scope 0 -h 10.61.162.55 chglun -l 16 -c
read
naviseccli -User admin -Password password -Scope 0 -h 10.61.162.55 chglun -l 17 -c
rw
naviseccli -User admin -Password password -Scope 0 -h 10.61.162.55 chglun -l 18 -c
read
naviseccli -User admin -Password password -Scope 0 -h 10.61.162.55 chglun -l 19 -c
read
naviseccli -User admin -Password password -Scope 0 -h 10.61.162.55 chglun -l 20 -c
rw
naviseccli -User admin -Password password -Scope 0 -h 10.61.162.55 chglun -l 21 -c
read
naviseccli -User admin -Password password -Scope 0 -h 10.61.162.55 chglun -l 22 -c
read
naviseccli -User admin -Password password -Scope 0 -h 10.61.162.55 chglun -l 23 -c
rw
naviseccli -User admin -Password password -Scope 0 -h 10.61.162.55 chglun -l 24 -c
read
naviseccli -User admin -Password password -Scope 0 -h 10.61.162.55 chglun -l 25 -c
read
naviseccli -User admin -Password password -Scope 0 -h 10.61.162.55 chglun -l 26 -c
rw
naviseccli -User admin -Password password -Scope 0 -h 10.61.162.55 chglun -l 27 -c
read
naviseccli -User admin -Password password -Scope 0 -h 10.61.162.55 chglun -l 28 -c
read
naviseccli -User admin -Password password -Scope 0 -h 10.61.162.55 chglun -l 29 -c
rw
naviseccli -User admin -Password password -Scope 0 -h 10.61.162.55 chglun -l 30 -c
read
naviseccli -User admin -Password password -Scope 0 -h 10.61.162.55 chglun -l 31 -c
read
naviseccli -User admin -Password password -Scope 0 -h 10.61.162.55 chglun -l 32 -c
rw
naviseccli -User admin -Password password -Scope 0 -h 10.61.162.55 chglun -l 33 -c
read
naviseccli -User admin -Password password -Scope 0 -h 10.61.162.55 chglun -l 34 -c
read
naviseccli -User admin -Password password -Scope 0 -h 10.61.162.55 chglun -l 35 -c
rw
```

From the Navisphere GUI, change the following caching parameters after running the above scripts:

- Set the read policy: low water mark is 30%, high water mark is 50%.
- Set the read caches to 1716 and the write cache to 1300 MB.

Host System

The steps required to configure the Host System are listed below:

- Install Microsoft Windows Server 2003 Service Pack 2.
- Install and setup two Qlogic 2462 HBAs.
- Install Qlogic SANsurfer HBA management software.
- Install the Navisphere command line utility and GUI interface.
- Install EMC PowerPath (version 5.0.0.94) for Windows 2003 for load balancing.
- Set the “Execution Throttle” (also known as HBA queue depth) setting on each FCP port from default of 16 to 256 using the SANsurfer HBA management software.
- The steps that follow are required to define the Windows partitions, volumes, and stripe sets used by the SPC-1 benchmark.
 1. Using Navisphere, create a storage group. Add LUNs 0, 3, 6, 9, 12, 15, 18, 21, 24, 27, 30, 33 to the storage group.
 2. Using the Windows disk manager, rescan the disks. 12 new disks will show up.
 3. Use diskpar.exe to create an aligned partition on each new disk: (user input is in **bold**). Note that the 8MB “aligned” partitions created in the following procedure were created to ensure that the remaining space on each of the 36 disks would be properly aligned on a 4K boundary under Windows. These partitions remained unformatted and were not used during the benchmark

```
C:\>diskpar -s 1
Set partition can only be done on a raw drive.
You can use Disk Manager to delete all existing partitions
Are you sure drive 1 is a raw device without any partition? (Y/N) Y

---- Drive 1 Geometry Information ----
Cylinders = 38640
TracksPerCylinder = 255
SectorsPerTrack = 63
BytesPerSector = 512
DiskSize = 317824819200 (Bytes) = 303101 (MB)

We are going to set the new disk partition.
All data on this drive will be lost. continue (Y/N)? Y

Please specify starting offset (in sectors): 64
Please specify partition length (in MB) (Max = 102398): 8
```



```
Done setting partition.  
---- New Partition information ----  
StartingOffset = 32768  
PartitionLength = 8388608  
HiddenSectors = 64  
PartitionNumber = 1  
PartitionType = 7
```

You now should use Disk Manager to format this partition

```
C:\> diskpar -s 2  
.....and so on for each disk.
```

4. Start Windows Disk Manager.
5. Convert the 12 disks to Dynamic Disks.
6. Create a striped volume across the large remaining space on the 12 disks. This will be drive letter "F:". Do not format "F:". Drive F: will be ASU1.
7. Using Navisphere, add LUNs 1, 4, 7, 10, 13, 16, 19, 22, 25, 28, 31, 34 to the existing storage group.
8. Repeat steps 2 through 6 to create drive H. "H" will be used for ASU2.
9. Using Navisphere add LUNs 2, 5, 8, 11, 14, 17, 20, 23, 26, 32, 35 to the existing storage group.
10. Repeat steps 2 through 6 to create drive J. "J" will be used for ASU3.

Brocade FCP Switches

Connect the physical connections from the Host System to the CX3-40 as illustrated on page 14 (*Benchmark Configuration/Tested Storage Configuration Diagram*).

APPENDIX D: SPC-1 WORKLOAD GENERATOR STORAGE COMMANDS AND PARAMETERS

The content of SPC-1 Workload Generator command and parameter file, used in this benchmark, is listed below.

```
javaparms="-Xmx512m"  
sd=asu1_1,lun=\\.\\F:  
sd=asu2_1,lun=\\.\\H:  
sd=asu3_1,lun=\\.\\J:
```

APPENDIX E: SPC-1 WORKLOAD GENERATOR INPUT PARAMETERS

Primary Metrics Test, Repeatability Test, and Persistence Test Run 1

The following script was used to execute the Primary Metrics Test (*Sustainability Test Phase, IOPS Test Phase, and Response Time Ramp Test Phase*), Repeatability Test (*Repeatability Test Phase 1 and Repeatability Test Phase 2*), and Persistence Test Run 1 in an uninterrupted sequence.

```
java -Xmx512m metrics -b 500
java -Xmx512m repeat1 -b 500
java -Xmx512m repeat2 -b 500
java -Xmx512m persist1 -b 500
```

Persistence Test Run 2

The following CLI command was used to execute Persistence Test Run 2:

```
java -Xmx512m persist2
```

APPENDIX F: THIRD-PARTY QUOTE

Listed below is a third-party quote for the priced storage configuration with the exception of the Brocade switches, which were supplied by Network Appliance, Inc.



Alta Technologies, Inc
3850 Annapolis Lane, Suite 100
Plymouth, MN 55447

Phone: 800-546-2582 x327
Direct dial: 763-475-5327
Fax number: 763-475-0409

QUOTE FOR: Network Appliance
7301 Kit Creek Road, Building 1
Research Triangle Park, NC 27709
Office: 919.476.5700

1/4/2007

Quantity	Description		Unit list			
			price	Disc	Total	
1	1	CX3-40C-FD - SPE-FIELD INSTALL	EA	42,300	0%	42,300
2	11	CX-4PDAE-FD - 4G DAE FIELD INSTALL	EA	5,900	0%	64,900
3	150	CX-4G15-146 - 146GB 15K 4GB FC	EA	1,645	0%	246,750
4	1	V-CX4014615K - VAULT PACK CX3-40 148GB 15K 4GB DRIVES QTY 5	EA	8,225	0%	8,225
5	4	FC2-HSSDC-8M - 8M HSSDC2 to HSSDC2 bus cbl	EA	600	0%	2,400
6	1	PP-WN-KIT - POWERPATH WINDOWS KIT	EA	0	0%	0
7	1	NAV-ENKIT - NAVI ENTERPRISE MEDIA	EA	0	0%	0
8	8	NAVAGT-WINKIT - NAVI AGENT WINDOWS MEDIA	EA	0	0%	0
10	8	UTIL-WIN - Windows Software Utilities	EA		0%	320
11	1	CX34C-KIT - CS3-40C DOCS AND RTU KIT	EA	0	0%	0
12	1	C-MODEM-US - CLARIIION SERVICE MODEM-US	EA	0	0%	0
13	1	NAV34-EN - NAVI MGR CX3-40 ENTPR LIC	EA	58,000	0%	58,000
15	1	PP-WN-WG - PPATH WINDOWS WGR	EA	1,440	0%	1,440
16	1	PS-BAS-PP1 - POWERPATH 1HOST QS	EA	1,330	0%	1,330
17	1	PS-BAS-PMBLK - POWERPATH 1HOST QS	EA	1,970	0%	1,970
18	1	M-PRESW-001- premium software support	EA	33,929	0%	33,929
19	1	M-PRESW-004 - premium software support - open SW	EA	777	0%	777
20	1	WU-PREHW-001- premium hardware support	EA	31,317	0%	31,317
21	2	QLA2462-E-SP - 2 PORT 4GB PCI-X	EA	1,700	0%	3,400
Hardware summary				\$ 367,875	0%	\$ 367,875
Software summary				\$ 59,760	0%	\$ 59,760
Services summary				\$ 3,300	0%	\$ 3,300
Prepaid software maintenance (3YR-4HOURL)				\$ 34,706	0%	\$ 34,706
Hardware warranty upgrade summary (3YR 4HOURL)				\$ 31,317	0%	\$ 31,317
Total price (usd)						\$ 497,058