



**SPC BENCHMARK 1™
FULL DISCLOSURE REPORT**

**IBM CORPORATION
IBM TOTAL STORAGE
SAN VOLUME CONTROLLER 4.2**

SPC-1 V1.10.1

Submitted for Review: July 12, 2007

Submission Identifier: A00052

First Edition – July 2007

THE INFORMATION CONTAINED IN THIS DOCUMENT IS DISTRIBUTED ON AN AS IS BASIS WITHOUT ANY WARRANTY EITHER EXPRESS OR IMPLIED. The use of this information or the implementation of any of these techniques is the customer's responsibility and depends on the customer's ability to evaluate and integrate them into the customer's operational environment. While each item has been reviewed by IBM Corporation for accuracy in a specific situation, there is no guarantee that the same or similar results will be obtained elsewhere. Customers attempting to adapt these techniques to their own environment do so at their own risk.

This publication was produced in the United States. IBM Corporation may not offer the products, services, or features discussed in this document in other countries, and the information is subject to change with notice. Consult your local IBM Corporation representative for information on products and services available in your area.

© Copyright IBM Corporation 2006. All rights reserved.

Permission is hereby granted to reproduce this document in whole or in part, provided the copyright notice as printed above is set forth in full text on the title page of each item reproduced.

Trademarks

SPC Benchmark-1, SPC-1, SPC-1 IOPS, and SPC-1 LRT are trademarks of the Storage Performance Council. IBM, the IBM logo, and System Storage are trademarks or registered trademarks of IBM Corporation in the United States and other countries. All other brands, trademarks, and product names are the property of their respective owners.

Table of Contents

Audit Certification	vii
Audit Certification (cont.)	viii
Letter of Good Faith	ix
Executive Summary	10
Test Sponsor and Contact Information	10
Revision Information and Key Dates	10
Tested Storage Product (TSP) Description	11
Summary of Results	12
Storage Capacities and Relationships	12
Response Time - Throughput Curve	13
Response Time - Throughput Data	13
Tested Storage Configuration Pricing (Priced Storage Configuration)	14
Differences between the Tested Storage Configuration (TSC) and Priced Storage Configuration	14
Benchmark Configuration/Tested Storage Configuration Diagram	15
Benchmark Configuration/Tested Storage Configuration Components	16
Configuration Information	17
Benchmark Configuration (BC)/Tested Storage Configuration (TSC) Diagram	17
Storage Network Configuration	17
Host System Configuration	17
Customer Tunable Parameters and Options	18
Tested Storage Configuration (TSC) Description	18
SPC-1 Workload Generator Storage Configuration	18
SPC-1 Data Repository	19
Storage Capacities and Relationships	19
SPC-1 Storage Capacities	19
SPC-1 Storage Hierarchy Ratios	19
SPC-1 Storage Capacities and Relationships Illustration	20
Logical Volume Capacity and ASU Mapping	20
SPC-1 Benchmark Execution Results	21
SPC-1 Tests, Test Phases, and Test Runs	21
Primary Metrics Test - Sustainability Test Phase	22
SPC-1 Workload Generator Input Parameters	22
Sustainability Test Results File	22
Sustainability - Data Rate Distribution Data (MB/second).....	23

Sustainability – Data Rate Distribution Graph	24
Sustainability – I/O Request Throughput Distribution Data	25
Sustainability – I/O Request Throughput Distribution Graph	26
Sustainability – Average Response Time (ms) Distribution Data	27
Sustainability – Average Response Time (ms) Distribution Graph	28
Sustainability – Response Time Frequency Distribution Data	29
Sustainability – Response Time Frequency Distribution Graph	29
Sustainability – Measured Intensity Multiplier and Coefficient of Variation.....	30
Primary Metrics Test – IOPS Test Phase	31
SPC-1 Workload Generator Input Parameters	31
IOPS Test Results File.....	31
IOPS Test Run – I/O Request Throughput Distribution Data	32
IOPS Test Run – I/O Request Throughput Distribution Graph.....	32
IOPS Test Run – Average Response Time (ms) Distribution Data	33
IOPS Test Run – Average Response Time (ms) Distribution Graph	33
IOPS Test Run – Response Time Frequency Distribution Data	34
IOPS Test Run –Response Time Frequency Distribution Graph.....	34
IOPS Test Run – I/O Request Information.....	35
IOPS Test Run – Measured Intensity Multiplier and Coefficient of Variation.....	35
Primary Metrics Test – Response Time Ramp Test Phase	36
SPC-1 Workload Generator Input Parameters	36
Response Time Ramp Test Results File.....	36
Response Time Ramp Distribution (IOPS) Data.....	37
Response Time Ramp Distribution (IOPS) Graph	38
SPC-1 LRT™ Average Response Time (ms) Distribution Data.....	39
SPC-1 LRT™ Average Response Time (ms) Distribution Graph	39
SPC-1 LRT™ (10%) – Measured Intensity Multiplier and Coefficient of Variation	40
Repeatability Test	41
SPC-1 Workload Generator Input Parameters	41
Repeatability Test Results File	42
Repeatability 1 LRT – I/O Request Throughput Distribution Data.....	43
Repeatability 1 LRT – I/O Request Throughput Distribution Graph	43
Repeatability 1 LRT –Average Response Time (ms) Distribution Data	44
Repeatability 1 LRT –Average Response Time (ms) Distribution Graph.....	44
Repeatability 1 IOPS – I/O Request Throughput Distribution Data	45
Repeatability 1 IOPS – I/O Request Throughput Distribution Graph.....	45
Repeatability 1 IOPS –Average Response Time (ms) Distribution Data.....	46
Repeatability 1 IOPS –Average Response Time (ms) Distribution Graph	46
Repeatability 2 LRT – I/O Request Throughput Distribution Data.....	47

Repeatability 2 LRT – I/O Request Throughput Distribution Graph	47
Repeatability 2 LRT –Average Response Time (ms) Distribution Data	48
Repeatability 2 LRT –Average Response Time (ms) Distribution Graph.....	48
Repeatability 2 IOPS – I/O Request Throughput Distribution Data	49
Repeatability 2 IOPS – I/O Request Throughput Distribution Graph.....	49
Repeatability 2 IOPS –Average Response Time (ms) Distribution Data.....	50
Repeatability 2 IOPS –Average Response Time (ms) Distribution Graph	50
Repeatability 1 (LRT) Measured Intensity Multiplier and Coefficient of Variation	51
Repeatability 1 (IOPS) Measured Intensity Multiplier and Coefficient of Variation	51
Repeatability 2 (LRT) Measured Intensity Multiplier and Coefficient of Variation	51
Repeatability 2 (IOPS) Measured Intensity Multiplier and Coefficient of Variation	52
Data Persistence Test.....	53
SPC-1 Workload Generator Input Parameters	53
Data Persistence Test Results File	53
Data Persistence Test Results.....	54
Priced Storage Configuration Availability Date.....	55
Pricing Information.....	55
Anomalies or Irregularities	55
Appendix A: SPC-1 Glossary	56
“Decimal” (<i>powers of ten</i>) Measurement Units.....	56
“Binary” (<i>powers of two</i>) Measurement Units.....	56
SPC-1 Data Repository Definitions.....	56
SPC-1 Data Protection Levels	57
SPC-1 Test Execution Definitions	57
I/O Completion Types	59
SPC-1 Test Run Components	59
Appendix B: Customer Tunable Parameters and Options.....	60
Appendix C: Tested Storage Configuration (TSC) Creation	61
Create RAID-10 Arrays (mDisks)	61
Create Definitions for Host System Connectivity	63
Define the mDisk Group	64
Define the vDisks (LUNs)	64
Define vDisk Paths.....	65
Discover each vDisk.....	66
Increase hdisk queue depth.....	66
Create a striped volume group	67

Appendix D: SPC-1 Workload Generator Storage Commands and Parameters 68
Appendix E: SPC-1 Workload Generator Input Parameters 69

AUDIT CERTIFICATION



Bruce McNutt
 IBM Corporation
 KBV/9062-2
 9000 South Rita Road
 Tucson, AZ 8744

July 11, 2007

The SPC Benchmark 1™ results listed below for the IBM System Storage SAN Volume Controller 4.2 were produced in compliance with the SPC Benchmark 1™ V1.10.1 Onsite Audit requirements.

SPC Benchmark 1™ V1.10.1 Results	
Tested Storage Configuration (TSC) Name:	
IBM System Storage SAN Volume Controller 4.2	
Metric	Reported Result
SPC-1 IOPS™	272,505.19
SPC-1 Price-Performance	\$12.05/SPC-1 IOPS™
Total ASU Capacity	24,433,589 GB
Data Protection Level	Mirroring
Total TSC Price (including three-year maintenance)	\$3,284,767

The following SPC Benchmark 1™ Onsite Audit requirements were reviewed and found compliant with V1.10.1 of the SPC Benchmark 1™ specification:

- A Letter of Good Faith, signed by a senior executive.
- The following Data Repository storage items were verified by physical inspection and information supplied by IBM Corporation:
 - ✓ Physical Storage Capacity and requirements.
 - ✓ Configured Storage Capacity and requirements.
 - ✓ Addressable Storage Capacity and requirements.
 - ✓ Capacity of each Logical Volume and requirements.
 - ✓ Capacity of each Application Storage Unit (ASU) and requirements.
- An appropriate diagram of the Benchmark Configuration (BC)/Tested Storage Configuration (TSC).
- Physical verification of the components to match the above diagram.

Storage Performance Council
 643 Bair Island Road, Suite 103
 Redwood City, CA 94062
AuditService@storageperformance.org
 650.556.9384

AUDIT CERTIFICATION (CONT.)

IBM System Storage SAN Volume Controller 4.2
SPC-1 Audit Certification

Page 2

- Listings and commands to configure the Benchmark Configuration/Tested Storage Configuration, including customer tunable parameters.
- Commands and parameters used to configure the SPC-1 Workload Generator.
- The following Host System requirements were verified by physical inspection and information supplied by IBM Corporation:
 - ✓ The type of Host System including the number of processors and main memory.
 - ✓ The presence and version number of the Workload Generator on the Host System.
 - ✓ The TSC boundary within the Host System.
- The execution of each Test, Test Phase, and Test Run was observed and found compliant with all of the requirements and constraints of Clauses 4 and 5 of the SPC-1 Benchmark Specification.
- The Test Results Files and resultant Summary Results Files received from IBM Corporation for each of following were authentic, accurate, and compliant with all of the requirements and constraints of Clauses 4 and 5 of the SPC-1 Benchmark Specification:
 - ✓ Data Persistence Test
 - ✓ Sustainability Test Phase
 - ✓ IOPS Test Phase
 - ✓ Response Time Ramp Test Phase
 - ✓ Repeatability Test
- There were no differences between the Tested Storage Configuration (TSC) used for the benchmark and Priced Storage Configuration.
- The submitted pricing information met all of the requirements and constraints of Clause 8 of the SPC-1 Benchmark Specification.
- The Full Disclosure Report (FDR) met all of the requirements in Clause 9 of the SPC-1 Benchmark Specification.

Audit Notes:

There were no audit notes or exceptions.

Respectfully,

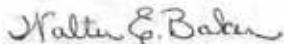

Walter E. Baker
SPC Auditor

Storage Performance Council
643 Bair Island Road, Suite 103
Redwood City, CA 94062
AuditService@storageperformance.org
650.556.9384

LETTER OF GOOD FAITH



Vice President & BLE, Disk Storage
IBM Technology & Systems Group
5600 Cottle Road, San Jose, California 95193

Phone: 408-256-7405
Fax: 408-256-7420

June 15, 2007

Mr. Walter E. Baker, SPC Auditor
Gradient Systems, Inc.
643 Bair Island Road, Suite 103
Redwood City, CA 94063

Subject: SPC-1 Letter of Good Faith for the IBM System Storage San Volume Controller
Version 4.2

IBM Corporation is the SPC-1 Test Sponsor for the above listed product. To the best of our knowledge and belief, the required SPC-1 benchmark results and materials we have submitted for that product are complete, accurate, and in full compliance with Version 1.10.1 of the SPC-1 benchmark specification.

Our disclosure of the Benchmark configuration and execution of the benchmark includes all items that, to the best of our knowledge and belief, materially affect the reported results, regardless of whether such items are explicitly required to be disclosed by the SPC-1 benchmark specification.

Sincerely,

A handwritten signature in black ink, appearing to read "Barry Rudolph".

Barry Rudolph

EXECUTIVE SUMMARY**Test Sponsor and Contact Information**

Test Sponsor and Contact Information	
Test Sponsor Primary Contact	IBM Corporation – http://www.ibm.com Peter Leung – leungp@us.ibm.com 65S/9062-2 9000 South Rita Road Tucson, AZ 85744 Phone: (520) 799-2853 FAX: (520) 799-5530
Test Sponsor Alternate Contact	IBM Corporation – http://www.ibm.com Bruce McNutt – bmcnutt@us.ibm.com KBV/9062-2 9000 South Rita Road Tucson, AZ 85744 Phone: (520) 799-2460 FAX: (520) 799-5530
Auditor	Storage Performance Council – http://www.StoragePerformance.org Walter E. Baker – AuditService@StoragePerformance.org 643 Bair Island Road, Suite 103 Redwood City, CA 94063 Phone: (650) 556-9384 FAX: (650) 556-9385

Revision Information and Key Dates

Revision Information and Key Dates	
SPC-1 Specification revision number	V1.10.1
SPC-1 Workload Generator revision number	V2.00.04a
Date Results were first used publicly	July 12, 2007
Date the FDR was submitted to the SPC	July 12, 2007
Date the TSC is available for shipment to customers	currently available
Date the TSC completed audit certification	July 11, 2007

Tested Storage Product (TSP) Description

The IBM System Storage SAN Volume Controller (SVC) enables a single point of control for disparate, heterogeneous storage resources to help support improved business application availability and greater resource utilization. SAN Volume Controller is designed to pool storage volumes from IBM and non-IBM storage systems into a single reservoir of capacity for centralized management.

SAN Volume Controller combines hardware and software into an integrated, modular solution. Using IBM System x™ server technology in clustered pairs, SAN Volume Controller is designed to avoid potential single points of failure. SAN Volume Controller software is designed to operate as a highly available cluster supporting high performance and ease of use.

SAN Volume Controller is highly scalable. An “I/O Group” is formed by combining a redundant pair of System x servers. Each server includes a four-port 4 Gbps-capable host bus adapter (HBA), designed to allow the SAN Volume Controller to connect and operate at up to 4 Gbps SAN fabric speed. Each I/O Group contains 8 GB of mirrored cache memory. Highly available I/O Groups are the basic configuration element of a SAN Volume Controller cluster. Adding I/O Groups to the cluster is designed to increase cluster performance and bandwidth.

SAN Volume Controller can scale out to support four I/O Groups, and it can scale up to support 1024 host servers. For every cluster, SAN Volume Controller support up to 4096 virtual disks.

Summary of Results

SPC-1 Results	
Tested Storage Configuration (TSC) Name: IBM Total Storage SAN Volume Controller 4.2	
Metric	Reported Result
SPC-1 IOPS™	272,505.19
SPC-1 Price-Performance	\$12.05/SPC-1 IOPS™
Total ASU Capacity	24,433.589 GB
Data Protection Level	Mirroring
Total TSC Price (including three-year maintenance)	\$3,284,767

SPC-1 IOPS™ represents the maximum I/O Request Throughput at the 100% load point.

Total ASU (Application Storage Unit) Capacity represents the total storage capacity read and written in the course of executing the SPC-1 benchmark.

A Data Protection Level of Mirroring configures two or more identical copies of user data.

Storage Capacities and Relationships

The following diagram documents the various storage capacities, used in this benchmark, and their relationships.

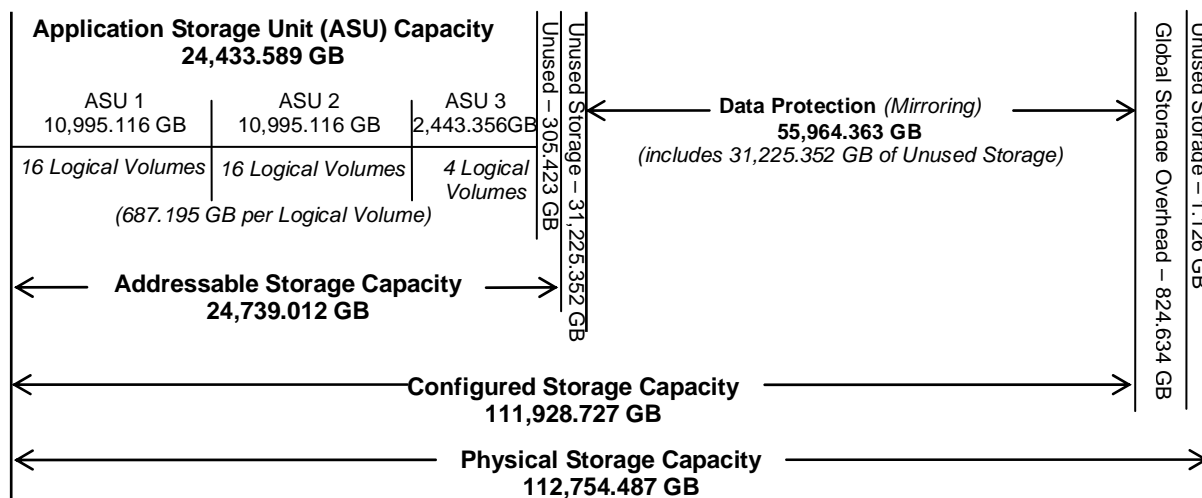

Response Time – Throughput Curve

The Response Time-Throughput Curve illustrates the Average Response Time (milliseconds) and I/O Request Throughput at 100%, 95%, 90%, 80%, 50%, and 10% of the workload level used to generate the SPC-1 IOPS™ metric.

The Average Response Time measured at any of the above load points cannot exceed 30 milliseconds or the benchmark measurement is invalid.

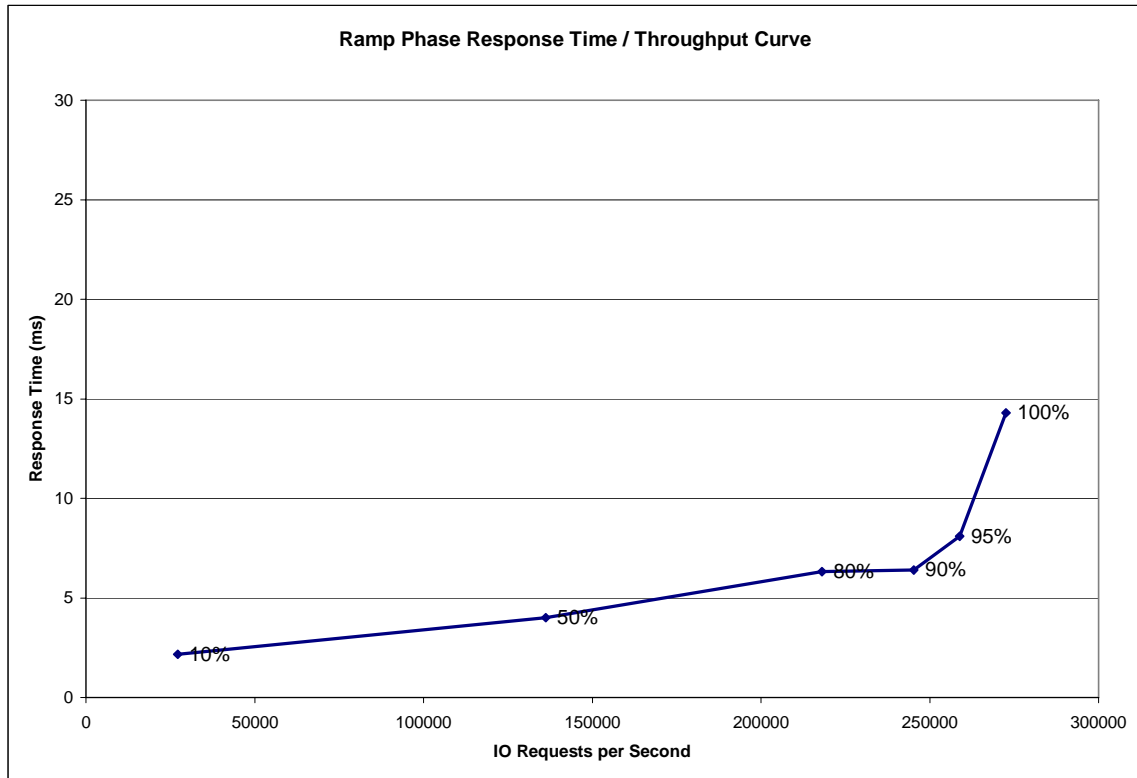

Response Time – Throughput Data

	10% Load	50% Load	80% Load	90% Load	95% Load	100% Load
I/O Request Throughput	27,253.74	136,252.48	217,994.73	245,284.14	258,850.08	272,505.19
Average Response Time (ms):						
All ASUs	2.16	4.02	6.33	6.39	8.10	14.30
ASU-1	2.95	4.77	7.36	7.51	9.06	14.96
ASU-2	2.19	4.54	7.20	7.46	9.08	15.04
ASU-3	0.49	2.18	3.76	3.57	5.62	12.58
Reads	4.81	7.06	10.58	10.97	12.38	17.78
Writes	0.44	2.04	3.56	3.41	5.31	12.04

Tested Storage Configuration Pricing (*Priced Storage Configuration*)

Component	Comments	Quantity	Unit Price	Unit Maint	List w/ Maint	% discount	Total Price
SVC 3550 Storage Engine		8	16,500.00	6,696.00	185,568.00	30	129,897.60
UPS		8	1,250.00	2,592.00	30,736.00	30	21,515.20
Master Console		1	7,499.00	3,816.00	11,315.00	30	7,920.50
SVC Software license	up to 100 virtualized TB	1	332,000.00	132,800.00	464,800.00	30	325,360.00
19 inch rack (7014-T42)		9	3,970.00	1,512.00	49,338.00	50	24,669.00
32 port fibre channel switch (2005-B32)	w/ 32 SFP, 32 ports enabled	4	38,573.00	2,657.00	164,920.00	20	131,936.00
DS 4700 with 16 15K RPM drives (73 GB)	w/ 4 SFP, 2 5m cables	16	43,563	13,950	920,208.00	37	579,731.04
EXP810 with 16 15K RPM drives (73 GB)	w/ 4 SFP, 2 1m cables	80	33,862	5,640	3,160,160.00	37	1,990,900.80
Ethernet switch (73P-2413)		2	135.99	30.00	331.98	42	192.55
Short wave fibre channel cable (5 m)		32	129		4,128.00	20	3,302.40
Short wave fibre channel cable (25 m)		32	189		6,048.00	20	4,838.40
Ethernet cable (7 feet)		8	6.99		55.92	0	55.92
Ethernet cable (25 feet)		32	14.99		479.68	0	479.68
4 Gbit P5 595 adapter (5758)		32	1,999.00		63,968.00	0	63,968.00
Total Price							3,284,767.09

The above pricing provides maintenance/support for 24 hours per day, 7 days per week for three years with four hour acknowledgement and four hour subsequent response (support engineer onsite or customer replaceable part available).

Differences between the Tested Storage Configuration (TSC) and Priced Storage Configuration

There were no differences between the Tested Storage Configuration and the Priced Storage Configuration.

Benchmark Configuration/Tested Storage Configuration Diagram

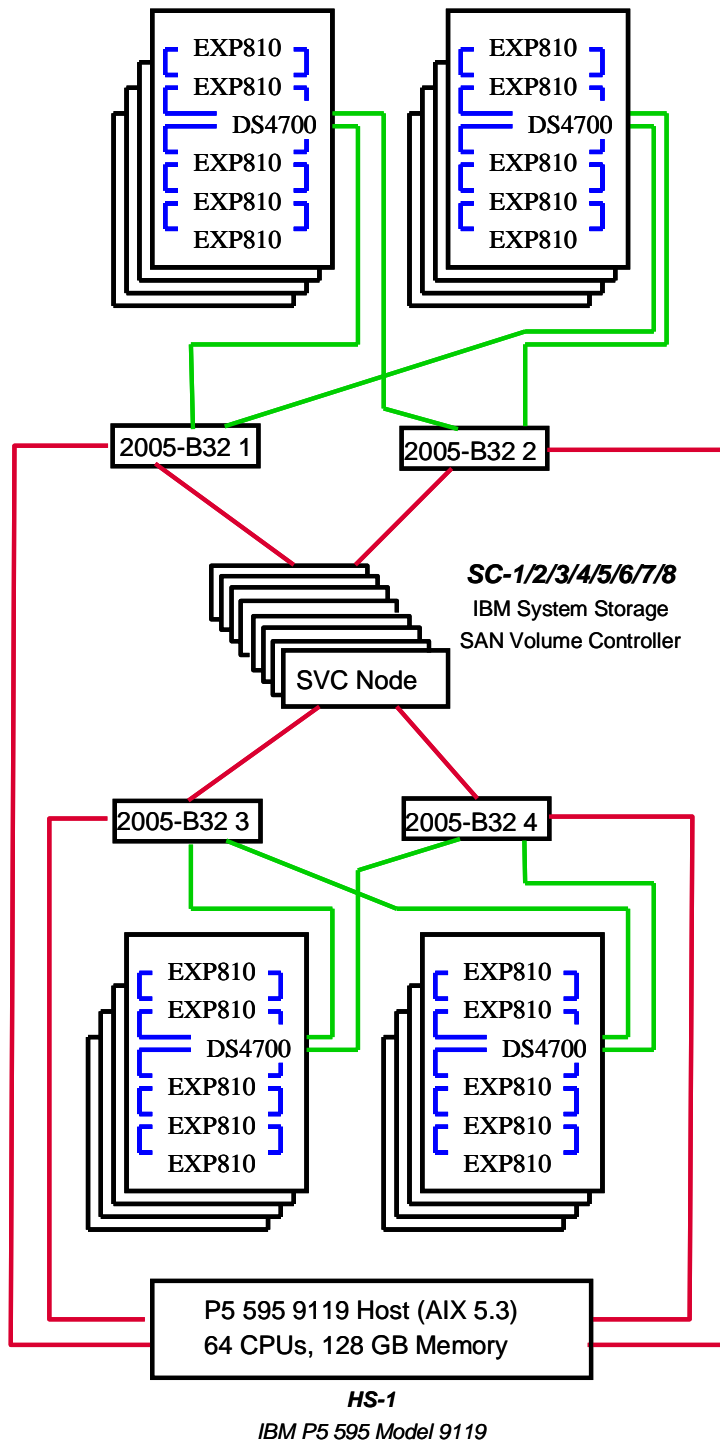

Notes:

All storage is managed by each node (single image).

Each EXP810 and DS4700 has 16 disks (total of 1536). Disks are 73 GB, 15K RPM.

Each switch has one zone for node-to-storage traffic, two zones for node-to-host traffic (even nodes to half of fcs's, odd nodes to half of fcs's).

- Represents 1 FC path per line drawn
- Represents 4 FC paths per line drawn
- Represents 8 FC paths per line drawn

Benchmark Configuration/Tested Storage Configuration Components

Host Systems:	Tested Storage Configuration (TSC):
<i>UID=HS-1</i>	32 – 4 Gbit P5 595 HBAs
IBM P5 595 Model 9119	<i>UID=SC-1/2/3/4/5/6/7/8:</i> 8 – TotalStorage® SAN Volume Controllers
64 – 1.9 GHz CPUs – 2 CPUs/POWER5 chip 32 KB L1 cache, 960 KB L2 cache, and 18 MB L3 cache per CPU	per controller: 2 – 2.333 GHz Intel Xeon Dual-Core CPUs 864 MiB data cache
128 GB main memory	160 MiB processor cache
AIX 5.3	4 – 4 Gbit FC ports
PCI-X/RIO	4 – 32 port FC switches
WG	2 – Ethernet switch
	16 – DS4700 enclosures
	80 – EXP810 enclosures
	16 – 73 GB, 15K RPM disk drives per enclosure
	9 – 19 inch racks
	8 – UPS

In each of the following sections of this document, the appropriate Full Disclosure Report requirement, from the SPC-1 benchmark specification, is stated in italics followed by the information to fulfill the stated requirement.

CONFIGURATION INFORMATION

Benchmark Configuration (BC)/Tested Storage Configuration (TSC) Diagram

Clause 9.2.4.4.1

A one page Benchmark Configuration (BC)/Tested Storage Configuration (TSC) diagram shall be included in the Executive Summary...

The Benchmark Configuration (BC)/Tested Storage Configuration (TSC) is illustrated on page 15 (*Benchmark Configuration/Tested Storage Configuration Diagram*).

Storage Network Configuration

Clause 9.2.4.4.1

...

5. *If the TSC contains network storage, the diagram will include the network configuration. If a single diagram is not sufficient to illustrate both the Benchmark Configuration and network configuration in sufficient detail, the Benchmark Configuration diagram will include a high-level network illustration as shown in Figure 9-8. In that case, a separate, detailed network configuration diagram will also be included as described in Clause 9.2.4.4.2.*

Clause 9.2.4.4.2

If a storage network was configured as a part of the Tested Storage Configuration and the Benchmark Configuration diagram described in Clause 9.2.4.4.1 contains a high-level illustration of the network configuration, the Executive Summary will contain a one page topology diagram of the storage network as illustrated in Figure 9-9.

The Benchmark Configuration (BC)/Tested Storage Configuration (TSC) was configured with local storage and, as such, did not employ a storage network.

Host System Configuration

Clause 9.2.4.4.3

The FDR shall minimally contain, for each Host System running the Workload Generator, a listing of the following:

1. *Number and type of CPUs.*
2. *Main memory capacity.*
3. *Cache memory capacity.*
4. *Number and type of disk controllers or Host Bus Adapters.*

The details of the Host System configuration may be found on page 15 (*Benchmark Configuration/Tested Storage Configuration Diagram*).

Customer Tunable Parameters and Options

Clause 9.2.4.5.1

All Benchmark Configuration (BC) components with customer tunable parameter and options that have been altered from their default values must be listed in the FDR. The FDR entry for each of those components must include both the name of the component and the altered value of the parameter or option. If the parameter name is not self-explanatory to a knowledgeable practitioner, a brief description of the parameter's use must also be included in the FDR entry.

“Appendix B: Customer Tunable Parameters and Options” on page 60 contains the customer tunable parameters and options that have been altered from their default values for this benchmark.

Tested Storage Configuration (TSC) Description

Clause 9.2.4.5.2

The FDR must include sufficient information to recreate the logical representation of the TSC. In addition to customer tunable parameters and options (Clause 4.2.4.5.3), that information must include, at a minimum:

- A diagram and/or description of the following:
 - All physical components that comprise the TSC. Those components are also illustrated in the BC Configuration Diagram in Clause 9.2.4.4.1 and/or the Storage Network Configuration Diagram in Clause 9.2.4.4.2.
 - The logical representation of the TSC, configured from the above components that will be presented to the Workload Generator.
- Listings of scripts used to create the logical representation of the TSC.
- If scripts were not used, a description of the process used with sufficient detail to recreate the logical representation of the TSC.

“Appendix C: Tested Storage Configuration (TSC) Creation” on page 61 contains the detailed information that describes how to create and configure the logical TSC.

SPC-1 Workload Generator Storage Configuration

Clause 9.2.4.5.3

The FDR must include all SPC-1 Workload Generator storage configuration commands and parameters.

The SPC-1 Workload Generator storage configuration commands and parameters for this measurement appear in “Appendix D: SPC-1 Workload Generator Storage Commands and Parameters” on page 68.

SPC-1 DATA REPOSITORY

This portion of the Full Disclosure Report presents the detailed information that fully documents the various SPC-1 storage capacities and mappings used in the Tested Storage Configuration. “SPC-1 Data Repository Definitions” on page 56 contains definitions of terms specific to the SPC-1 Data Repository.

Storage Capacities and Relationships

Clause 9.2.4.6.1

Two tables and an illustration documenting the storage capacities and relationships of the SPC-1 Storage Hierarchy (Clause 2.1) shall be included in the FDR.

SPC-1 Storage Capacities

SPC-1 Storage Capacities		
Storage Hierarchy Component	Units	Capacity
Total ASU Capacity	Gigabytes (GB)	24,433.589
Addressable Storage Capacity	Gigabytes (GB)	24,739.012
Configured Storage Capacity	Gigabytes (GB)	111,928.727
Physical Storage Capacity	Gigabytes (GB)	112,754.487
Data Protection (Mirroring)	Gigabytes (GB)	26,353.919
Required Storage	Gigabytes (GB)	0.000
Global Storage Overhead	Gigabytes (GB)	824.634
Total Unused Storage	Gigabytes (GB)	62,757.253

SPC-1 Storage Hierarchy Ratios

	Addressable Storage Capacity	Configured Storage Capacity	Physical Storage Capacity
Total ASU Capacity	98.77%	21.83%	21.67%
Required for Data Protection (Mirroring)		23.55%	23.37%
Addressable Storage Capacity		22.10%	21.94%
Required Storage		0.00%	0.00%
Configured Storage Capacity			99.27%
Global Storage Overhead			0.73%
Unused Storage:			
Addressable	1.23%		
Configured		55.80%	
Physical			0.00%

The Physical Storage Capacity consisted of 112,754.487 GB distributed over 1,536 disk drives each with a formatted capacity of 73.408 GB. There was GB (0.001%) of Unused Storage within the Physical Storage Capacity. Global Storage Overhead consisted of 824.634 GB (0.73%) of Physical Storage Capacity. There was 62,450.704 GB (55.80%) of Unused Storage within the Configured Storage Capacity. The Total ASU Capacity utilized 98.77% of the Addressable Storage Capacity resulting in 305.423 GB (1.23%) of Unused Storage within the Addressable Storage Capacity.

SPC-1 Storage Capacities and Relationships Illustration

The various storage capacities configured in the benchmark result are illustrated below (not to scale).

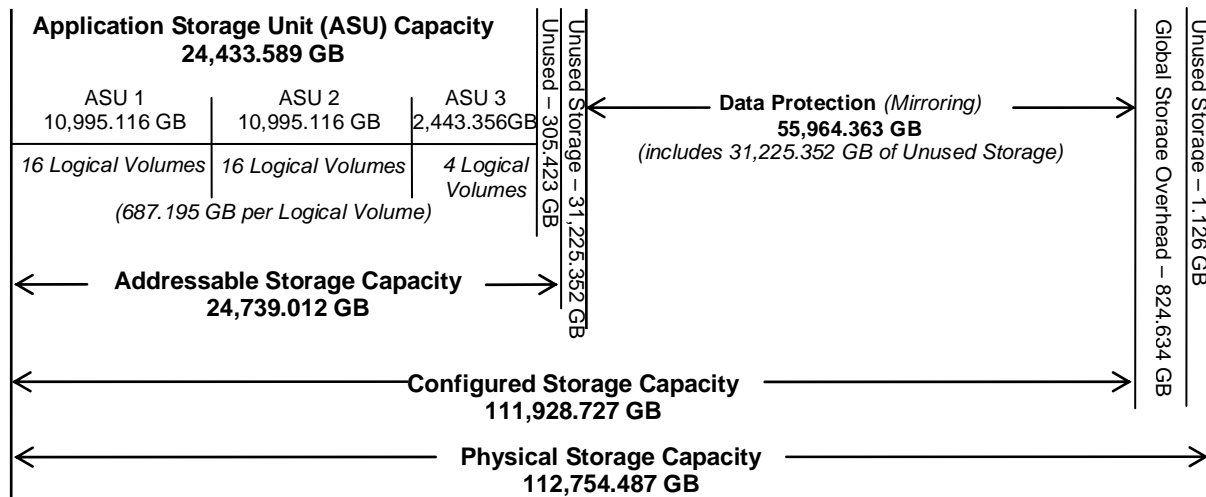

Logical Volume Capacity and ASU Mapping

Clause 9.2.4.6.2

A table illustrating the capacity of each ASU and the mapping of Logical Volumes to ASUs shall be provided in the FDR. ... Logical Volumes shall be sequenced in the table from top to bottom per its position in the contiguous address space of each ASU. The capacity of each Logical Volume shall be stated. ... In conjunction with this table, the Test Sponsor shall provide a complete description of the type of data protection (see Clause 2.4.5) used on each Logical Volume.

Logical Volume Capacity and Mapping		
ASU-1 (10,995.116 GB)	ASU-2 (GB)	ASU-3 (GB)
16 Logical Volume 687.195 GB per Logical Volume (687.195 GB used per Logical Volume)	16 Logical Volume 687.195 GB per Logical Volume (687.195 GB used per Logical Volume)	4 Logical Volume 687.195 GB per Logical Volume (610.830 GB used per Logical Volume)

The Data Protection Level used for all Logical Volumes was Mirroring as described on page 12. See “ASU Configuration” in the [IOPS Test Results File](#) for more detailed configuration information.

SPC-1 BENCHMARK EXECUTION RESULTS

This portion of the Full Disclosure Report documents the results of the various SPC-1 Tests, Test Phases, and Test Runs. “SPC-1 Test Execution Definitions” on page 57 contains definitions of terms specific to the SPC-1 Tests, Test Phases, and Test Runs.

Clause 5.4.3

The Tests must be executed in the following sequence: Primary Metrics, Repeatability, and Data Persistence. That required sequence must be uninterrupted from the start of Primary Metrics to the completion of Persistence Test Run 1. Uninterrupted means the Benchmark Configuration shall not be power cycled, restarted, disturbed, altered, or adjusted during the above measurement sequence. If the required sequence is interrupted other than for the Host System/TSC power cycle between the two Persistence Test Runs, the measurement is invalid.

SPC-1 Tests, Test Phases, and Test Runs

The SPC-1 benchmark consists of the following Tests, Test Phases, and Test Runs:

- **Primary Metrics Test**
 - Sustainability Test Phase and Test Run
 - IOPS Test Phase and Test Run
 - Response Time Ramp Test Phase
 - 95% of IOPS Test Run
 - 90% of IOPS Test Run
 - 80% of IOPS Test Run
 - 50% of IOPS Test Run
 - 10% of IOPS Test Run (LRT)
- **Repeatability Test**
 - Repeatability Test Phase 1
 - 10% of IOPS Test Run (LRT)
 - IOPS Test Run
 - Repeatability Test Phase 2
 - 10% of IOPS Test Run (LRT)
 - IOPS Test Run
- **Data Persistence Test**
 - Data Persistence Test Run 1
 - Data Persistence Test Run 2

Each Test is an atomic unit that must be executed from start to finish before any other Test, Test Phase, or Test Run may be executed.

The results from each Test, Test Phase, and Test Run are listed below along with a more detailed explanation of each component.

Primary Metrics Test – Sustainability Test Phase

Clause 5.4.4.1.1

The Sustainability Test Phase has exactly one Test Run and shall demonstrate the maximum sustainable I/O Request Throughput within at least a continuous three (3) hour Measurement Interval. This Test Phase also serves to insure that the TSC has reached Steady State prior to reporting the final maximum I/O Request Throughput result (SPC-1 IOPS™).

Clause 5.4.4.1.2

The computed I/O Request Throughput of the Sustainability Test must be within 5% of the reported SPC-1 IOPS™ result.

Clause 5.4.4.1.4

The Average Response Time, as defined in Clause 5.1.1, will be computed and reported for the Sustainability Test Run and cannot exceed 30 milliseconds. If the Average Response time exceeds that 30-milliseconds constraint, the measurement is invalid.

Clause 9.2.4.7.1

For the Sustainability Test Phase the FDR shall contain:

- 1. A Data Rate Distribution graph and data table.*
- 2. I/O Request Throughput Distribution graph and data table.*
- 3. A Response Time Frequency Distribution graph and table.*
- 4. An Average Response Time Distribution graph and table.*
- 5. The human readable Test Run Results File produced by the Workload Generator (may be included in an appendix).*
- 6. A listing or screen image of all input parameters supplied to the Workload Generator (may be included in an appendix).*
- 7. The Measured Intensity Multiplier for each I/O stream.*
- 8. The variability of the Measured Intensity Multiplier, as defined in Clause 5.3.13.3.*

SPC-1 Workload Generator Input Parameters

The SPC-1 Workload Generator input parameters for the Sustainability, IOPS, Response Time Ramp, Repeatability, and Persistence Test Runs are documented in “Appendix E: SPC-1 Workload Generator Input Parameters” on Page 69.

Sustainability Test Results File

A link to the test results file generated from the Sustainability Test Run is listed below.

[Sustainability Test Results File](#)

Sustainability – Data Rate Distribution Data (MB/second)

	Start	Stop	Interval	Duration										
Ramp-Up/Start-Up	16:05:55	16:08:55	0-2	0:03:00										
Measurement Interval	16:08:55	19:08:57	3-182	3:00:02										
Interval	All ASUs	ASU1	ASU2	ASU3	Interval	All ASUs	ASU1	ASU2	ASU3	Interval	All ASUs	ASU1	ASU2	ASU3
0	2,243.70	870.90	239.62	1,133.18	63	2,235.20	868.03	238.87	1,128.30	126	2,236.04	868.52	238.29	1,129.24
1	2,234.54	868.48	238.62	1,127.44	64	2,235.99	868.87	238.79	1,128.33	127	2,236.48	868.62	238.91	1,128.95
2	2,236.54	868.16	238.49	1,129.88	65	2,237.73	868.45	238.58	1,130.70	128	2,239.10	869.27	238.68	1,131.15
3	2,236.55	868.48	238.67	1,129.39	66	2,236.23	867.42	239.06	1,129.75	129	2,238.61	868.68	239.33	1,130.59
4	2,238.60	868.82	238.95	1,130.82	67	2,240.51	869.88	239.62	1,131.01	130	2,236.31	868.31	239.48	1,128.51
5	2,237.40	868.20	238.76	1,130.44	68	2,236.71	867.87	238.97	1,129.87	131	2,235.89	868.49	238.34	1,129.06
6	2,235.53	868.54	238.55	1,128.44	69	2,237.59	868.85	238.96	1,129.78	132	2,237.69	868.92	239.08	1,129.70
7	2,237.47	868.80	239.22	1,129.46	70	2,237.12	868.34	238.95	1,129.84	133	2,239.73	868.46	239.25	1,132.01
8	2,236.53	868.35	238.89	1,129.30	71	2,239.11	868.79	239.25	1,131.07	134	2,234.83	867.61	238.37	1,128.85
9	2,239.58	868.65	239.46	1,131.47	72	2,236.36	868.35	238.68	1,129.33	135	2,234.79	867.64	238.85	1,128.30
10	2,236.59	868.17	238.94	1,129.48	73	2,239.53	869.97	239.08	1,130.48	136	2,238.74	868.61	238.94	1,131.19
11	2,236.69	868.12	239.45	1,129.12	74	2,237.42	868.21	238.69	1,130.53	137	2,236.58	868.67	238.85	1,129.06
12	2,235.39	867.77	238.93	1,128.68	75	2,237.43	868.54	239.04	1,129.86	138	2,236.15	868.55	238.93	1,128.68
13	2,235.16	868.35	238.48	1,128.33	76	2,236.98	868.40	238.55	1,130.03	139	2,236.27	867.91	238.89	1,129.47
14	2,239.19	868.30	239.13	1,131.76	77	2,238.50	869.09	238.59	1,130.82	140	2,237.34	868.18	238.87	1,130.29
15	2,237.20	868.62	238.29	1,130.29	78	2,237.06	867.78	238.93	1,130.34	141	2,238.55	869.02	239.13	1,130.41
16	2,236.58	868.73	239.05	1,128.80	79	2,234.79	867.90	238.85	1,128.04	142	2,235.85	868.25	238.87	1,128.73
17	2,237.83	868.37	239.69	1,129.77	80	2,233.72	867.39	238.77	1,127.56	143	2,237.95	869.40	238.85	1,129.70
18	2,237.05	867.66	239.15	1,130.24	81	2,239.34	869.51	239.34	1,130.48	144	2,236.32	868.22	239.30	1,128.80
19	2,236.96	868.83	238.72	1,129.40	82	2,238.14	869.35	239.02	1,129.77	145	2,239.64	868.73	239.05	1,131.87
20	2,236.42	868.20	239.04	1,129.18	83	2,235.01	867.54	239.48	1,127.99	146	2,236.64	868.61	238.86	1,129.23
21	2,233.83	866.31	238.67	1,128.84	84	2,234.97	868.18	238.75	1,128.04	147	2,238.46	868.09	238.87	1,131.51
22	2,242.32	870.29	239.36	1,132.67	85	2,237.58	868.77	238.92	1,129.89	148	2,237.79	868.88	239.25	1,129.65
23	2,236.58	868.30	238.90	1,129.38	86	2,237.83	869.04	238.56	1,130.23	149	2,239.99	870.27	238.79	1,130.92
24	2,236.29	868.61	238.85	1,128.83	87	2,236.17	868.35	238.95	1,128.87	150	2,237.10	868.72	238.47	1,129.91
25	2,236.40	868.17	238.20	1,130.03	88	2,238.97	868.56	239.25	1,131.16	151	2,234.26	868.26	238.67	1,127.33
26	2,235.54	868.57	238.62	1,128.36	89	2,237.60	868.52	239.07	1,130.01	152	2,238.02	869.16	239.02	1,129.85
27	2,236.46	867.76	238.84	1,129.87	90	2,238.73	868.66	239.70	1,130.37	153	2,236.63	868.12	238.72	1,129.79
28	2,236.48	868.37	239.19	1,128.92	91	2,238.35	868.88	239.03	1,130.44	154	2,237.52	868.19	239.33	1,130.01
29	2,235.92	868.40	239.16	1,128.36	92	2,239.02	868.68	238.93	1,131.41	155	2,236.12	867.50	238.66	1,129.96
30	2,235.41	868.16	238.83	1,128.41	93	2,235.25	867.11	238.84	1,129.30	156	2,236.94	868.50	238.80	1,129.64
31	2,239.30	869.27	239.44	1,130.59	94	2,239.64	869.74	239.35	1,130.56	157	2,237.31	868.89	239.02	1,129.40
32	2,235.98	868.39	238.58	1,129.01	95	2,234.00	868.08	238.40	1,127.52	158	2,239.55	867.76	238.69	1,129.76
33	2,239.44	868.96	239.22	1,131.26	96	2,238.35	868.53	238.83	1,130.99	159	2,234.67	867.79	238.53	1,128.35
34	2,235.90	868.22	238.65	1,129.03	97	2,239.94	869.49	238.95	1,131.50	160	2,233.25	867.88	238.39	1,126.98
35	2,236.16	868.25	239.23	1,128.68	98	2,237.61	868.77	239.17	1,129.66	161	2,235.80	868.11	238.94	1,128.75
36	2,236.64	868.36	238.51	1,129.77	99	2,237.46	868.90	239.40	1,129.17	162	2,239.00	868.38	239.01	1,131.61
37	2,238.95	868.85	239.29	1,130.81	100	2,236.03	867.72	239.24	1,129.08	163	2,239.55	869.56	238.89	1,131.11
38	2,239.56	869.27	239.88	1,130.41	101	2,237.79	868.52	238.69	1,130.58	164	2,237.32	869.17	239.48	1,128.68
39	2,235.80	868.57	238.74	1,128.49	102	2,238.38	869.47	238.70	1,130.21	165	2,237.72	867.94	239.28	1,130.50
40	2,236.72	868.01	239.08	1,129.63	103	2,238.13	868.45	238.86	1,130.82	166	2,239.35	868.74	239.40	1,131.22
41	2,240.63	869.27	239.68	1,131.68	104	2,237.42	867.96	238.97	1,130.49	167	2,238.03	868.61	238.98	1,130.44
42	2,237.01	868.09	238.54	1,130.38	105	2,235.18	868.26	238.50	1,128.42	168	2,236.47	868.49	238.73	1,129.26
43	2,235.72	867.99	239.20	1,128.54	106	2,237.07	868.32	239.19	1,129.55	169	2,236.05	869.31	238.50	1,128.23
44	2,238.17	868.67	238.90	1,130.61	107	2,237.69	868.63	238.69	1,130.37	170	2,236.34	868.58	239.14	1,128.62
45	2,236.35	868.47	238.84	1,129.05	108	2,237.94	867.75	239.10	1,131.10	171	2,236.08	868.58	238.84	1,128.67
46	2,239.46	869.59	238.88	1,130.99	109	2,236.49	867.92	238.96	1,129.61	172	2,236.98	868.52	238.51	1,129.94
47	2,234.16	868.15	238.53	1,127.49	110	2,236.78	868.75	239.18	1,128.84	173	2,239.85	868.76	239.34	1,131.74
48	2,236.75	867.85	238.91	1,129.99	111	2,235.46	868.84	238.89	1,127.73	174	2,239.10	869.19	239.50	1,130.41
49	2,240.10	868.81	239.40	1,131.89	112	2,237.84	868.50	238.93	1,130.40	175	2,239.42	869.11	239.50	1,130.81
50	2,233.38	868.02	238.43	1,126.93	113	2,235.81	868.67	238.92	1,128.23	176	2,236.44	868.36	238.71	1,129.37
51	2,237.58	868.65	238.92	1,130.01	114	2,238.36	869.62	239.26	1,129.48	177	2,236.52	868.58	238.88	1,129.05
52	2,235.11	868.45	238.13	1,128.53	115	2,238.14	868.94	238.90	1,130.31	178	2,238.03	869.39	238.94	1,129.70
53	2,237.14	868.32	238.84	1,129.98	116	2,237.61	868.96	239.01	1,129.64	179	2,237.81	869.08	239.21	1,129.52
54	2,231.09	866.79	238.19	1,126.11	117	2,238.48	868.32	239.32	1,130.85	180	2,236.20	867.96	238.75	1,129.50
55	2,238.25	868.74	239.20	1,130.31	118	2,237.26	868.82	238.75	1,129.69	181	2,237.94	868.54	239.26	1,130.15
56	2,235.99	868.52	238.48	1,128.99	119	2,236.16	868.89	238.83	1,128.44	182	2,237.52	868.33	238.93	1,130.26
57	2,235.77	867.92	239.31	1,128.54	120	2,235.46	868.66	238.58	1,128.22					
58	2,235.29	867.69	238.66	1,128.95	121	2,235.97	868.27	238.76	1,128.95					
59	2,238.20	868.40	238.83	1,130.97	122	2,237.05	868.68	239.28	1,129.09					
60	2,237.49	868.30	239.16	1,130.03	123	2,236.66	868.76	238.93	1,128.97					
61	2,236.09	868.47	238.85	1,128.77	124	2,240.38	869.40	239.51	1,131.47					
62	2,240.62	869.38	239.11	1,132.13	125	2,239.70	868.84	239.43	1,131.43					

Sustainability – Data Rate Distribution Graph

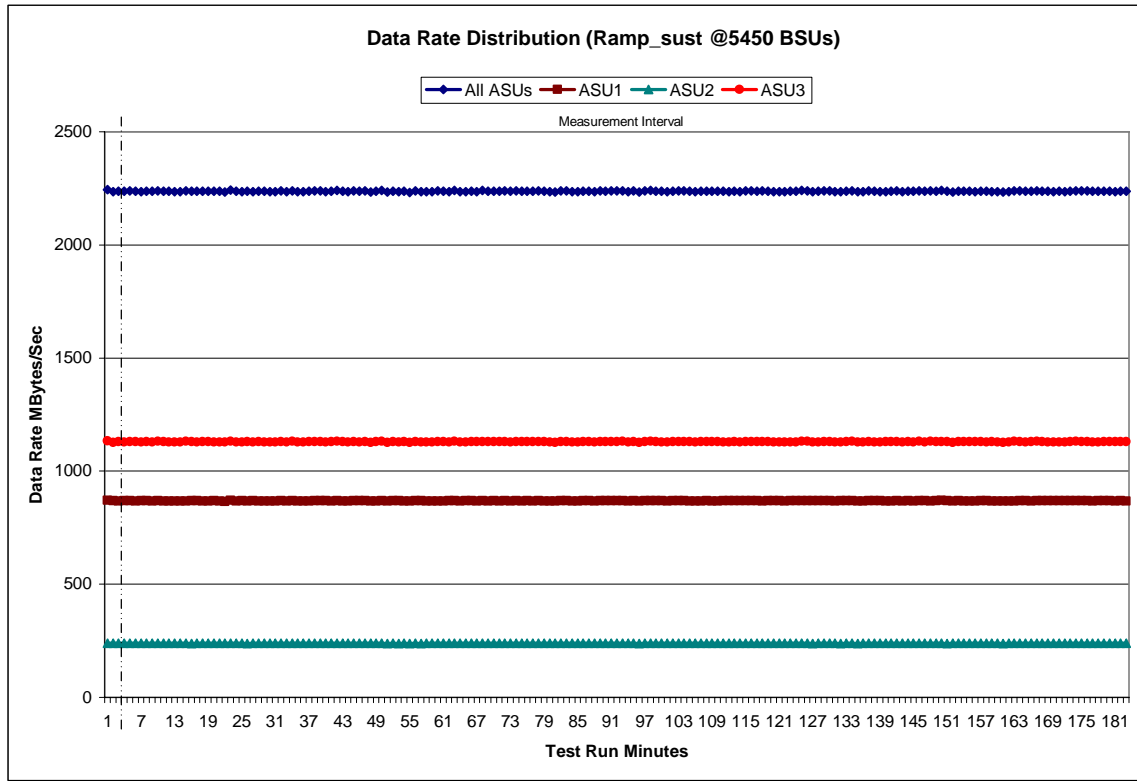

Sustainability – I/O Request Throughput Distribution Data

	Start	Stop	Interval	Duration										
Ramp-Up/Start-Up	16:05:55	16:08:55	0-2	0:03:00										
Measurement Interval	16:08:55	19:08:57	3-182	3:00:02										
Interval	All ASUs	ASU1	ASU2	ASU3	Interval	All ASUs	ASU1	ASU2	ASU3	Interval	All ASUs	ASU1	ASU2	ASU3
0	273,194.40	162,792.20	33,638.30	76,763.90	63	272,419.35	162,363.95	33,504.65	76,550.75	126	272,457.02	162,437.38	33,459.63	76,560.00
1	272,456.17	162,389.65	33,523.93	76,542.58	64	272,491.72	162,462.85	33,537.50	76,491.37	127	272,419.35	162,430.38	33,462.98	76,525.98
2	272,467.72	162,376.33	33,496.33	76,595.05	65	272,411.97	162,307.22	33,499.58	76,605.17	128	272,547.55	162,490.12	33,481.00	76,576.43
3	272,471.70	162,418.95	33,501.65	76,551.10	66	272,088.90	162,134.50	33,501.63	76,452.77	129	272,474.05	162,401.35	33,528.57	76,544.13
4	272,551.67	162,452.77	33,502.75	76,596.15	67	272,919.63	162,649.35	33,573.07	76,697.22	130	272,518.35	162,407.20	33,542.55	76,568.60
5	272,565.77	162,413.37	33,520.18	76,632.22	68	272,424.42	162,354.05	33,526.60	76,543.77	131	272,515.75	162,463.33	33,462.58	76,589.83
6	272,503.38	162,447.18	33,498.57	76,557.63	69	272,556.78	162,390.92	33,512.85	76,653.02	132	272,475.28	162,488.37	33,496.80	76,490.12
7	272,510.73	162,424.98	33,525.53	76,560.22	70	272,449.75	162,394.87	33,506.92	76,547.97	133	272,438.27	162,381.10	33,500.05	76,557.12
8	272,464.97	162,376.53	33,517.27	76,571.17	71	272,539.37	162,428.52	33,539.60	76,571.25	134	272,365.78	162,333.45	33,469.98	76,562.35
9	272,513.52	162,383.87	33,565.15	76,564.50	72	272,478.82	162,416.07	33,514.60	76,548.15	135	272,157.77	162,188.63	33,488.10	76,481.03
10	272,567.48	162,428.00	33,554.42	76,585.07	73	272,490.82	162,427.77	33,510.70	76,552.35	136	272,802.52	162,546.68	33,557.22	76,698.62
11	272,515.93	162,396.20	33,517.60	76,602.13	74	272,527.27	162,476.77	33,472.73	76,577.77	137	272,537.93	162,475.38	33,505.53	76,557.02
12	272,480.63	162,377.98	33,529.67	76,572.98	75	272,616.15	162,490.87	33,540.68	76,584.60	138	272,528.40	162,454.63	33,498.93	76,574.83
13	272,471.57	162,381.32	33,524.25	76,566.00	76	272,454.48	162,427.37	33,444.58	76,582.53	139	272,244.38	162,239.28	33,499.07	76,506.03
14	272,613.12	162,410.05	33,554.48	76,648.58	77	272,469.88	162,455.87	33,484.17	76,529.85	140	272,624.07	162,468.55	33,510.40	76,645.12
15	272,454.68	162,399.65	33,501.08	76,553.95	78	272,420.03	162,347.35	33,508.33	76,564.35	141	272,626.93	162,502.87	33,539.23	76,584.83
16	272,497.58	162,460.67	33,538.65	76,498.27	79	272,410.73	162,339.90	33,501.15	76,569.68	142	272,526.10	162,384.85	33,540.23	76,601.02
17	272,443.77	162,333.73	33,578.70	76,531.33	80	272,434.25	162,406.28	33,507.25	76,520.72	143	272,455.10	162,381.03	33,516.43	76,557.63
18	272,486.77	162,435.58	33,476.75	76,574.43	81	272,652.23	162,522.18	33,543.72	76,586.33	144	272,507.85	162,446.58	33,507.90	76,553.37
19	272,447.33	162,435.25	33,499.18	76,512.90	82	272,462.63	162,399.30	33,520.82	76,542.52	145	272,612.37	162,483.62	33,508.97	76,619.78
20	272,535.53	162,409.12	33,530.65	76,595.77	83	272,427.73	162,343.92	33,533.88	76,549.93	146	272,505.32	162,487.25	33,527.97	76,490.10
21	271,945.50	162,054.20	33,435.50	76,455.80	84	272,400.47	162,420.77	33,490.98	76,488.72	147	272,477.33	162,427.28	33,497.22	76,552.83
22	272,982.93	162,677.20	33,596.22	76,709.52	85	272,534.40	162,417.03	33,532.63	76,584.73	148	272,524.03	162,444.88	33,509.47	76,569.68
23	272,417.03	162,363.85	33,491.42	76,561.77	86	272,627.12	162,480.78	33,509.60	76,636.73	149	272,670.73	162,533.88	33,509.38	76,627.47
24	272,457.50	162,401.90	33,523.95	76,531.65	87	272,549.97	162,447.77	33,494.98	76,607.22	150	272,563.93	162,459.50	33,496.20	76,608.23
25	272,485.73	162,402.20	33,479.85	76,603.68	88	272,435.53	162,324.27	33,541.72	76,569.55	151	272,402.80	162,383.80	33,516.07	76,502.93
26	272,467.47	162,387.28	33,477.58	76,602.60	89	272,546.45	162,457.78	33,502.82	76,586.18	152	272,559.68	162,481.43	33,518.70	76,559.55
27	272,554.12	162,364.50	33,552.53	76,637.08	90	272,497.18	162,399.45	33,516.45	76,581.28	153	272,542.92	162,385.08	33,518.80	76,639.03
28	272,637.62	162,490.97	33,531.63	76,615.02	91	272,532.93	162,410.78	33,526.95	76,595.20	154	272,557.38	162,410.82	33,550.48	76,596.08
29	272,519.22	162,418.67	33,550.55	76,550.00	92	272,495.75	162,345.97	33,522.68	76,627.10	155	272,449.50	162,355.08	33,511.75	76,582.67
30	272,493.45	162,413.65	33,541.50	76,538.30	93	272,176.17	162,229.42	33,443.60	76,503.15	156	272,601.28	162,436.25	33,497.78	76,667.25
31	272,641.73	162,436.55	33,548.13	76,657.05	94	272,829.60	162,588.90	33,565.83	76,674.87	157	272,481.83	162,441.65	33,487.48	76,552.70
32	272,413.02	162,381.28	33,481.38	76,550.35	95	272,469.95	162,415.28	33,498.63	76,556.03	158	272,340.83	162,277.05	33,489.55	76,574.23
33	272,553.65	162,398.22	33,498.12	76,657.32	96	272,563.45	162,429.08	33,497.58	76,636.78	159	272,484.73	162,371.35	33,499.53	76,613.85
34	272,517.88	162,402.52	33,492.95	76,622.42	97	272,598.98	162,486.93	33,507.53	76,604.52	160	272,392.23	162,383.63	33,475.63	76,532.97
35	272,464.70	162,389.67	33,525.87	76,549.17	98	272,423.20	162,360.32	33,526.82	76,554.07	161	272,549.93	162,395.60	33,521.38	76,632.95
36	272,542.87	162,462.42	33,501.00	76,579.45	99	272,602.98	162,441.53	33,539.55	76,621.90	162	272,506.95	162,363.10	33,514.40	76,629.45
37	272,467.53	162,375.95	33,515.02	76,576.57	100	272,444.88	162,338.52	33,536.62	76,569.75	163	272,493.80	162,395.33	33,547.65	76,550.82
38	272,688.48	162,540.33	33,530.43	76,617.72	101	272,468.82	162,363.48	33,520.98	76,584.35	164	272,499.13	162,376.85	33,563.28	76,559.00
39	272,552.05	162,452.37	33,528.50	76,571.18	102	272,515.22	162,442.15	33,511.00	76,562.07	165	272,381.65	162,305.43	33,518.77	76,557.45
40	272,435.68	162,382.77	33,484.22	76,568.70	103	272,478.57	162,408.68	33,518.05	76,551.83	166	272,592.90	162,466.12	33,521.98	76,604.80
41	272,541.33	162,434.72	33,533.07	76,573.55	104	272,512.10	162,410.30	33,531.65	76,570.15	167	272,531.97	162,443.25	33,513.20	76,575.52
42	272,393.68	162,325.52	33,491.28	76,576.88	105	272,441.93	162,400.93	33,502.47	76,538.53	168	272,571.37	162,513.25	33,497.05	76,561.07
43	272,320.10	162,336.95	33,513.13	76,470.02	106	272,511.27	162,430.22	33,527.08	76,553.97	169	272,560.37	162,475.57	33,508.10	76,576.70
44	272,510.77	162,450.72	33,484.63	76,575.42	107	272,560.87	162,452.25	33,503.47	76,605.15	170	272,507.60	162,390.10	33,536.42	76,581.08
45	272,461.82	162,418.35	33,511.78	76,531.68	108	272,365.07	162,254.58	33,514.00	76,596.48	171	272,523.38	162,472.95	33,521.72	76,528.72
46	272,495.78	162,385.40	33,510.43	76,599.95	109	272,455.45	162,351.75	33,511.08	76,592.62	172	272,467.75	162,452.98	33,483.88	76,530.88
47	272,424.30	162,332.77	33,517.67	76,573.87	110	272,458.18	162,353.48	33,544.98	76,559.72	173	272,526.03	162,399.23	33,509.67	76,617.13
48	272,247.83	162,264.73	33,431.72	76,551.38	111	272,472.28	162,406.88	33,521.38	76,544.02	174	272,593.08	162,474.78	33,546.93	76,571.37
49	272,691.38	162,509.37	33,537.38	76,644.63	112	272,529.10	162,396.53	33,518.20	76,614.37	175	272,439.93	162,333.68	33,557.57	76,548.68
50	272,375.75	162,334.50	33,490.58	76,550.67	113	272,495.22	162,439.80	33,515.08	76,540.33	176	272,486.98	162,403.77	33,517.70	76,565.52
51	272,503.93	162,444.92	33,469.40	76,589.62	114	272,640.18	162,536.23	33,536.57	76,567.38	177	272,548.32	162,439.02	33,522.33	76,586.97
52	272,429.60	162,431.12	33,468.53	76,529.95	115	272,456.43	162,347.88	33,501.77	76,606.78	178	272,665.88	162,499.93	33,518.87	76,647.08
53	272,512.95	162,405.75	33,526.15	76,581.05	116	272,553.27	162,464.33	33,521.68	76,567.25	179	272,670.47	162,513.47	33,518.20	76,638.80
54	271,979.08	162,110.97	33,457.53	76,410.58	117	272,523.05	162,425.88	33,521.88	76,575.28	180	272,522.30	162,439.00	33,519.27	76,564.03
55	272,866.10	162,598.00	33,594.52	76,673.58	118	272,566.62	162,453.77	33,513.42	76,599.43	181	272,551.40	162,439.52	33,522.43	76,589.45
56	272,456.53	162,366.10	33,506.87	76,583.57	119	272,408.85	162,380.35	33,515.77	76,512.73	182	272,332.35	162,363.93	33,466.33	76,502.08
57	272,528.18	162,448.50	33,556.03	76,523.65	120	272,561.90	162,487.57	33,490.37	76,583.97	Average	272,498.87	162,410.76	33,514.61	76,573.50
58	272,411.13	162,321.10	33,533.67	76										

Sustainability – I/O Request Throughput Distribution Graph

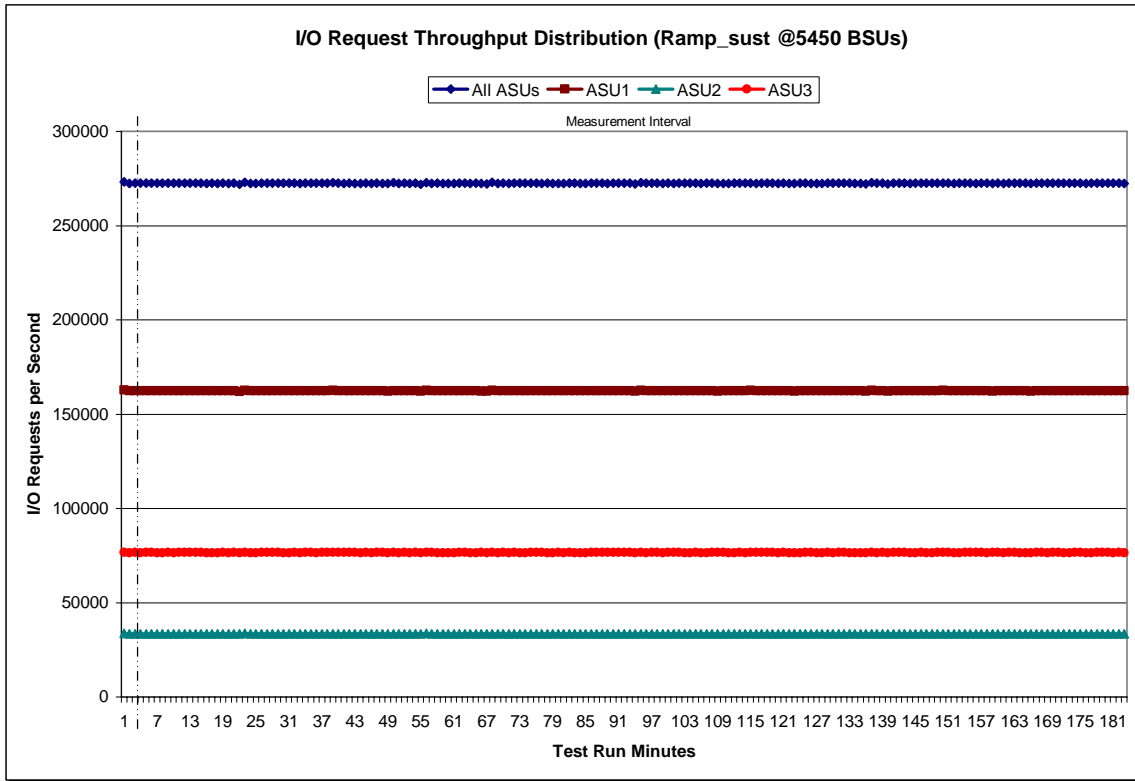

Sustainability – Average Response Time (ms) Distribution Data

		Start	Stop	Interval	Duration										
Ramp-Up/Start-Up		16:05:55	16:08:55	0-2	0:03:00										
Measurement Interval		16:08:55	19:08:57	3-182	3:00:02										
Interval	All ASUs	ASU1	ASU2	ASU3	Interval	All ASUs	ASU1	ASU2	ASU3	Interval	All ASUs	ASU1	ASU2	ASU3	
0	20.20	20.75	20.55	18.89	63	14.65	15.10	15.22	13.44	126	15.49	15.90	16.07	14.36	
1	14.78	15.09	15.30	13.91	64	14.18	14.65	14.82	12.89	127	13.29	14.04	14.10	11.35	
2	13.10	13.67	13.81	11.56	65	15.08	15.55	15.59	13.86	128	13.12	13.63	13.74	11.76	
3	13.50	14.05	14.15	12.05	66	16.79	17.47	17.41	15.05	129	11.74	12.45	12.58	9.84	
4	17.74	18.04	18.26	16.89	67	13.10	13.75	13.82	11.41	130	14.35	14.98	15.06	12.68	
5	19.28	19.43	19.74	18.74	68	12.45	13.11	13.17	10.73	131	13.55	14.06	14.23	12.18	
6	16.28	16.59	16.81	15.41	69	14.29	15.13	15.15	12.13	132	12.99	13.52	13.64	11.59	
7	16.83	17.15	17.38	15.89	70	12.06	12.67	12.82	10.44	133	13.21	13.86	13.98	11.49	
8	15.40	15.68	15.92	14.58	71	12.73	13.35	13.44	11.10	134	10.67	11.48	11.56	8.56	
9	19.88	20.61	20.47	18.07	72	14.43	14.97	15.09	13.00	135	15.37	16.15	16.08	13.41	
10	14.62	15.05	15.20	13.45	73	14.38	14.71	14.92	13.45	136	16.12	16.66	16.74	14.72	
11	11.41	12.15	12.27	9.47	74	13.99	14.66	14.72	12.23	137	12.62	13.18	13.27	11.14	
12	14.16	14.54	14.70	13.12	75	13.47	14.06	14.23	11.90	138	13.54	14.11	14.18	12.06	
13	15.64	16.57	16.43	13.33	76	16.61	17.09	17.25	15.31	139	17.66	18.26	18.33	16.11	
14	13.77	14.32	14.44	12.31	77	13.40	13.89	14.01	12.07	140	13.39	14.07	14.14	11.60	
15	15.64	16.60	16.60	13.20	78	15.82	16.51	16.48	14.05	141	11.32	11.96	12.09	9.63	
16	13.65	14.11	14.21	12.43	79	17.46	18.10	18.08	15.84	142	14.65	15.21	15.30	13.16	
17	15.83	16.18	16.36	14.85	80	14.03	14.52	14.73	12.69	143	15.02	15.50	15.69	13.71	
18	16.78	17.43	17.50	15.09	81	12.40	13.26	13.30	10.18	144	13.15	13.66	13.88	11.77	
19	19.84	20.40	20.40	18.41	82	14.19	14.71	14.84	12.83	145	12.65	13.24	13.33	11.12	
20	17.84	17.88	18.10	17.62	83	16.53	17.04	17.14	15.19	146	12.09	12.71	12.83	10.46	
21	11.67	12.64	12.68	9.18	84	14.37	14.88	14.98	13.02	147	12.23	12.84	12.97	10.63	
22	13.35	13.89	14.05	11.90	85	12.33	12.98	13.14	10.61	148	14.57	15.27	15.35	12.74	
23	19.44	19.81	19.79	18.49	86	16.37	17.07	16.99	14.61	149	11.87	12.77	12.81	9.56	
24	12.64	13.17	13.31	11.23	87	14.11	14.66	14.79	12.65	150	11.51	12.21	12.36	9.64	
25	14.04	14.68	14.71	12.41	88	12.43	13.11	13.17	10.66	151	14.60	14.91	15.16	13.71	
26	13.30	13.78	13.93	12.02	89	14.21	14.64	14.82	13.03	152	11.81	12.45	12.58	10.11	
27	13.75	14.51	14.50	11.80	90	15.54	16.56	16.44	12.99	153	13.94	14.55	14.65	12.33	
28	16.92	17.05	17.33	16.48	91	13.35	14.04	14.08	11.55	154	12.51	13.18	13.25	10.76	
29	13.28	13.77	13.95	11.94	92	15.89	16.29	16.43	14.82	155	16.98	17.65	17.62	15.28	
30	13.14	13.66	13.78	11.77	93	15.23	15.81	15.91	13.72	156	10.34	11.18	11.27	8.17	
31	14.77	15.45	15.50	13.00	94	15.31	15.77	15.85	14.10	157	12.62	13.46	13.49	10.45	
32	14.46	15.23	15.22	12.48	95	13.07	13.59	13.75	11.66	158	14.09	14.50	14.67	12.95	
33	16.63	17.21	17.37	15.08	96	12.18	12.87	12.99	10.37	159	11.16	11.91	11.98	9.22	
34	12.29	13.10	13.19	10.18	97	16.88	17.45	17.54	15.37	160	13.27	13.78	14.00	11.88	
35	14.39	15.09	15.24	12.52	98	14.33	14.75	14.93	13.19	161	12.68	13.23	13.40	11.21	
36	13.53	14.00	14.14	12.26	99	12.52	13.16	13.29	10.84	162	12.89	13.42	13.63	11.43	
37	13.76	14.58	14.54	11.69	100	11.97	12.60	12.69	10.30	163	13.21	13.81	13.91	11.64	
38	14.62	15.28	15.30	12.93	101	14.09	14.57	14.73	12.78	164	13.98	14.83	14.87	11.77	
39	11.72	12.45	12.54	9.81	102	11.39	12.10	12.20	9.52	165	14.65	15.44	15.42	12.65	
40	13.40	13.99	14.11	11.85	103	13.30	13.82	13.97	11.93	166	10.42	11.30	11.38	8.15	
41	13.01	13.52	13.64	11.64	104	11.23	11.98	12.09	9.26	167	12.06	12.72	12.87	10.30	
42	15.33	15.64	15.84	14.44	105	12.87	13.52	13.68	11.14	168	11.92	12.55	12.71	10.26	
43	13.97	14.57	14.69	12.36	106	15.09	15.72	15.81	13.43	169	12.95	13.75	13.75	10.89	
44	13.04	13.53	13.71	11.69	107	13.33	13.93	14.10	11.74	170	11.24	11.93	12.02	9.43	
45	15.65	16.35	16.36	13.85	108	12.89	13.44	13.59	11.40	171	13.35	13.87	14.01	11.94	
46	14.55	14.89	15.04	13.62	109	11.46	12.21	12.22	9.54	172	13.65	14.30	14.37	11.94	
47	14.34	14.86	14.93	12.97	110	12.39	13.03	13.11	10.73	173	11.91	12.66	12.77	9.94	
48	26.48	27.34	27.15	24.37	111	14.01	14.40	14.59	12.93	174	11.69	12.40	12.49	9.83	
49	13.06	13.70	13.77	11.40	112	11.64	12.36	12.43	9.76	175	12.83	13.38	13.55	11.36	
50	14.36	15.01	15.08	12.66	113	12.69	13.23	13.38	11.25	176	12.87	13.48	13.61	11.26	
51	14.25	14.85	14.94	12.69	114	14.72	15.09	15.27	13.68	177	14.78	15.35	15.43	13.30	
52	19.22	20.01	19.84	17.26	115	15.79	16.31	16.41	14.41	178	15.85	16.52	16.50	14.16	
53	13.79	14.35	14.44	12.32	116	13.56	14.18	14.25	11.96	179	13.14	13.77	13.82	11.49	
54	14.86	15.58	15.58	13.01	117	13.27	13.89	14.00	11.62	180	15.24	15.78	15.87	13.82	
55	15.25	16.07	15.96	13.21	118	13.90	14.31	14.45	12.77	181	13.44	13.92	14.02	12.16	
56	11.35	12.11	12.21	9.37	119	11.65	12.38	12.50	9.74	182	12.65	13.26	13.35	11.05	
57	19.73	20.42	20.48	17.94	120	11.77	12.45	12.57	9.97	Average	14.01	14.62	14.71	12.43	
58	13.98	14.49	14.66	12.61	121	11.65	12.38	12.52	9.74						
59	12.90	13.48	13.62	11.33	122	16.15	16.95	16.92	14.12						
60	14.34	14.72	14.92	13.26	123	13.04	13.88	13.91	10.86						
61	14.32	15.00	15.00	12.61	124	10.73	11.48	11.57	8.77						
62	11.35	12.04	12.12	9.54	125	14.42	14.96	15.06	12.98						

Sustainability – Average Response Time (ms) Distribution Graph

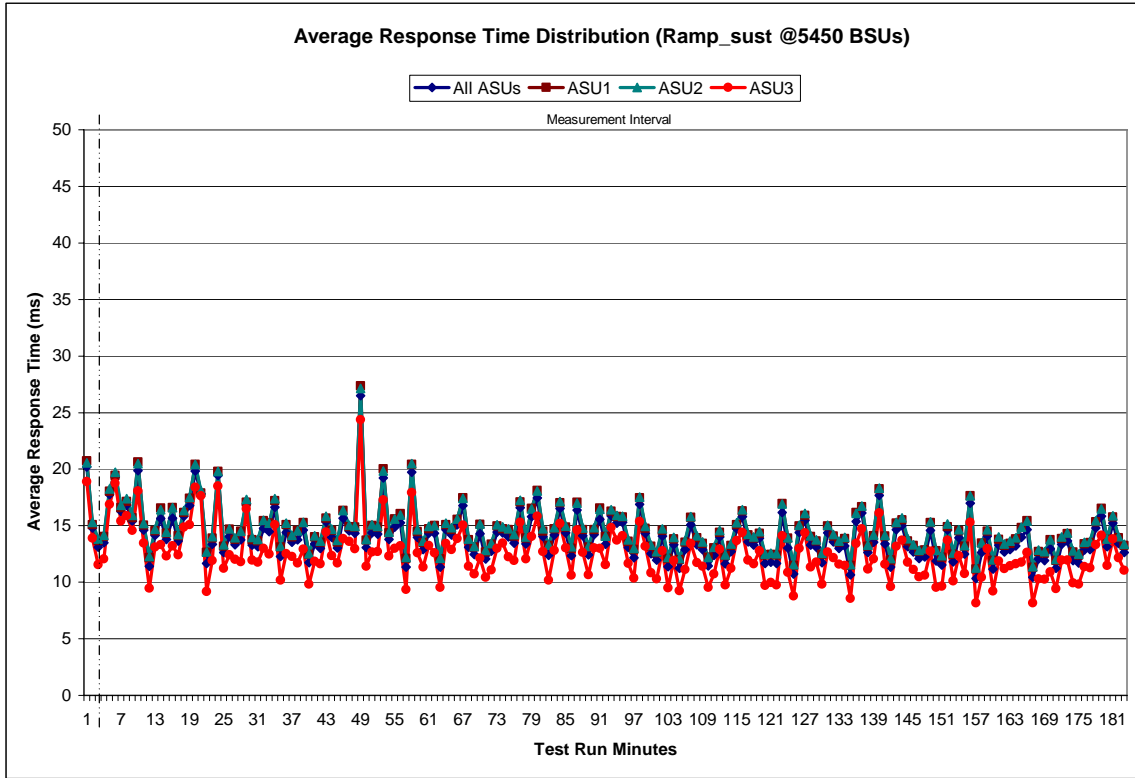

Sustainability – Response Time Frequency Distribution Data

Response Time (ms)	0-0.25	>0.25-0.5	>0.5-0.75	>0.75-1.0	>1.0-1.25	>1.25-1.5	>1.5-1.75	>1.75-2.0
Read	2,530,186	4,818,838	3,361,193	2,380,524	1,889,544	1,775,375	1,963,910	2,348,924
Write	1,054	1,312,617	5,937,428	11,550,343	17,378,668	23,040,464	28,389,186	33,338,309
All ASUs	2,531,240	6,131,455	9,298,621	13,930,867	19,268,212	24,815,839	30,353,096	35,687,233
ASU1	2,362,341	5,206,024	6,120,833	7,839,090	10,051,029	12,506,082	15,062,826	17,585,770
ASU2	168,642	483,805	924,080	1,486,535	2,107,229	2,745,162	3,393,522	4,030,133
ASU3	257	441,626	2,253,708	4,605,242	7,109,954	9,564,595	11,896,748	14,071,330

Response Time (ms)	>2.0-2.5	>2.5-3.0	>3.0-3.5	>3.5-4.0	>4.0-4.5	>4.5-5.0	>5.0-6.0	>6.0-7.0
Read	6,107,005	7,702,606	8,586,783	9,293,232	11,124,245	15,266,885	51,757,710	80,653,954
Write	81,533,063	105,907,395	136,594,229	164,714,786	177,707,958	171,741,279	272,118,525	160,048,018
All ASUs	87,640,068	113,610,001	145,181,012	174,008,018	188,832,203	187,008,164	323,876,235	240,701,972
ASU1	43,028,832	55,520,162	70,259,723	83,097,741	89,310,457	88,614,857	159,697,408	133,209,472
ASU2	10,007,084	13,031,834	16,507,248	19,430,528	20,643,286	20,057,152	34,318,334	26,070,817
ASU3	34,604,152	45,058,005	58,414,041	71,479,749	78,878,460	78,336,155	129,860,493	81,421,683

Response Time (ms)	>7.0-8.0	>8.0-9.0	>9.0-10.0	>10.0-15.0	>15.0-20.0	>20.0-25.0	>25.0-30.0	>30.0
Read	95,978,775	93,858,312	82,014,939	305,413,024	144,313,811	77,273,744	44,812,246	105,018,027
Write	83,627,641	45,115,828	27,150,865	59,930,363	27,997,987	17,922,178	14,803,401	114,878,435
All ASUs	179,606,416	138,974,140	109,165,804	365,343,387	172,311,798	95,195,922	59,615,647	219,896,462
ASU1	114,247,325	97,385,451	80,369,529	281,163,277	131,667,734	71,677,903	43,427,845	134,622,095
ASU2	20,702,755	17,102,627	14,171,856	53,114,680	27,082,035	15,232,750	9,434,132	29,711,073
ASU3	44,656,336	24,486,062	14,624,419	31,065,430	13,562,029	8,285,269	6,753,670	55,563,294

Sustainability – Response Time Frequency Distribution Graph

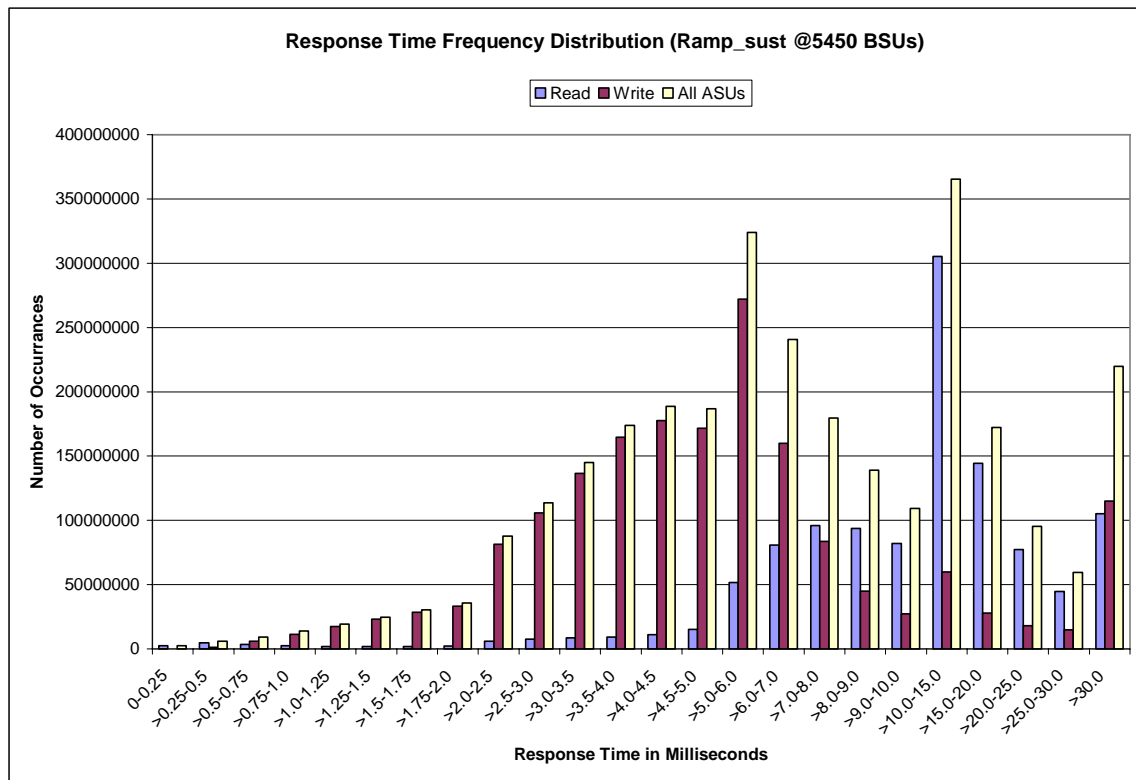

Sustainability – Measured Intensity Multiplier and Coefficient of Variation

	ASU1-1	ASU1-2	ASU1-3	ASU1-4	ASU2-1	ASU2-2	ASU2-3	ASU3-1
IM	0.0350	0.2810	0.0700	0.2100	0.0180	0.0700	0.0350	0.2810
MIM	0.0350	0.2810	0.0700	0.2100	0.0180	0.0700	0.0350	0.2810
COV	0.001	0.000	0.001	0.000	0.002	0.001	0.001	0.000

Clause 3.4.3

IM – Intensity Multiplier: The ratio of I/Os for each I/O stream relative to the total I/Os for all I/O streams (ASU1-1 – ASU3-1) as required by the benchmark specification.

Clauses 5.1.0 and 5.3.13.2

MIM – Measured Intensity Multiplier: The Measured Intensity Multiplier represents the ratio of measured I/Os for each I/O stream relative to the total I/Os measured for all I/O streams (ASU1-1 – ASU3-1). This value may differ from the corresponding Expected Intensity Multiplier by no more than 5%.

Clause 5.3.13.3

COV – Coefficient of Variation: This measure of variation for the Measured Intensity Multiplier cannot exceed 0.2.

Primary Metrics Test – IOPS Test Phase

Clause 5.4.2.2

The IOPS Test Phase consists of one Test Run at the 100% load point with a Measurement Interval of ten (10) minutes. The IOPS Test Phase immediately follows the Sustainability Test Phase without any interruption or manual intervention.

The IOPS Test Run generates the SPC-1 IOPS™ primary metric, which is computed as the I/O Request Throughput for the Measurement Interval of the IOPS Test Run.

The Average Response Time is computed for the IOPS Test Run and cannot exceed 30 milliseconds. If the Average Response Time exceeds the 30 millisecond constraint, the measurement is invalid.

Clause 9.2.4.7.2

For the IOPS Test Phase the FDR shall contain:

- 1. I/O Request Throughput Distribution (data and graph).*
- 2. A Response Time Frequency Distribution.*
- 3. An Average Response Time Distribution.*
- 4. The human readable Test Run Results File produced by the Workload Generator.*
- 5. A listing or screen image of all input parameters supplied to the Workload Generator.*
- 6. The total number of I/O Requests completed in the Measurement Interval as well as the number of I/O Requests with a Response Time less than or equal to 30 milliseconds and the number of I/O Requests with a Response Time greater than 30 milliseconds.*

SPC-1 Workload Generator Input Parameters

The SPC-1 Workload Generator input parameters for the Sustainability, IOPS, Response Time Ramp, Repeatability, and Persistence Test Runs are documented in “Appendix E: SPC-1 Workload Generator Input Parameters” on Page 69.

IOPS Test Results File

A link to the test results file generated from the IOPS Test Run is listed below.

[IOPS Test Results File](#)

IOPS Test Run – I/O Request Throughput Distribution Data

5450 BSUs	Start	Stop	Interval	Duration
<i>Start-Up/Ramp-Up</i>	19:11:32	19:14:33	0-2	0:03:01
<i>Measurement Interval</i>	19:14:33	19:24:34	3-12	0:10:01
60 second intervals	All ASUs	ASU1	ASU2	ASU3
0	272,678.75	162,485.03	33,551.60	76,642.12
1	272,514.22	162,387.57	33,547.62	76,579.03
2	272,530.77	162,430.88	33,489.63	76,610.25
3	272,404.60	162,337.07	33,520.20	76,547.33
4	272,559.40	162,444.07	33,490.43	76,624.90
5	272,588.98	162,482.40	33,482.48	76,624.10
6	272,106.22	162,170.63	33,485.95	76,449.63
7	273,002.00	162,717.75	33,561.67	76,722.58
8	272,435.88	162,372.92	33,498.62	76,564.35
9	272,430.42	162,429.25	33,458.50	76,542.67
10	272,544.70	162,417.10	33,521.33	76,606.27
11	272,492.45	162,387.78	33,508.02	76,596.65
12	272,487.20	162,400.35	33,491.53	76,595.32
Average	272,505.19	162,415.93	33,501.87	76,587.38

IOPS Test Run – I/O Request Throughput Distribution Graph

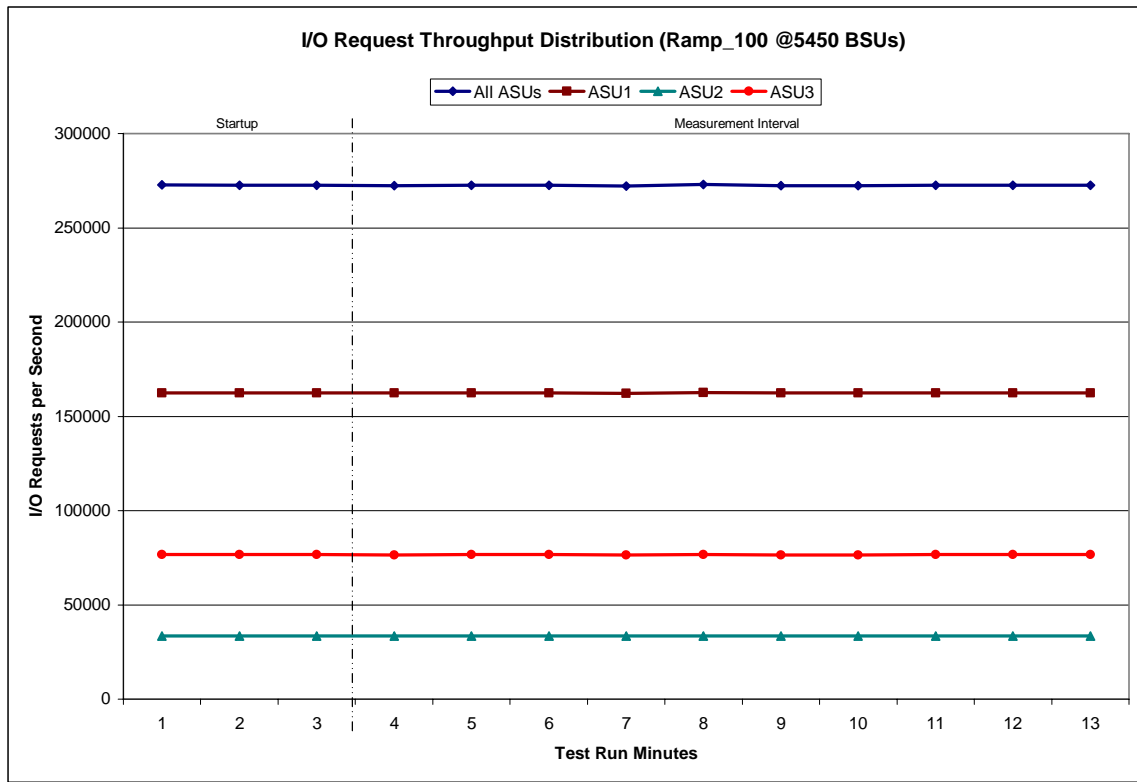

IOPS Test Run – Average Response Time (ms) Distribution Data

5450 BSUs	Start	Stop	Interval	Duration
<i>Start-Up/Ramp-Up</i>	19:11:32	19:14:33	0-2	0:03:01
<i>Measurement Interval</i>	19:14:33	19:24:34	3-12	0:10:01
60 second intervals	All ASUs	ASU1	ASU2	ASU3
0	18.48	18.65	18.55	18.10
1	14.51	14.92	15.10	13.40
2	15.85	16.19	16.44	14.87
3	12.62	13.27	13.42	10.87
4	15.93	16.69	16.69	13.99
5	13.07	13.82	13.87	11.11
6	14.23	14.80	14.97	12.70
7	19.13	19.71	19.65	17.65
8	12.22	12.86	13.02	10.53
9	11.90	12.61	12.69	10.05
10	16.35	16.98	16.98	14.73
11	13.28	13.90	14.07	11.60
12	14.28	14.92	15.00	12.61
Average	14.30	14.96	15.04	12.58

IOPS Test Run – Average Response Time (ms) Distribution Graph

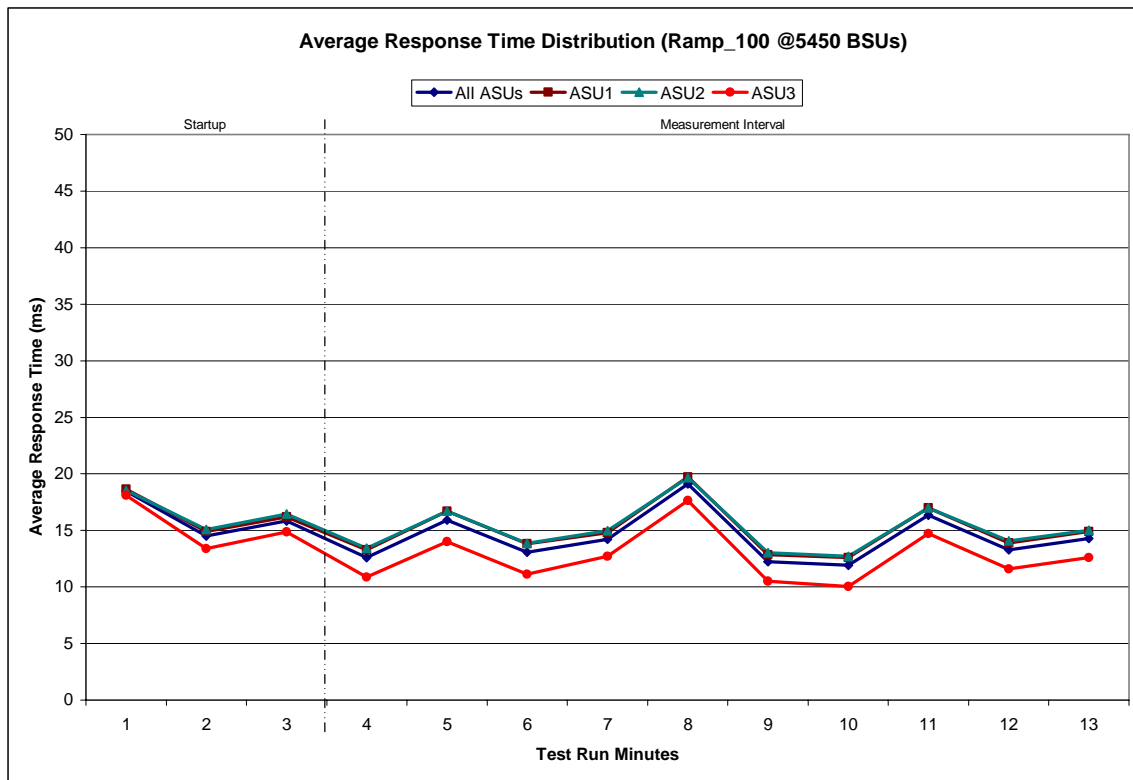

IOPS Test Run – Response Time Frequency Distribution Data

Response Time (ms)	0-0.25	>0.25-0.5	>0.5-0.75	>0.75-1.0	>1.0-1.25	>1.25-1.5	>1.5-1.75	>1.75-2.0
Read	153409	289,345	200,308	143,569	113,834	106,949	116,355	136,905
Write	22	69,514	328,143	650,317	985,851	1,309,854	1,617,550	1,908,105
All ASUs	153431	358,859	528,451	793,886	1,099,685	1,416,803	1,733,905	2,045,010
ASU1	143843	308,540	352,276	450,766	576,657	715,607	861,102	1,008,517
ASU2	9581	26,784	51,264	83,319	119,980	156,273	192,964	229,843
ASU3	7	23,535	124,911	259,801	403,048	544,923	679,839	806,650
Response Time (ms)	>2.0-2.5	>2.5-3.0	>3.0-3.5	>3.5-4.0	>4.0-4.5	>4.5-5.0	>5.0-6.0	>6.0-7.0
Read	348,311	434,523	478,581	513,798	610,680	835,443	2,821,325	4,404,011
Write	4,682,603	6,073,226	7,780,577	9,261,919	9,851,117	9,394,902	14,712,135	8,586,406
All ASUs	5,030,914	6,507,749	8,259,158	9,775,717	10,461,797	10,230,345	17,533,460	12,990,417
ASU1	2,467,817	3,175,603	3,986,607	4,660,173	4,936,919	4,835,361	8,640,763	7,204,500
ASU2	571,005	742,747	934,616	1,087,576	1,140,124	1,095,300	1,854,671	1,408,114
ASU3	1,992,092	2,589,399	3,337,935	4,027,968	4,384,754	4,299,684	7,038,026	4,377,803
Response Time (ms)	>7.0-8.0	>8.0-9.0	>9.0-10.0	>10.0-15.0	>15.0-20.0	>20.0-25.0	>25.0-30.0	>30.0
Read	5,261,373	5,163,448	4,530,954	16,818,659	8,028,951	4,343,927	2,540,788	6,050,416
Write	4,485,102	2,431,457	1,477,198	3,315,117	1,616,461	1,058,408	891,590	6,564,785
All ASUs	9,746,475	7,594,905	6,008,152	20,133,776	9,645,412	5,402,335	3,432,378	12,615,201
ASU1	6,221,791	5,337,424	4,431,946	15,492,220	7,354,425	4,050,482	2,488,713	7,744,725
ASU2	1,127,990	937,511	782,762	2,931,901	1,512,486	862,351	538,571	1,702,813
ASU3	2,396,694	1,319,970	793,444	1,709,655	778,501	489,502	405,094	3,167,663

IOPS Test Run –Response Time Frequency Distribution Graph

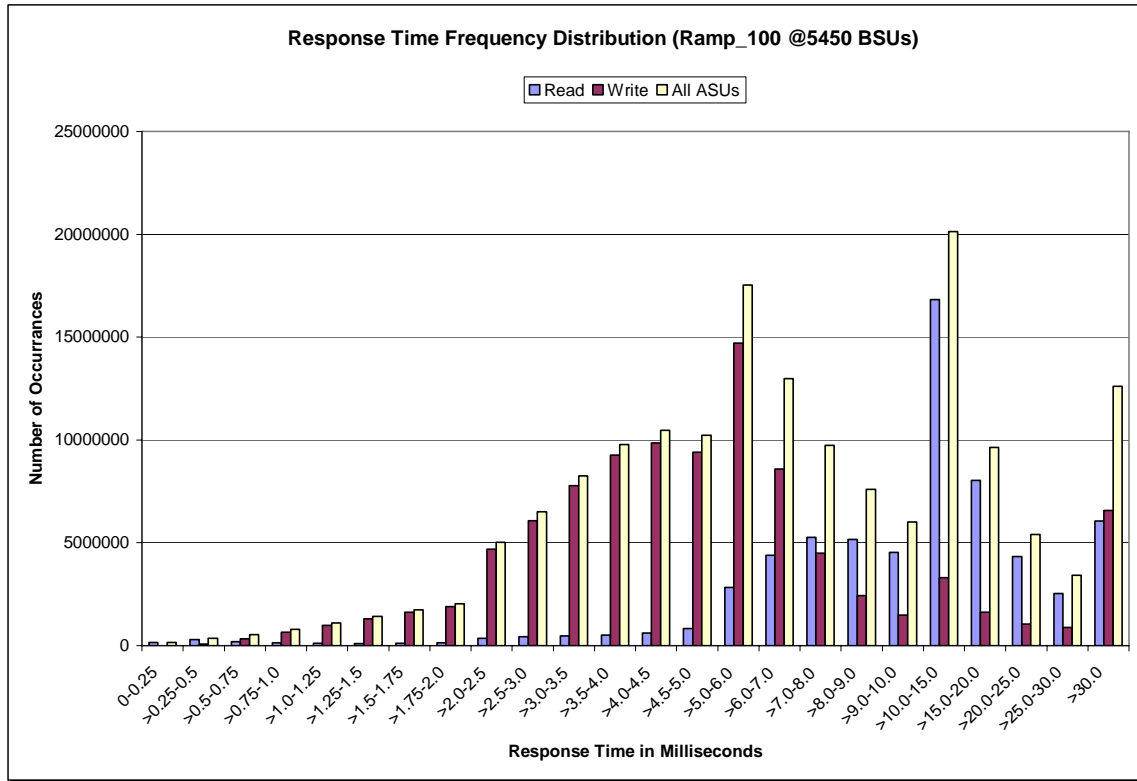

IOPS Test Run – I/O Request Information

I/O Requests Completed in the Measurement Interval	I/O Requests Completed with Response Time = or < 30 ms	I/O Requests Completed with Response Time > 30 ms
163,499,221	150,883,020	12,615,201

IOPS Test Run – Measured Intensity Multiplier and Coefficient of Variation

	ASU1-1	ASU1-2	ASU1-3	ASU1-4	ASU2-1	ASU2-2	ASU2-3	ASU3-1
<i>IM</i>	0.0350	0.2810	0.0700	0.2100	0.0180	0.0700	0.0350	0.2810
MIM	0.0350	0.2810	0.0700	0.2100	0.0180	0.0700	0.0350	0.2810
COV	0.001	0.000	0.001	0.000	0.002	0.001	0.002	0.000

Clause 3.4.3

IM – Intensity Multiplier: The ratio of I/Os for each I/O stream relative to the total I/Os for all I/O streams (ASU1-1 – ASU3-1) as required by the benchmark specification.

Clauses 5.1.0 and 5.3.13.2

MIM – Measured Intensity Multiplier: The Measured Intensity Multiplier represents the ratio of measured I/Os for each I/O stream relative to the total I/Os measured for all I/O streams (ASU1-1 – ASU3-1). This value may differ from the corresponding Expected Intensity Multiplier by no more than 5%.

Clause 5.3.13.3

COV – Coefficient of Variation: This measure of variation for the Measured Intensity Multiplier cannot exceed 0.2.

Primary Metrics Test – Response Time Ramp Test Phase

Clause 5.4.2.3

The Response Time Ramp Test Phase consists of five Test Runs, one each at 95%, 90%, 80%, 50%, and 10% of the load point (100%) used to generate the SPC-1 IOPS™ primary metric. Each of the five Test Runs has a Measurement Interval of ten (10) minutes. The Response Time Ramp Test Phase immediately follows the IOPS Test Phase without any interruption or manual intervention.

The five Response Time Ramp Test Runs, in conjunction with the IOPS Test Run (100%), demonstrate the relationship between Average Response Time and I/O Request Throughput for the Tested Storage Configuration (TSC) as illustrated in the response time/throughput curve on page 13.

In addition, the Average Response Time measured during the 10% Test Run is the value for the SPC-1 LRT™ metric. That value represents the Average Response Time of a lightly loaded TSC.

Clause 9.2.4.7.3

The following content shall appear in the FDR for the Response Time Ramp Phase:

1. A Response Time Ramp Distribution.
2. The human readable Test Run Results File produced by the Workload Generator for each Test Run within the Response Time Ramp Test Phase.
3. For the 10% Load Level Test Run (SPC-1 LRT™ metric) an Average Response Time Distribution.
4. A listing or screen image of all input parameters supplied to the Workload Generator.

SPC-1 Workload Generator Input Parameters

The SPC-1 Workload Generator input parameters for the Sustainability, IOPS, Response Time Ramp, Repeatability, and Persistence Test Runs are documented in “Appendix E: SPC-1 Workload Generator Input Parameters” on Page 69.

Response Time Ramp Test Results File

A link to each test result file generated from each Response Time Ramp Test Run list listed below.

[95% Load Level](#)

[90% Load Level](#)

[80% Load Level](#)

[50% Load Level](#)

[10% Load Level](#)

Response Time Ramp Distribution (IOPS) Data

The five Test Runs that comprise the Response Time Ramp Phase are executed at 95%, 90%, 80%, 50%, and 10% of the Business Scaling Unit (BSU) load level used to produce the SPC-1 IOPS™ primary metric. The 100% BSU load level is included in the following Response Time Ramp data tables and graphs for completeness.

100% Load Level - 5450 BSUs					95% Load Level - 5177 BSUs				
	Start	Stop	Interval	Duration		Start	Stop	Interval	Duration
Start-Up/Ramp-Up	19:11:32	19:14:33	0-2	0:03:01	Start-Up/Ramp-Up	19:26:25	19:29:26	0-2	0:03:01
Measurement Interval	19:14:33	19:24:34	3-12	0:10:01	Measurement Interval	19:29:26	19:39:27	3-12	0:10:01
(60 second intervals)	All ASUs	ASU-1	ASU-2	ASU-3	(60 second intervals)	All ASUs	ASU-1	ASU-2	ASU-3
0	272,678.75	162,485.03	33,551.60	76,642.12	0	259,116.60	154,344.83	31,891.87	72,879.90
1	272,514.22	162,387.57	33,547.62	76,579.03	1	258,797.45	154,289.10	31,842.30	72,666.05
2	272,530.77	162,430.88	33,489.63	76,610.25	2	258,818.97	154,273.17	31,846.60	72,699.20
3	272,404.60	162,337.07	33,520.20	76,547.33	3	258,742.88	154,178.25	31,859.43	72,705.20
4	272,559.40	162,444.07	33,490.43	76,624.90	4	258,803.32	154,249.83	31,797.55	72,755.93
5	272,588.98	162,482.40	33,482.48	76,624.10	5	258,924.38	154,338.65	31,821.03	72,764.70
6	272,106.22	162,170.63	33,485.95	76,449.63	6	258,820.12	154,260.35	31,852.90	72,706.87
7	273,002.00	162,717.75	33,561.67	76,722.58	7	258,789.43	154,252.67	31,814.23	72,722.53
8	272,435.88	162,372.92	33,498.62	76,564.35	8	258,850.43	154,247.27	31,862.12	72,741.05
9	272,430.42	162,429.25	33,458.50	76,542.67	9	258,816.32	154,295.85	31,856.75	72,663.72
10	272,544.70	162,417.10	33,521.33	76,606.27	10	258,913.77	154,242.38	31,859.22	72,812.17
11	272,492.45	162,387.78	33,508.02	76,596.65	11	258,822.98	154,279.57	31,821.30	72,722.12
12	272,487.20	162,400.35	33,491.53	76,595.32	12	259,017.13	154,393.03	31,878.85	72,745.25
Average	272,505.19	162,415.93	33,501.87	76,587.38	Average	258,850.08	154,273.79	31,842.34	72,733.95
90% Load Level - 4905 BSUs					80% Load Level - 4360 BSUs				
	Start	Stop	Interval	Duration		Start	Stop	Interval	Duration
Start-Up/Ramp-Up	19:41:15	19:44:16	0-2	0:03:01	Start-Up/Ramp-Up	19:55:57	19:58:58	0-2	0:03:01
Measurement Interval	19:44:16	19:54:16	3-12	0:10:00	Measurement Interval	19:58:58	20:08:58	3-12	0:10:00
(60 second intervals)	All ASUs	ASU-1	ASU-2	ASU-3	(60 second intervals)	All ASUs	ASU-1	ASU-2	ASU-3
0	245,495.32	146,304.05	30,200.47	68,990.80	0	218,158.65	129,994.80	26,834.55	61,329.30
1	245,276.00	146,230.42	30,134.62	68,910.97	1	217,981.93	129,857.95	26,825.38	61,298.60
2	245,308.73	146,221.82	30,167.88	68,919.03	2	218,076.30	129,951.68	26,808.48	61,316.13
3	245,301.25	146,202.22	30,176.22	68,922.82	3	217,950.55	129,932.13	26,799.82	61,218.60
4	245,356.55	146,261.73	30,195.78	68,899.03	4	218,022.18	129,968.25	26,808.45	61,245.48
5	245,351.67	146,256.45	30,166.20	68,929.02	5	217,930.87	129,857.68	26,783.70	61,289.48
6	245,328.77	146,214.53	30,164.45	68,949.78	6	218,048.83	129,889.80	26,840.97	61,318.07
7	245,307.77	146,230.83	30,168.80	68,908.13	7	218,047.38	130,000.87	26,814.30	61,232.22
8	245,190.57	146,156.70	30,172.03	68,861.83	8	217,923.63	129,888.72	26,779.67	61,255.25
9	245,252.40	146,156.35	30,147.52	68,948.53	9	217,928.60	129,929.70	26,803.08	61,195.82
10	245,354.90	146,179.03	30,184.73	68,991.13	10	218,064.77	129,975.95	26,799.48	61,289.33
11	245,231.07	146,148.62	30,174.03	68,908.42	11	218,067.68	129,975.22	26,818.62	61,273.85
12	245,166.45	146,082.28	30,167.60	68,916.57	12	217,962.78	129,919.98	26,820.77	61,222.03
Average	245,284.14	146,188.88	30,171.74	68,923.53	Average	217,994.73	129,933.83	26,806.89	61,254.01
50% Load Level - 2725 BSUs					10% Load Level - 545 BSUs				
	Start	Stop	Interval	Duration		Start	Stop	Interval	Duration
Start-Up/Ramp-Up	20:10:15	20:13:16	0-2	0:03:01	Start-Up/Ramp-Up	20:24:04	20:27:05	0-2	0:03:01
Measurement Interval	20:13:16	20:23:16	3-12	0:10:00	Measurement Interval	20:27:05	20:37:05	3-12	0:10:00
(60 second intervals)	All ASUs	ASU-1	ASU-2	ASU-3	(60 second intervals)	All ASUs	ASU-1	ASU-2	ASU-3
0	136,279.30	81,204.12	16,772.02	38,303.17	0	27,216.87	16,227.13	3,340.25	7,649.48
1	136,170.60	81,182.50	16,712.15	38,275.95	1	27,261.65	16,266.98	3,345.93	7,648.73
2	136,327.17	81,260.93	16,750.17	38,316.07	2	27,243.60	16,216.93	3,346.47	7,680.20
3	136,257.08	81,256.37	16,731.38	38,269.33	3	27,242.20	16,242.38	3,348.32	7,651.50
4	136,187.47	81,136.10	16,768.20	38,283.17	4	27,266.25	16,253.82	3,351.23	7,661.20
5	136,252.48	81,204.33	16,749.25	38,298.90	5	27,297.18	16,262.48	3,356.98	7,677.72
6	136,233.15	81,153.58	16,763.47	38,316.10	6	27,205.22	16,224.47	3,332.52	7,648.23
7	136,252.57	81,187.67	16,786.80	38,278.10	7	27,289.87	16,265.07	3,356.95	7,667.85
8	136,210.90	81,143.42	16,766.55	38,300.93	8	27,241.52	16,235.15	3,344.07	7,662.30
9	136,286.20	81,216.92	16,769.72	38,299.57	9	27,244.05	16,235.53	3,356.08	7,652.43
10	136,280.85	81,202.35	16,787.87	38,290.63	10	27,249.43	16,239.60	3,360.32	7,649.52
11	136,296.32	81,226.70	16,757.78	38,311.83	11	27,261.93	16,250.32	3,345.28	7,666.33
12	136,267.80	81,262.72	16,727.38	38,277.70	12	27,239.78	16,222.35	3,359.43	7,658.00
Average	136,252.48	81,199.02	16,760.84	38,292.63	Average	27,253.74	16,243.12	3,351.12	7,659.51

Response Time Ramp Distribution (IOPS) Graph

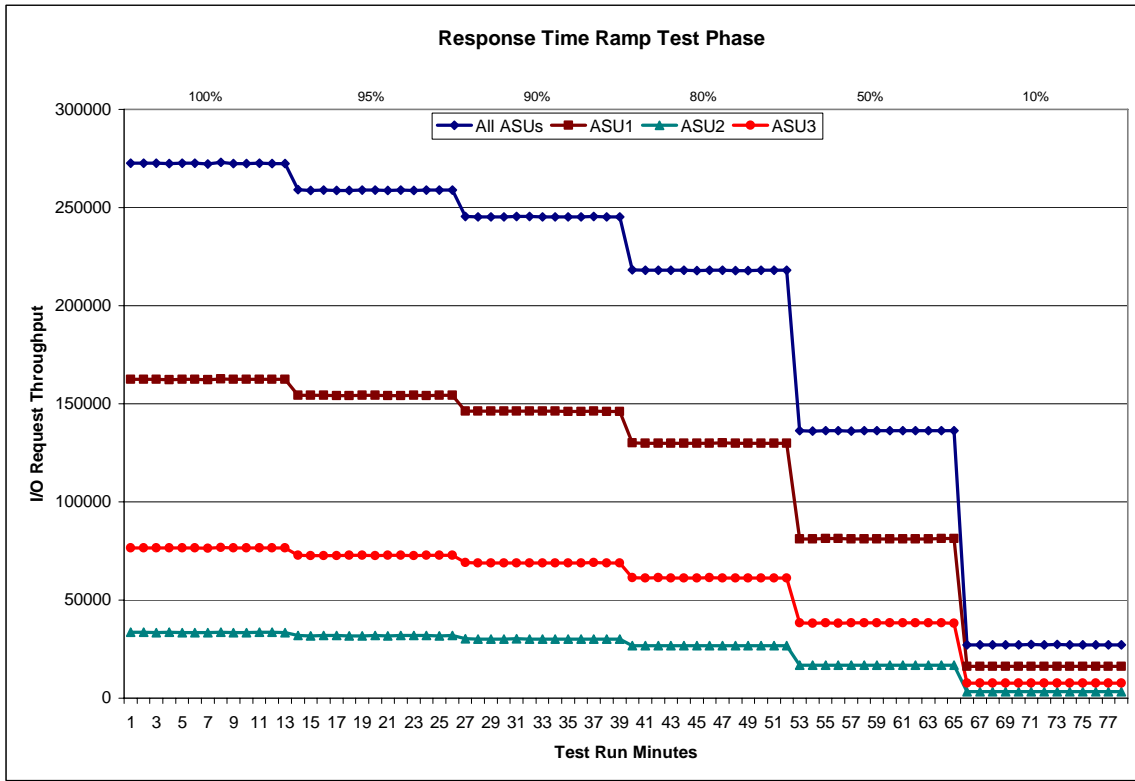

SPC-1 LRT™ Average Response Time (ms) Distribution Data

545 BSUs Start-Up/Ramp-Up Measurement Interval	Start	Stop	Interval	Duration
	20:24:04	20:27:05	0-2	0:03:01
	20:27:05	20:37:05	3-12	0:10:00
60 second intervals	All ASUs	ASU1	ASU2	ASU3
0	2.07	2.78	2.13	0.52
1	2.11	2.87	2.15	0.50
2	2.13	2.90	2.17	0.49
3	2.17	2.97	2.20	0.48
4	2.14	2.92	2.20	0.47
5	2.15	2.92	2.17	0.49
6	2.16	2.95	2.22	0.47
7	2.14	2.91	2.17	0.48
8	2.14	2.93	2.16	0.46
9	2.18	2.97	2.20	0.49
10	2.14	2.91	2.19	0.50
11	2.26	3.07	2.28	0.53
12	2.15	2.93	2.16	0.48
Average	2.16	2.95	2.19	0.49

SPC-1 LRT™ Average Response Time (ms) Distribution Graph

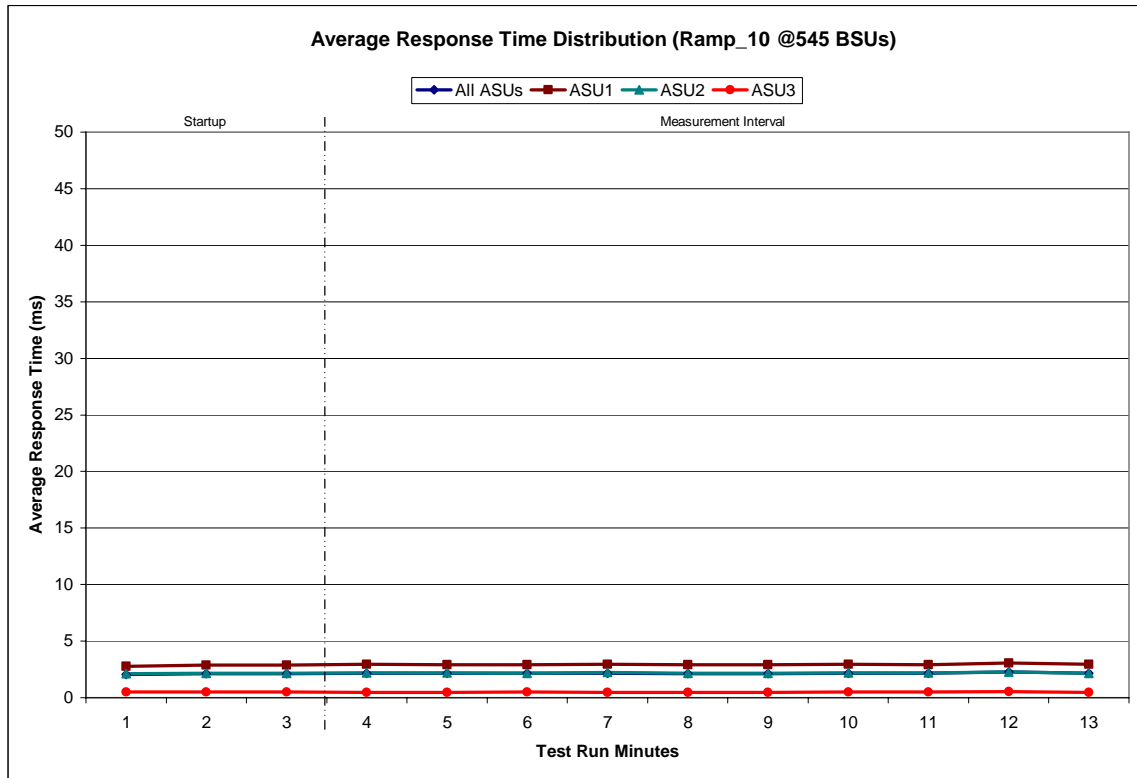

SPC-1 LRT™ (10%) – Measured Intensity Multiplier and Coefficient of Variation

	ASU1-1	ASU1-2	ASU1-3	ASU1-4	ASU2-1	ASU2-2	ASU2-3	ASU3-1
IM	0.0350	0.2810	0.0700	0.2100	0.0180	0.0700	0.0350	0.2810
MIM	0.0351	0.2810	0.0700	0.2099	0.0180	0.0700	0.0350	0.2810
COV	0.004	0.002	0.003	0.002	0.005	0.003	0.003	0.001

Clause 3.4.3

IM – Intensity Multiplier: The ratio of I/Os for each I/O stream relative to the total I/Os for all I/O streams (ASU1-1 – ASU3-1) as required by the benchmark specification.

Clauses 5.1.0 and 5.3.13.2

MIM – Measured Intensity Multiplier: The Measured Intensity Multiplier represents the ratio of measured I/Os for each I/O stream relative to the total I/Os measured for all I/O streams (ASU1-1 – ASU3-1). This value may differ from the corresponding Expected Intensity Multiplier by no more than 5%.

Clause 5.3.13.3

COV – Coefficient of Variation: This measure of variation for the Measured Intensity Multiplier cannot exceed 0.2.

Repeatability Test

Clause 5.4.5

The Repeatability Test demonstrates the repeatability and reproducibility of the SPC-1 IOPS™ primary metric and SPC-1 LRT™ metric generated in earlier Test Runs.

There are two identical Repeatability Test Phases. Each Test Phase contains two Test Runs. Each of the Test Runs will have a Measurement Interval of no less than ten (10) minutes. The two Test Runs in each Test Phase will be executed without interruption or any type of manual intervention.

The first Test Run in each Test Phase is executed at the 10% load point. The Average Response Time from each of the Test Runs is compared to the SPC-1 LRT™ metric. Each Average Response Time value must be less than the SPC-1 LRT™ metric plus 5%.

The second Test Run in each Test Phase is executed at the 100% load point. The I/O Request Throughput from the Test Runs is compared to the SPC-1 IOPS™ primary metric. Each I/O Request Throughput value must be greater than the SPC-1 IOPS™ primary metric minus 5%. In addition, the Average Response Time for each Test Run cannot exceed 30 milliseconds.

If any of the above constraints are not met, the benchmark measurement is invalid.

Clause 9.2.4.7.4

The following content shall appear in the FDR for each Test Run in the two Repeatability Test Phases:

- 1. A table containing the results of the Repeatability Test.*
- 2. An I/O Request Throughput Distribution graph and table.*
- 3. An Average Response Time Distribution graph and table.*
- 4. The human readable Test Run Results File produced by the Workload Generator.*
- 5. A listing or screen image of all input parameters supplied to the Workload Generator.*

SPC-1 Workload Generator Input Parameters

The SPC-1 Workload Generator input parameters for the Sustainability, IOPS, Response Time Ramp, Repeatability, and Persistence Test Runs are documented in “Appendix E: SPC-1 Workload Generator Input Parameters” on Page 69.

Repeatability Test Results File

The values for the SPC-1 IOPS™, SPC-1 LRT™, and the Repeatability Test measurements are listed below.

	SPC-1 IOPS™	SPC-1 LRT™
<i>Primary Metrics</i>	272,505.19	2.16
Repeatability Test Phase 1	272,480.70	2.17
Repeatability Test Phase 2	272,500.83	2.16

A link to the test result file generated from each Repeatability Test Run list is listed below.

[Repeatability Test Phase 1, Test Run 1 \(LRT\)](#)

[Repeatability Test Phase 1, Test Run 2 \(IOPS\)](#)

[Repeatability Test Phase 2, Test Run 1 \(LRT\)](#)

[Repeatability Test Phase 2, Test Run 2 \(IOPS\)](#)

Repeatability 1 LRT - I/O Request Throughput Distribution Data

545 BSUs				
	Start	Stop	Interval	Duration
<i>Start-Up/Ramp-Up</i>	20:39:07	20:42:07	0-2	0:03:00
<i>Measurement Interval</i>	20:42:07	20:52:07	3-12	0:10:00
60 second intervals	All ASUs	ASU1	ASU2	ASU3
0	27,272.95	16,259.53	3,355.87	7,657.55
1	27,232.65	16,241.52	3,352.22	7,638.92
2	27,237.23	16,225.17	3,357.83	7,654.23
3	27,257.22	16,247.17	3,347.07	7,662.98
4	27,228.03	16,237.77	3,334.25	7,656.02
5	27,245.83	16,236.98	3,358.15	7,650.70
6	27,279.92	16,242.67	3,363.23	7,674.02
7	27,254.28	16,257.77	3,340.55	7,655.97
8	27,257.53	16,270.25	3,359.28	7,628.00
9	27,264.60	16,249.12	3,348.15	7,667.33
10	27,234.17	16,255.02	3,338.57	7,640.58
11	27,217.53	16,218.85	3,357.60	7,641.08
12	27,252.55	16,242.77	3,360.93	7,648.85
Average	27,249.17	16,245.84	3,350.78	7,652.55

Repeatability 1 LRT - I/O Request Throughput Distribution Graph

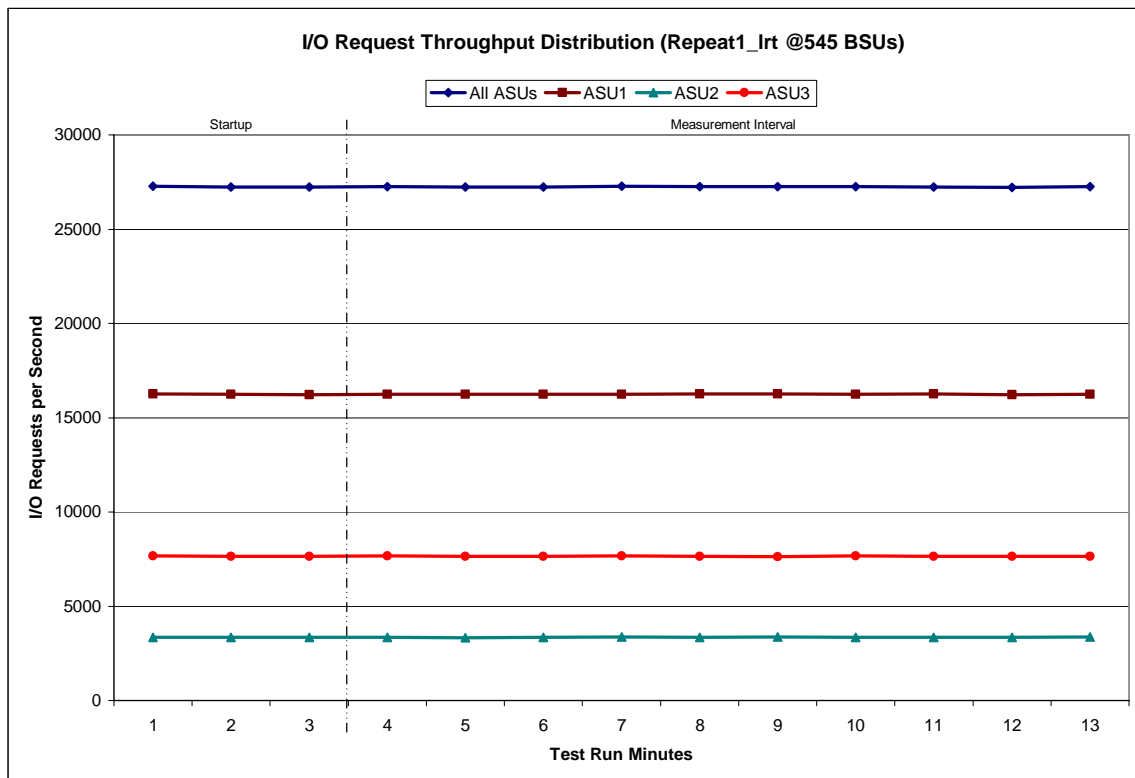

Repeatability 1 LRT –Average Response Time (ms) Distribution Data

545 BSUs	Start	Stop	Interval	Duration
<i>Start-Up/Ramp-Up</i>	20:39:07	20:42:07	0-2	0:03:00
<i>Measurement Interval</i>	20:42:07	20:52:07	3-12	0:10:00
60 second intervals	All ASUs	ASU1	ASU2	ASU3
0	2.18	2.96	2.24	0.50
1	2.10	2.85	2.14	0.49
2	2.08	2.85	2.13	0.44
3	2.14	2.93	2.17	0.48
4	2.14	2.92	2.17	0.49
5	2.17	2.97	2.19	0.47
6	2.17	2.95	2.21	0.52
7	2.16	2.93	2.21	0.50
8	2.18	2.97	2.24	0.48
9	2.17	2.97	2.23	0.46
10	2.20	3.01	2.23	0.47
11	2.21	3.02	2.25	0.47
12	2.18	2.98	2.22	0.47
Average	2.17	2.96	2.21	0.48

Repeatability 1 LRT –Average Response Time (ms) Distribution Graph

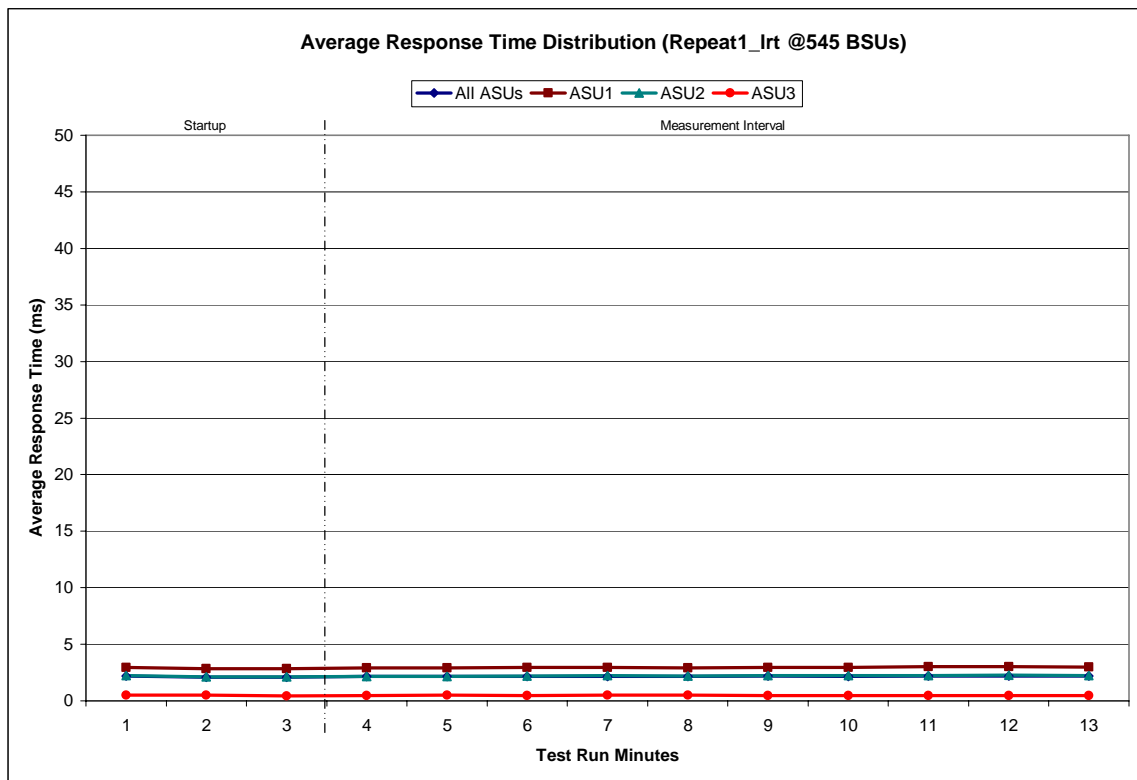

Repeatability 1 IOPS - I/O Request Throughput Distribution Data

5450 BSUs	Start	Stop	Interval	Duration
<i>Start-Up/Ramp-Up</i>	20:54:11	20:57:12	0-2	0:03:01
<i>Measurement Interval</i>	20:57:12	21:07:13	3-12	0:10:01
60 second intervals	All ASUs	ASU1	ASU2	ASU3
0	272,648.37	162,501.60	33,541.90	76,604.87
1	272,406.42	162,344.62	33,505.15	76,556.65
2	272,484.47	162,444.18	33,501.07	76,539.22
3	272,597.20	162,463.85	33,532.67	76,600.68
4	272,389.50	162,339.78	33,570.07	76,479.65
5	272,548.80	162,446.35	33,525.82	76,576.63
6	272,663.98	162,480.67	33,513.55	76,669.77
7	272,446.28	162,349.53	33,529.93	76,566.82
8	272,424.52	162,359.92	33,525.90	76,538.70
9	272,526.95	162,434.92	33,519.48	76,572.55
10	272,325.12	162,262.63	33,562.37	76,500.12
11	272,471.75	162,352.87	33,536.53	76,582.35
12	272,412.87	162,340.05	33,512.52	76,560.30
Average	272,480.70	162,383.06	33,532.88	76,564.76

Repeatability 1 IOPS - I/O Request Throughput Distribution Graph

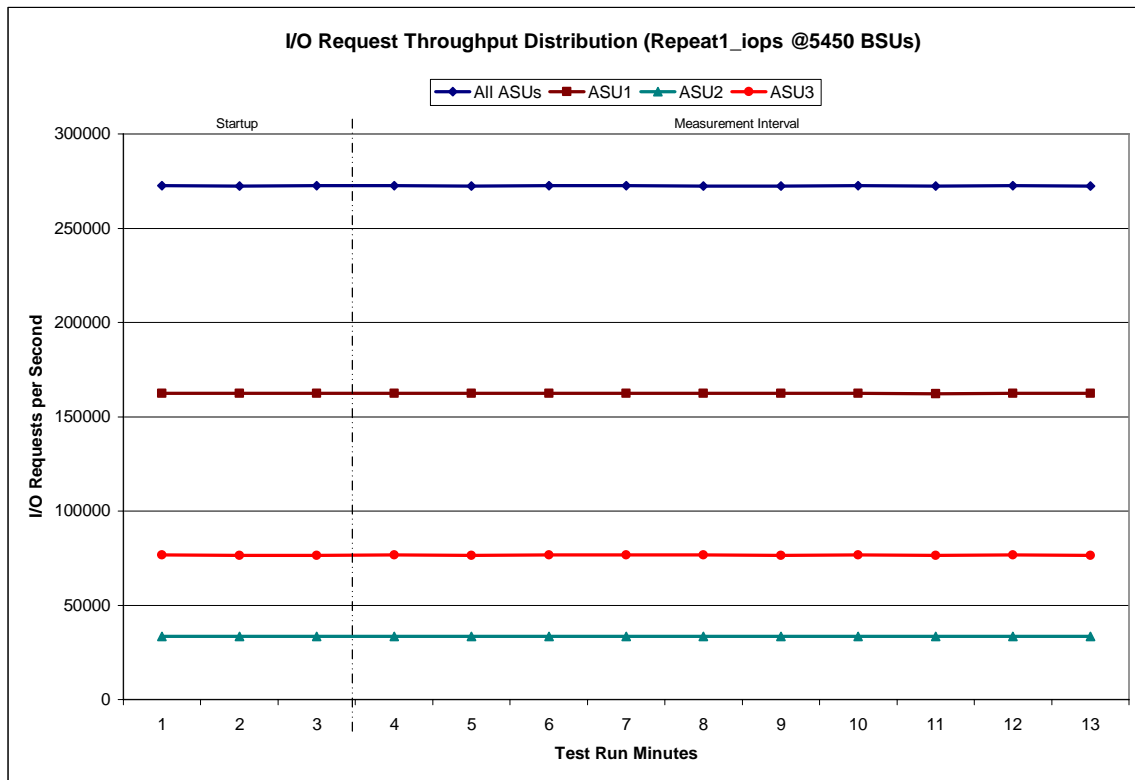

Repeatability 1 IOPS –Average Response Time (ms) Distribution Data

5450 BSUs	Start	Stop	Interval	Duration
<i>Start-Up/Ramp-Up</i>	20:54:11	20:57:12	0-2	0:03:01
<i>Measurement Interval</i>	20:57:12	21:07:13	3-12	0:10:01
60 second intervals	All ASUs	ASU1	ASU2	ASU3
0	21.66	22.17	21.66	20.57
1	14.37	15.07	15.09	12.58
2	14.34	14.90	15.05	12.83
3	14.33	14.83	15.06	12.96
4	16.18	16.99	16.96	14.11
5	16.18	16.40	16.60	15.53
6	16.05	16.62	16.78	14.50
7	12.24	12.89	13.00	10.54
8	15.52	16.01	16.21	14.19
9	12.76	13.43	13.60	10.96
10	11.12	11.92	12.03	9.04
11	13.67	14.39	14.41	11.82
12	13.18	14.02	14.06	11.03
Average	14.12	14.75	14.87	12.47

Repeatability 1 IOPS –Average Response Time (ms) Distribution Graph

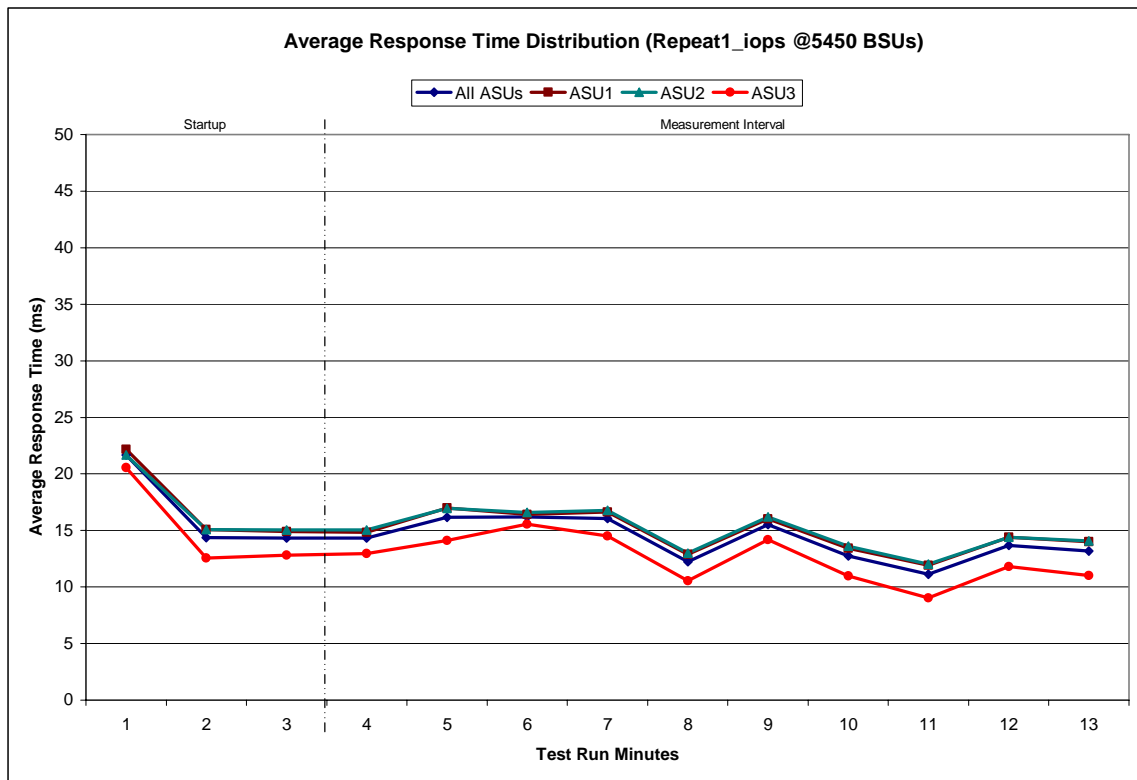

Repeatability 2 LRT - I/O Request Throughput Distribution Data

545 BSUs	Start	Stop	Interval	Duration
<i>Start-Up/Ramp-Up</i>	21:09:09	21:12:09	0-2	0:03:00
<i>Measurement Interval</i>	21:12:09	21:22:09	3-12	0:10:00
60 second intervals	All ASUs	ASU1	ASU2	ASU3
0	27,277.43	16,265.65	3,350.73	7,661.05
1	27,251.60	16,242.43	3,348.13	7,661.03
2	27,249.40	16,236.67	3,344.20	7,668.53
3	27,242.70	16,260.63	3,340.60	7,641.47
4	27,246.03	16,246.13	3,351.22	7,648.68
5	27,253.12	16,251.18	3,337.30	7,664.63
6	27,228.28	16,226.30	3,347.72	7,654.27
7	27,268.03	16,264.43	3,344.92	7,658.68
8	27,263.28	16,269.87	3,351.17	7,642.25
9	27,286.07	16,269.32	3,360.27	7,656.48
10	27,241.85	16,234.23	3,344.22	7,663.40
11	27,233.45	16,219.42	3,353.67	7,660.37
12	27,257.15	16,238.98	3,349.68	7,668.48
Average	27,252.00	16,248.05	3,348.08	7,655.87

Repeatability 2 LRT - I/O Request Throughput Distribution Graph

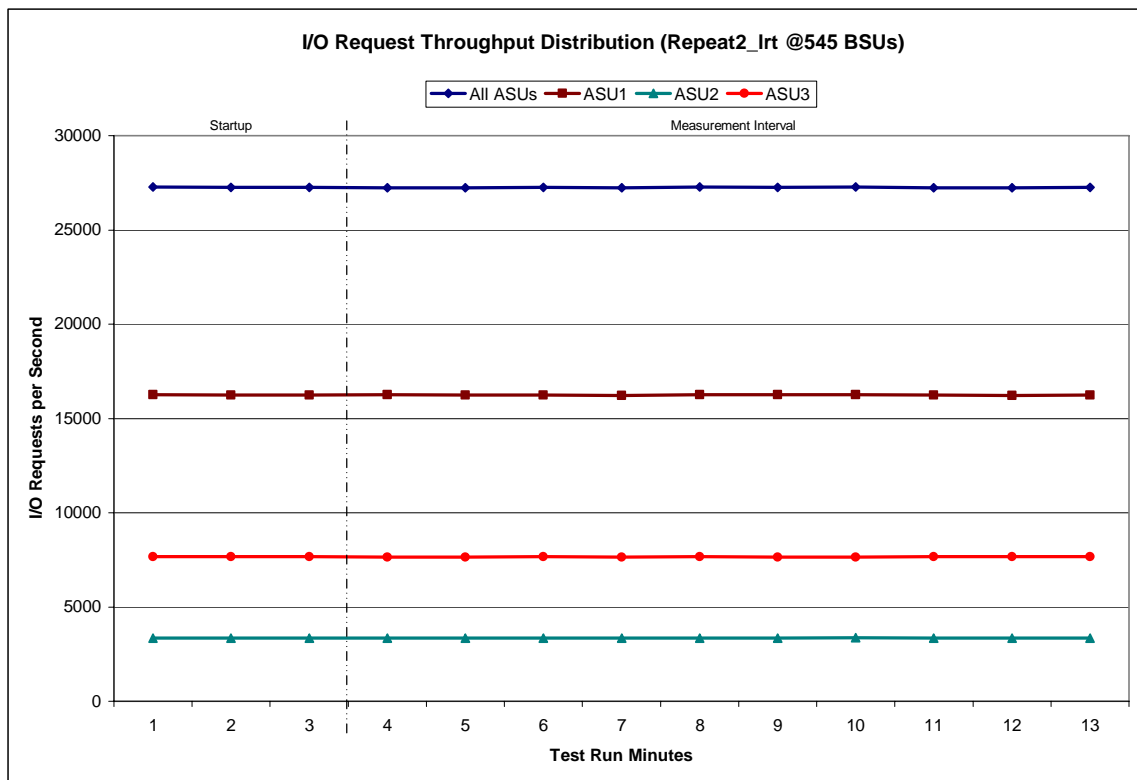

Repeatability 2 LRT –Average Response Time (ms) Distribution Data

545 BSUs	Start	Stop	Interval	Duration
<i>Start-Up/Ramp-Up</i>	21:09:09	21:12:09	0-2	0:03:00
<i>Measurement Interval</i>	21:12:09	21:22:09	3-12	0:10:00
60 second intervals	All ASUs	ASU1	ASU2	ASU3
0	1.76	2.43	1.76	0.35
1	2.38	3.30	2.39	0.41
2	2.22	3.06	2.22	0.42
3	2.12	2.92	2.14	0.42
4	2.19	3.00	2.20	0.46
5	2.19	3.01	2.22	0.45
6	2.17	2.97	2.22	0.45
7	2.16	2.94	2.19	0.49
8	2.10	2.83	2.12	0.51
9	2.14	2.90	2.18	0.50
10	2.17	2.96	2.19	0.48
11	2.09	2.85	2.13	0.47
12	2.24	3.06	2.25	0.51
Average	2.16	2.94	2.18	0.47

Repeatability 2 LRT –Average Response Time (ms) Distribution Graph

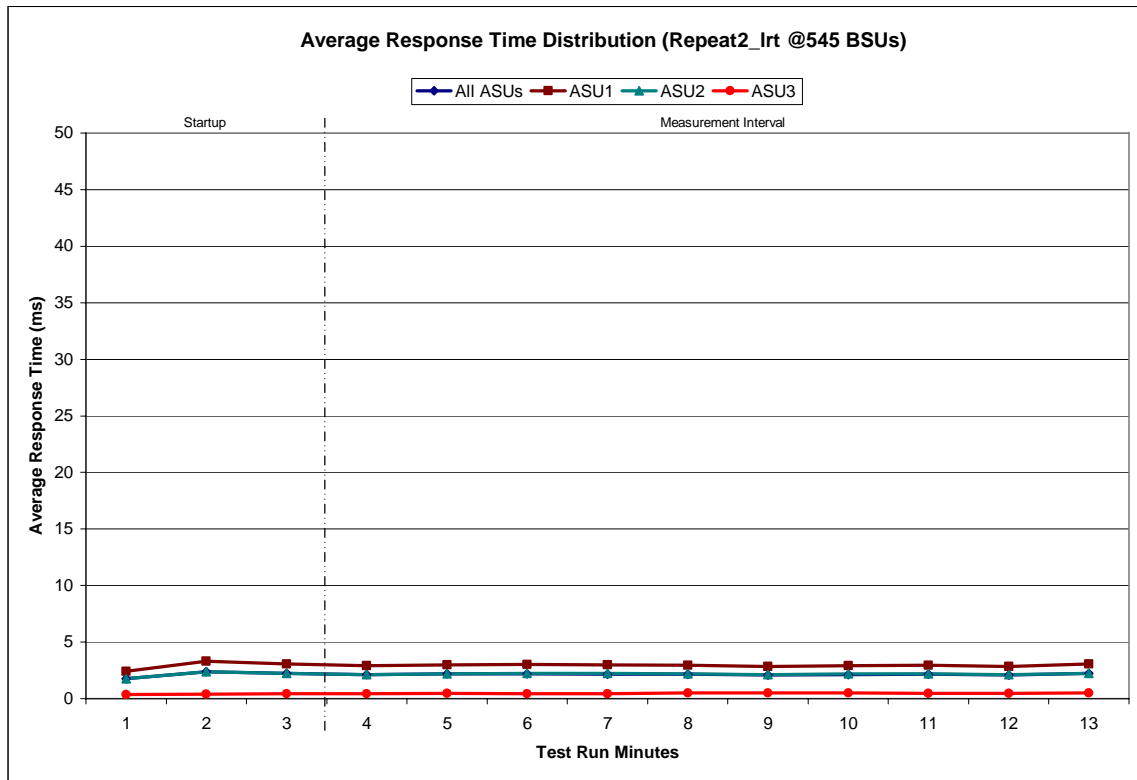

Repeatability 2 IOPS - I/O Request Throughput Distribution Data

5450 BSUs				
	Start	Stop	Interval	Duration
<i>Start-Up/Ramp-Up</i>	21:24:14	21:27:15	0-2	0:03:01
<i>Measurement Interval</i>	21:27:15	21:37:15	3-12	0:10:00
60 second intervals	All ASUs	ASU1	ASU2	ASU3
0	272,653.87	162,517.25	33,508.08	76,628.53
1	272,348.63	162,370.95	33,494.42	76,483.27
2	272,632.97	162,467.85	33,519.03	76,646.08
3	272,591.97	162,476.58	33,503.77	76,611.62
4	272,550.17	162,429.58	33,535.95	76,584.63
5	272,381.65	162,349.45	33,518.90	76,513.30
6	272,677.82	162,502.18	33,557.75	76,617.88
7	272,384.42	162,336.17	33,497.25	76,551.00
8	272,477.43	162,391.73	33,504.55	76,581.15
9	272,524.13	162,449.93	33,527.03	76,547.17
10	272,510.50	162,369.30	33,511.57	76,629.63
11	272,557.02	162,392.23	33,511.78	76,653.00
12	272,353.20	162,352.25	33,486.72	76,514.23
Average	272,500.83	162,404.94	33,515.53	76,580.36

Repeatability 2 IOPS - I/O Request Throughput Distribution Graph

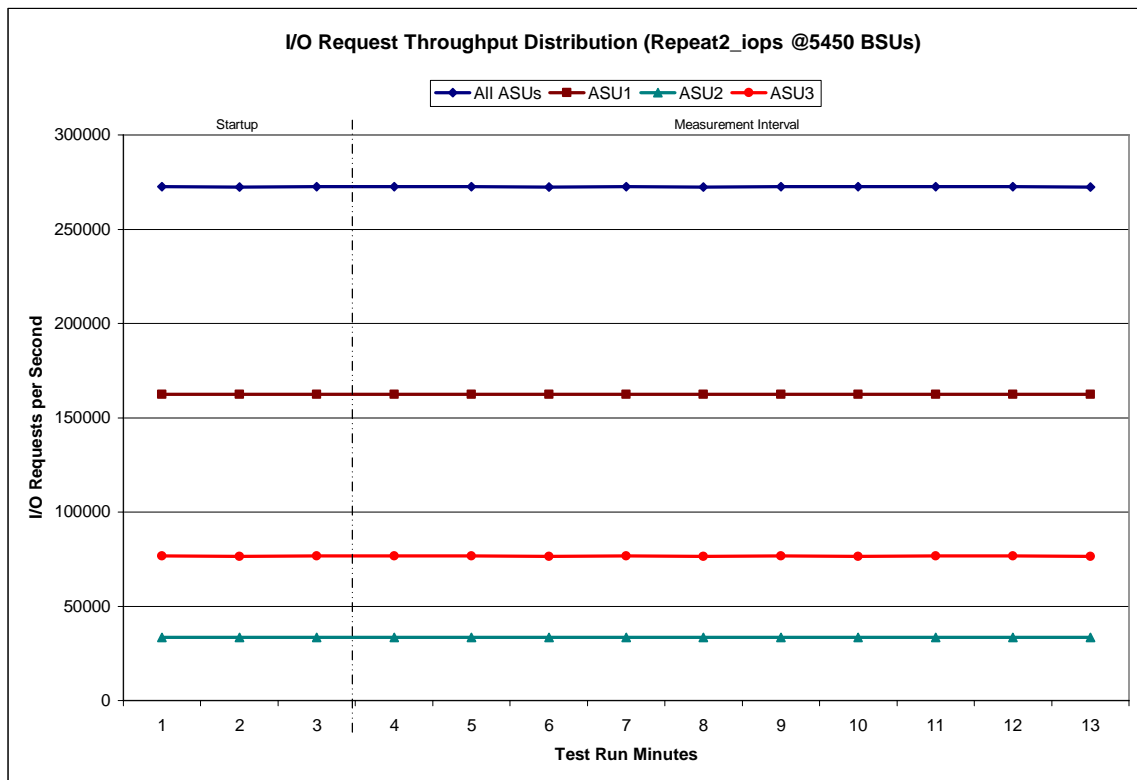

Repeatability 2 IOPS –Average Response Time (ms) Distribution Data

5450 BSUs	Start	Stop	Interval	Duration
<i>Start-Up/Ramp-Up</i>	21:24:14	21:27:15	0-2	0:03:01
<i>Measurement Interval</i>	21:27:15	21:37:15	3-12	0:10:00
60 second intervals	All ASUs	ASU1	ASU2	ASU3
0	15.98	15.80	15.96	16.37
1	12.76	13.52	13.61	10.77
2	16.21	16.80	16.86	14.69
3	14.33	15.15	15.09	12.25
4	15.04	15.47	15.63	13.88
5	11.46	12.22	12.37	9.44
6	13.65	14.23	14.42	12.08
7	11.24	12.03	12.12	9.18
8	17.74	18.37	18.36	16.14
9	12.84	13.41	13.55	11.34
10	15.91	16.65	16.70	13.99
11	12.54	13.18	13.30	10.83
12	14.65	15.29	15.45	12.94
Average	13.94	14.60	14.70	12.21

Repeatability 2 IOPS –Average Response Time (ms) Distribution Graph

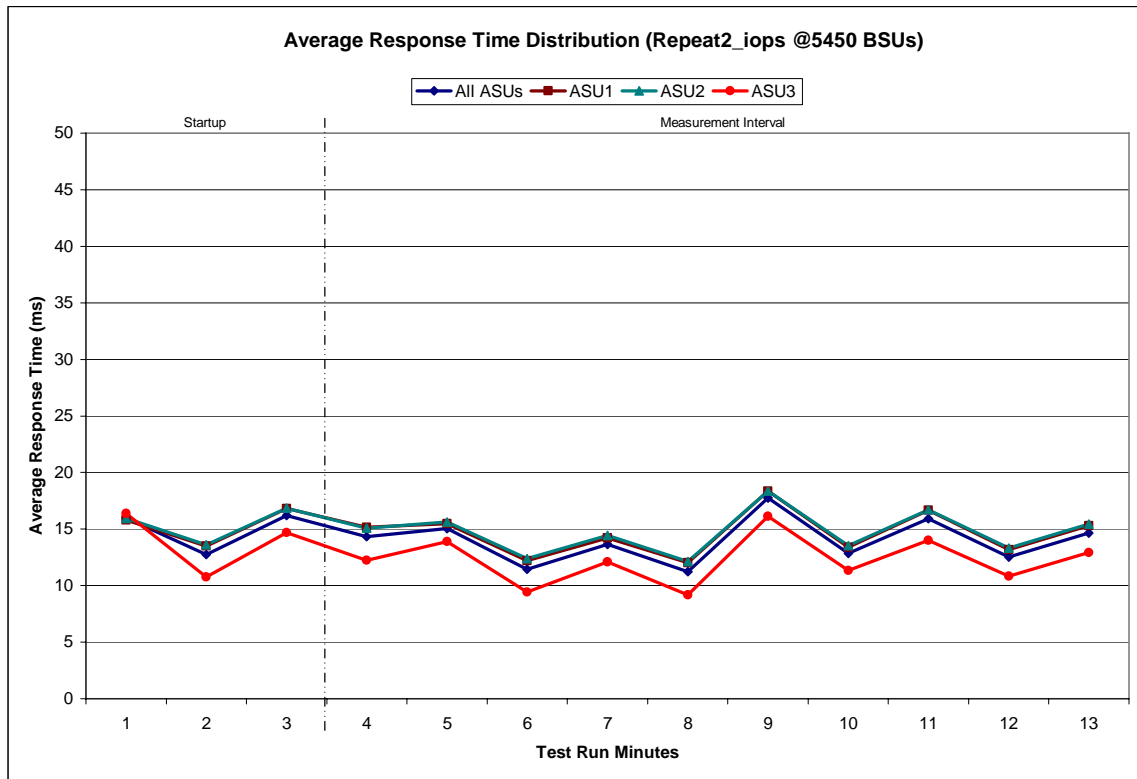

Repeatability 1 (LRT)
Measured Intensity Multiplier and Coefficient of Variation

	ASU1-1	ASU1-2	ASU1-3	ASU1-4	ASU2-1	ASU2-2	ASU2-3	ASU3-1
IM	0.0350	0.2810	0.0700	0.2100	0.0180	0.0700	0.0350	0.2810
MIM	0.0350	0.2812	0.0700	0.2100	0.0180	0.0700	0.0350	0.2808
COV	0.004	0.001	0.003	0.002	0.007	0.003	0.005	0.002

Clause 3.4.3

IM - Intensity Multiplier: The ratio of I/Os for each I/O stream relative to the total I/Os for all I/O streams (ASU1-1 – ASU3-1) as required by the benchmark specification.

Clauses 5.1.0 and 5.3.13.2

MIM - Measured Intensity Multiplier: The Measured Intensity Multiplier represents the ratio of measured I/Os for each I/O stream relative to the total I/Os measured for all I/O streams (ASU1-1 – ASU3-1). This value may differ from the corresponding Expected Intensity Multiplier by no more than 5%.

Clause 5.3.13.3

COV - Coefficient of Variation: This measure of variation for the Measured Intensity Multiplier cannot exceed 0.2.

Repeatability 1 (IOPS)
Measured Intensity Multiplier and Coefficient of Variation

	ASU1-1	ASU1-2	ASU1-3	ASU1-4	ASU2-1	ASU2-2	ASU2-3	ASU3-1
IM	0.0350	0.2810	0.0700	0.2100	0.0180	0.0700	0.0350	0.2810
MIM	0.0350	0.2810	0.0700	0.2100	0.0180	0.0700	0.0350	0.2810
COV	0.001	0.000	0.001	0.000	0.002	0.001	0.001	0.000

Repeatability 2 (LRT)
Measured Intensity Multiplier and Coefficient of Variation

	ASU1-1	ASU1-2	ASU1-3	ASU1-4	ASU2-1	ASU2-2	ASU2-3	ASU3-1
IM	0.0350	0.2810	0.0700	0.2100	0.0180	0.0700	0.0350	0.2810
MIM	0.0351	0.2810	0.0700	0.2101	0.0180	0.0699	0.0349	0.2809
COV	0.006	0.001	0.002	0.001	0.006	0.004	0.004	0.001

Repeatability 2 (IOPS)
Measured Intensity Multiplier and Coefficient of Variation

	ASU1-1	ASU1-2	ASU1-3	ASU1-4	ASU2-1	ASU2-2	ASU2-3	ASU3-1
<i>IM</i>	<i>0.0350</i>	<i>0.2810</i>	<i>0.0700</i>	<i>0.2100</i>	<i>0.0180</i>	<i>0.0700</i>	<i>0.0350</i>	<i>0.2810</i>
MIM	0.0350	0.2810	0.0700	0.2100	0.0180	0.0700	0.0350	0.2810
COV	0.002	0.000	0.001	0.000	0.002	0.001	0.001	0.000

Data Persistence Test

Clause 6

The Data Persistence Test demonstrates the Tested Storage Configuration (TSC):

- *Is capable of maintain data integrity across a power cycle.*
- *Ensures the transfer of data between Logical Volumes and host systems occurs without corruption or loss.*

The SPC-1 Workload Generator will write 16 block I/O requests at random over the total Addressable Storage Capacity of the TSC for ten (10) minutes at a minimum of 25% of the load used to generate the SPC-1 IOP™ primary metric. The bit pattern selected to be written to each block as well as the address of the block will be retained in a log file.

The Benchmark Configuration will be shutdown and restarted using a power off/power on cycle at the end of the above sequence of write operations. In addition, any caches employing battery backup must be flushed/emptied.

The SPC-1 Workload Generator will then use the above log file to verify each block written contains the correct bit pattern.

Clause 9.2.4.8

The following content shall appear in this section of the FDR:

1. *A listing or screen image of all input parameters supplied to the Workload Generator.*
2. *For the successful Data Persistence Test Run, a table illustrating key results. The content, appearance, and format of this table are specified in Table 9-12. Information displayed in this table shall be obtained from the Test Run Results File referenced below in #3.*
3. *For the successful Data Persistence Test Run, the human readable Test Run Results File produced by the Workload Generator.*

SPC-1 Workload Generator Input Parameters

The SPC-1 Workload Generator input parameters for the Sustainability, IOPS, Response Time Ramp, Repeatability, and Persistence Test Runs are documented in “Appendix E: SPC-1 Workload Generator Input Parameters” on Page 69.

Data Persistence Test Results File

A link to each test result file generated from each Data Persistence Test is listed below.

[Persistence 1 Test Results File](#)

[Persistence 2 Test Results File](#)

Data Persistence Test Results

Data Persistence Test Results	
Data Persistence Test Run Number: 1	
Total Number of Logical Blocks Written	164,133,808
Total Number of Logical Blocks Verified	118,005,488
Total Number of Logical Blocks that Failed Verification	0
Time Duration for Writing Test Logical Blocks	10 minutes
Size in Bytes of each Logical Block	512
Number of Failed I/O Requests in the process of the Test	0

In some cases the same address was the target of multiple writes, which resulted in more Logical Blocks Written than Logical Blocks Verified. In the case of multiple writes to the same address, the pattern written and verified must be associated with the last write to that address.

PRICED STORAGE CONFIGURATION AVAILABILITY DATE

Clause 9.2.4.9

The committed delivery data for general availability (Availability Date) of all products that comprise the Priced Storage Configuration must be reported. When the Priced Storage Configuration includes products or components with different availability dates, the reported Availability Date must be the date at which all components are committed to be available.

The FDR shall state: "The Priced Storage Configuration, as documented in this Full Disclosure Report will be available for shipment to customers on MMMM DD, YYYY." Where Priced Storage Configuration is the TSC Configuration Name as described in Clause 9.2.4.3.3 and MMMM is the alphanumeric month, DD is the numeric day, and YYYY is the numeric year of the date that the Priced Storage Configuration, as documented, is available for shipment to customers as described above.

The IBM Total Storage SAN Volume Controller 4.2, as documented in this Full Disclosure Report is currently available for customer purchase and shipment.

PRICING INFORMATION

Clause 9.2.4.11

A statement of the respective calculations for pricing must be included.

Clause 9.2.4.11.3

A list of all differences between the Tested Storage Configuration (TSC) and Priced Storage Configuration must be included.

Pricing information may found in the Tested Storage Configuration Pricing section on page 14. A list of all differences between the Tested Storage Configuration (TSC) and Priced Storage Configuration may be found in the Executive Summary portion of this document on page 14.

ANOMALIES OR IRREGULARITIES

Clause 9.2.4.10

The FDR shall include a clear and complete description of any anomalies or irregularities encountered in the course of executing the SPC-1 benchmark that may in any way call into question the accuracy, verifiability, or authenticity of information published in this FDR.

There were no anomalies or irregularities encountered during the SPC-1 Remote Audit of the IBM Total Storage SAN Volume Controller 4.2.

APPENDIX A: SPC-1 GLOSSARY

“Decimal” (*powers of ten*) Measurement Units

In the storage industry, the terms “kilo”, “mega”, “giga”, “tera”, “peta”, and “exa” are commonly used prefixes for computing performance and capacity. For the purposes of the SPC workload definitions, all of the following terms are defined in “powers of ten” measurement units.

- A kilobyte (KB) is equal to 1,000 (10^3) bytes.
- A megabyte (MB) is equal to 1,000,000 (10^6) bytes.
- A gigabyte (GB) is equal to 1,000,000,000 (10^9) bytes.
- A terabyte (TB) is equal to 1,000,000,000,000 (10^{12}) bytes.
- A petabyte (PB) is equal to 1,000,000,000,000,000 (10^{15}) bytes
- An exabyte (EB) is equal to 1,000,000,000,000,000,000 (10^{18}) bytes

“Binary” (*powers of two*) Measurement Units

The sizes reported by many operating system components use “powers of two” measurement units rather than “power of ten” units. The following standardized definitions and terms are also valid and may be used in this document.

- A kibibyte (KiB) is equal to 1,024 (2^{10}) bytes.
- A mebibyte (MiB) is equal to 1,048,576 (2^{20}) bytes.
- A gibibyte (GiB) is equal to 1,073,741,824 (2^{30}) bytes.
- A tebibyte (TiB) is equal to 1,099,511,627,776 (2^{40}) bytes.
- A pebibyte (PiB) is equal to 1,125,899,906,842,624 (2^{50}) bytes.
- An exbibyte (EiB) is equal to 1,152,921,504,606,846,967 (2^{60}) bytes.

SPC-1 Data Repository Definitions

Total ASU Capacity: The total storage capacity read and written in the course of executing the SPC-1 benchmark.

Application Storage Unit (ASU): The logical interface between the storage and SPC-1 Workload Generator. The three ASUs (Data, User, and Log) are typically implemented on one or more Logical Volume.

Logical Volume: The division of Addressable Storage Capacity into individually addressable logical units of storage used in the SPC-1 benchmark. Each Logical Volume is implemented as a single, contiguous address space.

Addressable Storage Capacity: The total storage (sum of Logical Volumes) that can be read and written by application programs such as the SPC-1 Workload Generator.

Configured Storage Capacity: This capacity includes the Addressable Storage Capacity and any other storage (parity disks, hot spares, etc.) necessary to implement the Addressable Storage Capacity.

Physical Storage Capacity: The formatted capacity of all storage devices physically present in the Tested Storage Configuration (TSC).

Data Protection Overhead: The storage capacity required to implement the selected level of data protection.

Required Storage: The amount of Configured Storage Capacity required to implement the Addressable Storage Configuration, excluding the storage required for the three ASUs.

Global Storage Overhead: The amount of Physical Storage Capacity that is required for storage subsystem use and unavailable for use by application programs.

Total Unused Storage: The amount of storage capacity available for use by application programs but not included in the Total ASU Capacity.

SPC-1 Data Protection Levels

RAID5: User data is distributed across the disks in the array. Check data corresponding to user data is distributed across multiple disks in the form of bit-by-bit parity.

Mirroring: Two or more identical copies of user data are maintained on separate disks.

Other Protection Level: Any data protection other than **RAID5** or **Mirroring**.

Unprotected: There is no data protection provided.

SPC-1 Test Execution Definitions

Average Response Time: The sum of the Response Times for all Measured I/O Requests divided by the total number of Measured I/O Requests.

Completed I/O Request: An I/O Request with a Start Time and a Completion Time (see "I/O Completion Types" below).

Completion Time: The time recorded by the Workload Generator when an I/O Request is satisfied by the TSC as signaled by System Software.

Data Rate: The data transferred in all Measured I/O Requests in an SPC-1 Test Run divided by the length of the Test Run in seconds.

Expected I/O Count: For any given I/O Stream and Test Phase, the product of 50 times the BSU level, the duration of the Test Phase in seconds, and the Intensity Multiplier for that I/O Stream.

Failed I/O Request: Any I/O Request issued by the Workload Generator that could not be completed or was signaled as failed by System Software. A Failed I/O Request has no Completion Time (see “I/O Completion Types” below).

I/O Request Throughput: The total number of Measured I/O requests in an SPC-1 Test Run divided by the duration of the Measurement Interval in seconds.

In-Flight I/O Request: An I/O Request issued by the I/O Command Generator to the TSC that has a recorded Start Time, but does not complete within the Measurement Interval (see “I/O Completion Types” below).

Measured I/O Request: A Completed I/O Request with a Completion Time occurring within the Measurement Interval (see “I/O Completion Types” below).

Measured Intensity Multiplier: The percentage of all Measured I/O Requests that were issued by a given I/O Stream.

Measurement Interval: The finite and contiguous time period, after the TSC has reached Steady State, when data is collected by a Test Sponsor to generate an SPC-1 test result or support an SPC-1 test result.

Ramp-Up: The time required for the Benchmark Configuration (BC) to produce Steady State throughput after the Workload Generator begins submitting I/O Requests to the TSC for execution.

Ramp-Down: The time required for the BC to complete all I/O Requests issued by the Workload Generator. The Ramp-Down period begins when the Workload Generator ceases to issue new I/O Requests to the TSC.

Response Time: The Response Time of a Measured I/O Request is its Completion Time minus its Start Time.

Start Time: The time recorded by the Workload Generator when an I/O Request is submitted, by the Workload Generator, to the System Software for execution on the Tested Storage Configuration (TSC).

Start-Up: The period that begins after the Workload Generator starts to submit I/O requests to the TSC and ends at the beginning of the Measurement Interval.

Shut-Down: The period between the end of the Measurement Interval and the time when all I/O Requests issued by the Workload Generator have completed or failed.

Steady State: The consistent and sustainable throughput of the TSC. During this period the load presented to the TSC by the Workload Generator is constant.

Test: A collection of Test Phases and or Test Runs sharing a common objective.

Test Run: The execution of SPC-1 for the purpose of producing or supporting an SPC-1 test result. SPC-1 Test Runs may have a finite and measured Ramp-Up period, Start-Up

period, Shut-Down period, and Ramp-Down period as illustrated in the “SPC-1 Test Run Components” below. All SPC-1 Test Runs shall have a Steady State period and a Measurement Interval.

Test Phase: A collection of one or more SPC-1 Test Runs sharing a common objective and intended to be run in a specific sequence.

I/O Completion Types

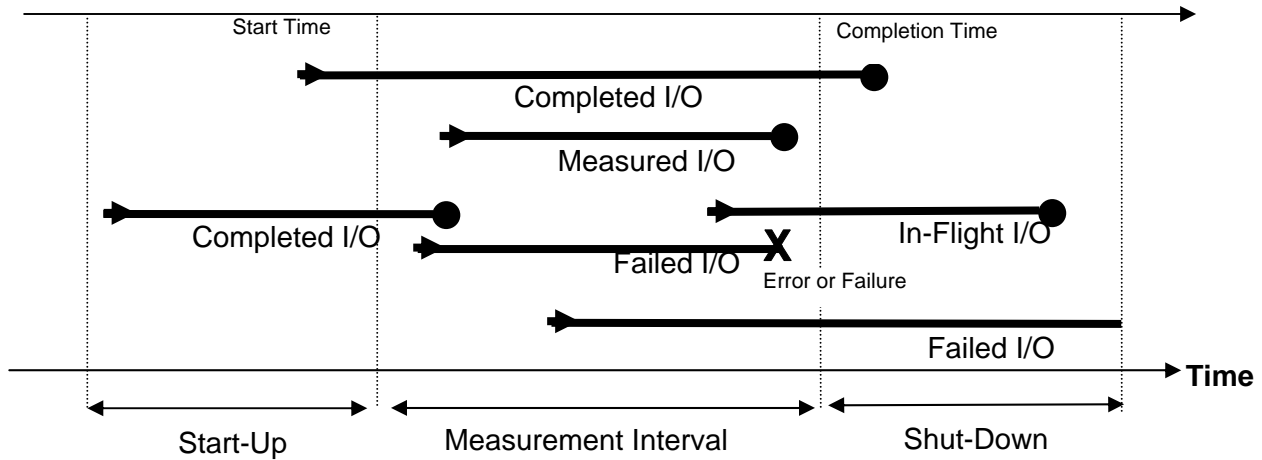

SPC-1 Test Run Components

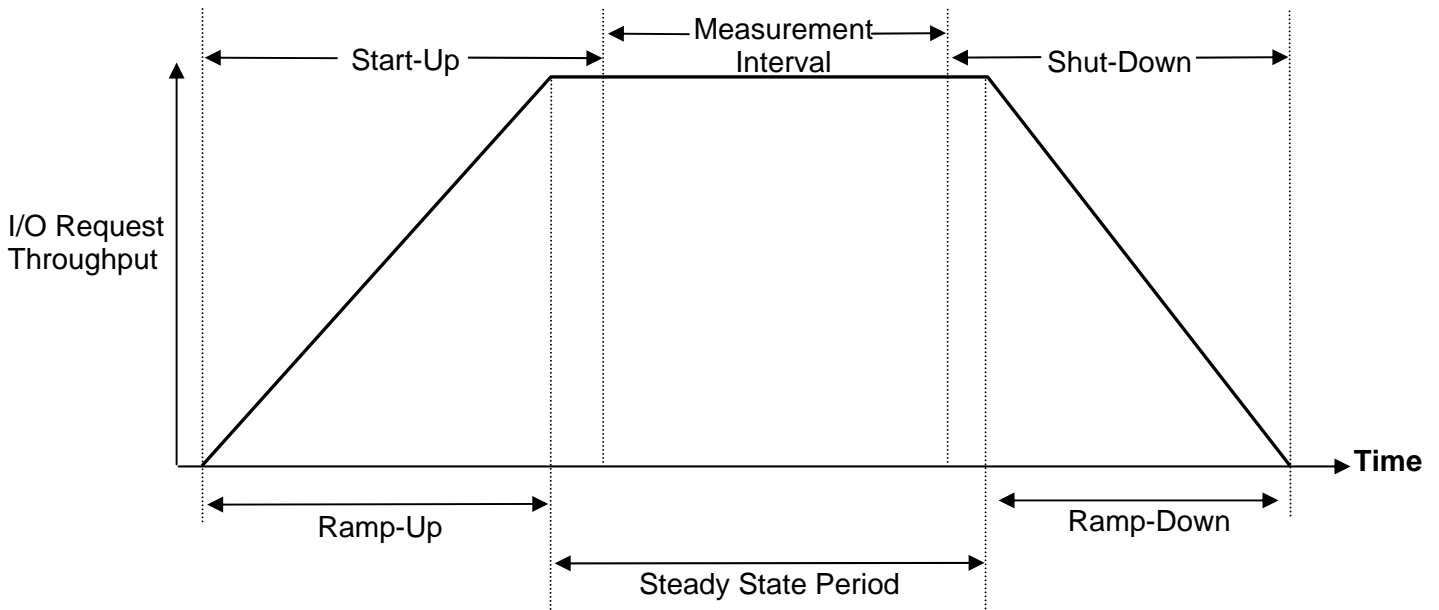

APPENDIX B: CUSTOMER TUNABLE PARAMETERS AND OPTIONS

The following customer tunable parameters/options were changed from their default value:

- In the FAStT logical volume characteristics, media scanning has been disabled (this is enabled by default)
- In the hdisk characteristics, queue depth has been set to 80 and the maximum transfer size to 1024K bytes (defaults are 20 and 256K bytes respectively).

APPENDIX C: TESTED STORAGE CONFIGURATION (TSC) CREATION

Create RAID-10 Arrays (mDisks)

Within each DS4700, eight RAID-10 arrays are defined, with one LUN per array. The odd LUNs are assigned to DS4700 controller "a", and are created with the script `defineRAID10_a.script`. The even LUNs are assigned to DS4700 controller "b", and are created with the script `defineRAID10_b.script`. Both scripts are called repeatedly (for each DS4700) by `defineRAID10.bat`. This script also invokes the SVC "detectmdisk" function, which causes SVC to discover the LUNs and place them into its list of available mDisks.

defineRAID10.bat

```
plink perfclus_local svctask detectmdisk
ping -n 30 192.168.1.31
@rem ping local address for short delay
plink perfclus_local svcinfo lsmdisk > afternone

SMcli -n "A1" -f defineRAID10_a.script
SMcli -n "A2" -f defineRAID10_a.script
SMcli -n "B1" -f defineRAID10_a.script
SMcli -n "B2" -f defineRAID10_a.script
SMcli -n "C1" -f defineRAID10_a.script
SMcli -n "C2" -f defineRAID10_a.script
SMcli -n "D1" -f defineRAID10_a.script
SMcli -n "D2" -f defineRAID10_a.script
ping -n 30 192.168.1.31
plink perfclus_local svctask detectmdisk
ping -n 30 192.168.1.31
plink perfclus_local svcinfo lsmdisk > afters1list

SMcli -n "A1" -f defineRAID10_b.script
SMcli -n "A2" -f defineRAID10_b.script
SMcli -n "B1" -f defineRAID10_b.script
SMcli -n "B2" -f defineRAID10_b.script
SMcli -n "C1" -f defineRAID10_b.script
SMcli -n "C2" -f defineRAID10_b.script
SMcli -n "D1" -f defineRAID10_b.script
SMcli -n "D2" -f defineRAID10_b.script
ping -n 30 192.168.1.31
plink perfclus_local svctask detectmdisk
ping -n 30 192.168.1.31
plink perfclus_local svcinfo lsmdisk > afters2list

SMcli -n "E1" -f defineRAID10_a.script
SMcli -n "E2" -f defineRAID10_a.script
SMcli -n "F1" -f defineRAID10_a.script
SMcli -n "F2" -f defineRAID10_a.script
SMcli -n "G1" -f defineRAID10_a.script
SMcli -n "G2" -f defineRAID10_a.script
SMcli -n "H1" -f defineRAID10_a.script
SMcli -n "H2" -f defineRAID10_a.script
ping -n 30 192.168.1.31
plink perfclus_local svctask detectmdisk
ping -n 30 192.168.1.31
plink perfclus_local svcinfo lsmdisk > afters3list
```

```
SMcli -n "E1" -f defineRAID10_b.script
SMcli -n "E2" -f defineRAID10_b.script
SMcli -n "F1" -f defineRAID10_b.script
SMcli -n "F2" -f defineRAID10_b.script
SMcli -n "G1" -f defineRAID10_b.script
SMcli -n "G2" -f defineRAID10_b.script
SMcli -n "H1" -f defineRAID10_b.script
SMcli -n "H2" -f defineRAID10_b.script
ping -n 30 192.168.1.31
plink perfclus_local svctask detectmdisk
ping -n 30 192.168.1.31
plink perfclus_local svcinfo lsmdisk > afters4list
```

defineRAID10_a.script

```
create logicalDrive drives=(12,1 12,2 12,3 12,4 12,5 12,6 12,7 12,8 12,9 12,10
12,11 12,12)
RAIDLevel=1
segmentSize=256
userLabel="1"
owner=a;
set logicalDrive["1"] logicalUnitNumber=1 hostGroup=defaultGroup;

create logicalDrive drives=(12,13 12,14 12,15 12,16 13,1 13,2 13,3 13,4 13,5 13,6
13,7 13,8)
RAIDLevel=1
segmentSize=256
userLabel="3"
owner=a;
set logicalDrive["3"] logicalUnitNumber=3 hostGroup=defaultGroup;

create logicalDrive drives=(13,9 13,10 13,11 13,12 13,13 13,14 13,15 13,16 14,1
14,2 14,3 14,4)
RAIDLevel=1
segmentSize=256
userLabel="5"
owner=a;
set logicalDrive["5"] logicalUnitNumber=5 hostGroup=defaultGroup;

create logicalDrive drives=(14,5 14,6 14,7 14,8 14,9 14,10 14,11 14,12 14,13 14,14
14,15 14,16)
RAIDLevel=1
segmentSize=256
userLabel="7"
owner=a;
set logicalDrive["7"] logicalUnitNumber=7 hostGroup=defaultGroup;

set storageSubsystem defaultHostType=12 cacheBlockSize=16;
set allLogicalDrives mirrorEnabled=TRUE writeCacheEnabled=TRUE
cacheWithoutBatteryEnabled=FALSE mediaScanEnabled=FALSE readAheadMultiplier=1;
```

defineRAID10_b.script

```
create logicalDrive drives=(81,1 81,2 81,3 81,4 81,5 81,6 81,7 81,8 81,9 81,10
81,11 81,12)
RAIDLevel=1
segmentSize=256
userLabel="2"
```

```
owner=b;
set logicalDrive["2"] logicalUnitNumber=2 hostGroup=defaultGroup;

create logicalDrive drives=(81,13 81,14 81,15 81,16 15,1 15,2 15,3 15,4 15,5 15,6
15,7 15,8)
RAIDLevel=1
segmentSize=256
userLabel="4"
owner=b;
set logicalDrive["4"] logicalUnitNumber=4 hostGroup=defaultGroup;

create logicalDrive drives=(15,9 15,10 15,11 15,12 15,13 15,14 15,15 15,16 16,1
16,2 16,3 16,4)
RAIDLevel=1
segmentSize=256
userLabel="6"
owner=b;
set logicalDrive["6"] logicalUnitNumber=6 hostGroup=defaultGroup;

create logicalDrive drives=(16,5 16,6 16,7 16,8 16,9 16,10 16,11 16,12 16,13 16,14
16,15 16,16)
RAIDLevel=1
segmentSize=256
userLabel="8"
owner=b;
set logicalDrive["8"] logicalUnitNumber=8 hostGroup=defaultGroup;

set storageSubsystem defaultHostType=12 cacheBlockSize=16;
set allLogicalDrives mirrorEnabled=TRUE writeCacheEnabled=TRUE
cacheWithoutBatteryEnabled=FALSE mediaScanEnabled=FALSE readAheadMultiplier=1;
```

Create Definitions for Host System Connectivity

For each of the 32 HBA's in the host processor, the script `mkhost_perfsh3a.bat` defines an SVC host connection using the appropriate WWPN. Due to the usage in AIX, these host paths are also referred to as "fcs's".

`mkhost_perfsh3a.bat`

```
plink perfclus_local svctask mkhost -force -name A0 -hbawwpn 10000000C959795C
plink perfclus_local svctask mkhost -force -name A2 -hbawwpn 10000000C95D40E4
plink perfclus_local svctask mkhost -force -name A4 -hbawwpn 10000000C95E344C
plink perfclus_local svctask mkhost -force -name A6 -hbawwpn 10000000C95E632D
plink perfclus_local svctask mkhost -force -name A8 -hbawwpn 10000000C95CBAA4
plink perfclus_local svctask mkhost -force -name A10 -hbawwpn 10000000C95969BD
plink perfclus_local svctask mkhost -force -name A12 -hbawwpn 10000000C95CBF64
plink perfclus_local svctask mkhost -force -name A14 -hbawwpn 10000000C95CBB42
plink perfclus_local svctask mkhost -force -name A16 -hbawwpn 10000000C95D3F8E
plink perfclus_local svctask mkhost -force -name A18 -hbawwpn 10000000C95D3F88
plink perfclus_local svctask mkhost -force -name A20 -hbawwpn 10000000C95D40BA
plink perfclus_local svctask mkhost -force -name A22 -hbawwpn 10000000C95D40B3
plink perfclus_local svctask mkhost -force -name A24 -hbawwpn 10000000C95CBE91
plink perfclus_local svctask mkhost -force -name A26 -hbawwpn 10000000C95E7667
plink perfclus_local svctask mkhost -force -name A28 -hbawwpn 10000000C95E33C6
plink perfclus_local svctask mkhost -force -name A30 -hbawwpn 10000000C95A6824
plink perfclus_local svctask mkhost -force -name A32 -hbawwpn 10000000C9600F48
plink perfclus_local svctask mkhost -force -name A34 -hbawwpn 10000000C957DC9A
plink perfclus_local svctask mkhost -force -name A36 -hbawwpn 10000000C95D3FB7
plink perfclus_local svctask mkhost -force -name A38 -hbawwpn 10000000C95CBE89
plink perfclus_local svctask mkhost -force -name A41 -hbawwpn 10000000C95CBB06
```

```
plink perfclus_local svctask mkhost -force -name A42 -hbawwpn 10000000C95CBCDA
plink perfclus_local svctask mkhost -force -name A44 -hbawwpn 10000000C95E7E4F
plink perfclus_local svctask mkhost -force -name A46 -hbawwpn 10000000C95E76D3
plink perfclus_local svctask mkhost -force -name A48 -hbawwpn 10000000C95CBCA5
plink perfclus_local svctask mkhost -force -name A50 -hbawwpn 10000000C95D3F2F
plink perfclus_local svctask mkhost -force -name A53 -hbawwpn 10000000C95D3FA8
plink perfclus_local svctask mkhost -force -name A54 -hbawwpn 10000000C95CBC5E
plink perfclus_local svctask mkhost -force -name A56 -hbawwpn 10000000C95CBA39
plink perfclus_local svctask mkhost -force -name A58 -hbawwpn 10000000C95CBEBE
plink perfclus_local svctask mkhost -force -name A60 -hbawwpn 10000000C95988FD
plink perfclus_local svctask mkhost -force -name A62 -hbawwpn 10000000C95CBC96
```

Define the mDisk Group

The next script defines a pool of mDisk storage within the SVC, which is referred to as a mDisk group.

mkgroup.py

```
import os

list="md0"
for i in range(1,128): list=list + ":md" + str(i)

os.system('plink perfclus_local svctask mkmdiskgrp -name thebiggroup -ext 256 -
mdisk ' + list)
```

Define the vDisks (LUNs)

The following script will define 128 vDisks (LUNs) that will be presented to the Host System.

mk128vd_8node_stripe.pyh

```
import os,time

outfile = 'mk128vd_8node_stripe.tmp'

reffile = 'mk128vd_8node_stripe.txt'
if os.access(outfile,0): os.remove(outfile)
if os.access(reffile,0): os.remove(reffile)
i=0

f = open(outfile, 'w')

g = open(reffile,'w')
g.write('Created by script: mk128vd_8node_stripe.py\n')
g.write('Commands executed: '+time.strftime("%c",time.localtime())+'\n\n')
for i in range(128):

    #organize vDisks into sets of 32 each containing groups of 4 by node, 8 by
    iogrp

    print ("i=" + str(i) + " j=" + str(j))

    lode = 1 + ((i % 32) / 4)
    iogrp = (i % 32) / 8
    cmdstr = 'svctask mkvdisk -vtype striped ' + \
        ' -size 192 -unit gb -mdiskgrp thebiggroup -iogrp io_grp' + str(iogrp) + \
```



```
        '-name vd' + str(i) + ' -node lode' + str(lode) + '\n'
    f.write(cmdstr)
    g.write(cmdstr)

f.close()

g.close()
os.system('plink perfclus_local -m ' + outfile)

os.remove(outfile)
```

Define vDisk Paths

Define two paths through which each vDisk can be seen by the host. This is done by the script `mapfcs128to32.py`. This step completes the configuration in SVC. The remaining steps are performed in the host AIX system.

`mapfcs128to32.py`

```
# Maps each vdisk to two fcs's.

import os, time

outfile = 'mapfcs128to32.tmp'

reffile = './mapfcs128to32.txt'
if os.access(outfile,0): os.remove(outfile)
if os.access(reffile,0): os.remove(reffile)

# The fcs's are organized
# into groups of four, with two groups in each switch.
fcsarray = [6,14,18,50, 16,24,53,60, \
            2,32,38,46, 8,20,36,58, \
            10,12,56,62, 22,26,44,48, \
            4,28,41,42, 0,30,34,54]

fcsarray = ['A' + str(v) for v in fcsarray]

f = open(outfile, 'w')
g = open(reffile, 'w')
g.write('Created by script: mapfcs128to32.py\n')
g.write('Commands executed: '+time.strftime("%c",time.localtime())+'\n\n')
for i in range(32):
    k=i - ((i/4)%2)*4 #odd and even nodes are handled symmetrically except for
    offset of 4
    j=(k%4)*8 + k/8 + ((i/4)%2)*4
    print ('mapping primary path: vd'+str(i)+' <--> '+fcsarray[j])
    cmdstr1 = 'svctask mkvdiskhostmap -force -host ' + fcsarray[j] + ' vd' + str(i)
    + '\n'
    f.write(cmdstr1)
    g.write(cmdstr1)
    aj=(k%4)*8 + k/8 + (1-(i/4)%2)*4 +8-16*((j%16)/8)
```

```
    cmdstr2 = 'svctask mkvdiskhostmap -force -host ' + fcsarray[aj] + ' vd' +
str(i) + '\n'
    print ('mapping alternate path: vd'+str(i)+' <--> '+fcsarray[aj])
    f.write(cmdstr2)
    g.write(cmdstr2)
    g.write('=====\n')

    for repeat in range (1,4):
        ii=i+32*repeat

        print ('mapping primary path: vd'+str(ii)+' <--> '+fcsarray[j])
        cmdstr1 = 'svctask mkvdiskhostmap -force -host ' + fcsarray[j] + ' vd' +
str(ii) + '\n'
        f.write(cmdstr1)
        g.write(cmdstr1)
        cmdstr2 = 'svctask mkvdiskhostmap -force -host ' + fcsarray[aj] + ' vd' +
str(ii) + '\n'
        print ('mapping alternate path: vd'+str(ii)+' <--> '+fcsarray[aj])
        f.write(cmdstr2)
        g.write(cmdstr2)
        g.write('=====\n')
    f.close()

    g.close()
    os.system('plink perfclus_local -m ' + outfile)

    os.remove(outfile)
```

Discover each vDisk

This next script discovers the vDisks available to the Host System. The process of discovery uses MPIIO; as a result, one hdisk is found for each vDisk, which is accessible via a primary and an alternate path.

cfgthesefcs.sh

```
i=$1
for i in 0 2 4 6 8 10 12 14 16 18 20 22 24 26 28 30 32 34 36 38 41 42 44 46 48 50
53 54 56 58 60 62
do
    cfgmgr -vl fcs$i > fcs$i.cfg
    i=$((i+1))
done
```

Increase hdisk queue depth

Invoking the following script sets the queue depth of each hdisk to 80 and its maximum transfer size to 1024K.

hdiskset.sh 5 132 80 0x100000

```
if [[ $# -lt 4 ]]
then
    echo "usage: chqdepth start_hdisk end_hdisk qdepth xfer"
    exit
fi

i=$1
n=$2
q=$3
```

```
x=$4

while [[ $i -le $n ]]
do
  rmdev -l hdisk$i
  chdev -l hdisk$i -a queue_depth=$q
  chdev -l hdisk$i -a max_transfer=$x
  mkdev -l hdisk$i
  i=$((i+1))
done
```

Create a striped volume group

Form the vDisks (which after discovery also correspond to AIX hdisks) into a logical volume group, and define a set of striped logical volumes. Each striped logical volume contains 2560 partitions, with a partition size of 256 MiB. These actions are done by invoking `stripethem.sh 2560 256`.

`stripethem.sh 2560 256`

```
# makes striped volume group from available hdisks; makes vols with a specified
number of specified meg partitions.
# important: assumes MPIO, assumes no. of hdisks divides no. of partitions.
if [[ ($# -lt 2) ]]
then
  echo "usage: stripethem partitions psize. Partitions should be divisible by
hdisks"
  exit
fi
partspervol=$1
psize=$2

hfield=$(lsdev -Cc disk | grep 'SAN Volume Controller MPIO Device' | awk '{print
$1}')
mkvg -fy thinstripevg -S -s $psize $hfield

hnum=`echo $hfield | wc -w`
parts=`lsvg thinstripevg | grep "FREE PPs:" | awk '{print $6}'`
let numlv="parts / partspervol"
let usedparts="partspervol * numlv"
print "creating $numlv logical volumes"
print "these will use $usedparts out of $parts available partitions"
l=1
while [[ $l -le $numlv ]]
do
  mklv -b n -y thin$l -x 32512 -u $hnum -S 256K thinstripevg $partspervol
  l=$((l+1))
done
```

APPENDIX D: SPC-1 WORKLOAD GENERATOR STORAGE COMMANDS AND PARAMETERS

The SPC-1 Workload Generator command and parameter file used in this benchmark is listed below.

```
javaparms="-Xms384m -Xmx768m -Xss128k -Xgcpolicy:optavgpause"  
sd=default,size=687194767360  
sd=asu1_1,lun=/dev/rthin1  
sd=asu1_2,lun=/dev/rthin2  
sd=asu1_3,lun=/dev/rthin3  
sd=asu1_4,lun=/dev/rthin4  
sd=asu1_5,lun=/dev/rthin5  
sd=asu1_6,lun=/dev/rthin6  
sd=asu1_7,lun=/dev/rthin7  
sd=asu1_8,lun=/dev/rthin8  
sd=asu1_9,lun=/dev/rthin9  
sd=asu1_10,lun=/dev/rthin10  
sd=asu1_11,lun=/dev/rthin11  
sd=asu1_12,lun=/dev/rthin12  
sd=asu1_13,lun=/dev/rthin13  
sd=asu1_14,lun=/dev/rthin14  
sd=asu1_15,lun=/dev/rthin15  
sd=asu1_16,lun=/dev/rthin16  
sd=asu2_1,lun=/dev/rthin17  
sd=asu2_2,lun=/dev/rthin18  
sd=asu2_3,lun=/dev/rthin19  
sd=asu2_4,lun=/dev/rthin20  
sd=asu2_5,lun=/dev/rthin21  
sd=asu2_6,lun=/dev/rthin22  
sd=asu2_7,lun=/dev/rthin23  
sd=asu2_8,lun=/dev/rthin24  
sd=asu2_9,lun=/dev/rthin25  
sd=asu2_10,lun=/dev/rthin26  
sd=asu2_11,lun=/dev/rthin27  
sd=asu2_12,lun=/dev/rthin28  
sd=asu2_13,lun=/dev/rthin29  
sd=asu2_14,lun=/dev/rthin30  
sd=asu2_15,lun=/dev/rthin31  
sd=asu2_16,lun=/dev/rthin32  
sd=asu3_1,size=610839m,lun=/dev/rthin33  
sd=asu3_2,size=610839m,lun=/dev/rthin34  
sd=asu3_3,size=610839m,lun=/dev/rthin35  
sd=asu3_4,size=610839m,lun=/dev/rthin36
```

APPENDIX E: SPC-1 WORKLOAD GENERATOR INPUT PARAMETERS

The following script was used to execute the Primary Metrics Test (*Sustainability Test Phase, IOPS Test Phase, and Response Time Ramp Test Phase*), Repeatability Test (*Repeatability Test Phase 1 and Repeatability Test Phase 2*), and Persistence Test Run 1. The content of the `javaopts.cfg` and `javaoptsp.cfg` files are also listed below.

```
export PATH=$PATH:/usr/java14/bin
export SPC1HOME=/perform/spclinstall
export CLASSPATH=$SPC1HOME
export LIBPATH=$SPC1HOME/aix
export IBM_JAVADUMP_OUTOFMEMORY=false
export IBM_HEAPDUMP_OUTOFMEMORY=false
java -Xoptionsfile=javaopts.cfg metrics -b 5450
java -Xoptionsfile=javaopts.cfg repeat1 -b 5450
java -Xoptionsfile=javaopts.cfg repeat2 -b 5450
java -Xoptionsfile=javaoptsp.cfg persist1 -b 5450
```

javaopts.cfg

```
-Xms384m -Xmx768m -Xss128k -Xgcpolicy:subpool
```

javaoptsp.cfg

```
-Xms384m -Xmx1024m -Xss64k -Xgcpolicy:optavgpause
```

The following script was used to execute Persistence Test Run 2.

```
export PATH=$PATH:/usr/java14/bin
export SPC1HOME=/perform/spclinstall
export CLASSPATH=$SPC1HOME
export LIBPATH=$SPC1HOME/aix
export IBM_JAVADUMP_OUTOFMEMORY=false
export IBM_HEAPDUMP_OUTOFMEMORY=false
java -Xoptionsfile=javaoptsp.cfg persist2
```