



**SPC BENCHMARK 1™
FULL DISCLOSURE REPORT**

**IBM CORPORATION
IBM TOTALSTORAGE® DS8300** *(RELEASE 6.1.600)*

SPC-1 V1.9

**Submitted for Review: October 27, 2005
Submission Identifier: A00044
Accepted: December 26, 2005**



First Edition – October 2005

THE INFORMATION CONTAINED IN THIS DOCUMENT IS DISTRIBUTED ON AN AS IS BASIS WITHOUT ANY WARRANTY EITHER EXPRESS OR IMPLIED. The use of this information or the implementation of any of these techniques is the customer's responsibility and depends on the customer's ability to evaluate and integrate them into the customer's operational environment. While each item has been reviewed by IBM Corporation for accuracy in a specific situation, there is no guarantee that the same or similar results will be obtained elsewhere. Customers attempting to adapt these techniques to their own environment do so at their own risk.

This publication was produced in the United States. IBM Corporation may not offer the products, services, or features discussed in this document in other countries, and the information is subject to change with notice. Consult your local IBM Corporation representative for information on products and services available in your area.

© Copyright IBM Corporation 2005. All rights reserved.

Permission is hereby granted to reproduce this document in whole or in part, provided the copyright notice as printed above is set forth in full text on the title page of each item reproduced.

Trademarks

SPC Benchmark 1, SPC-1 IOPS, and SPC-1 LRT are trademarks of the Storage Performance Council. IBM and TotalStorage are registered trademarks of IBM Corporation in the United States and other countries. UNIX is a registered trademark of The Open Group in the United States and other countries. All other brands, trademarks, and product names are the property of their respective owners.

Notes

The following terms, used in this document, are defined as:

- Kilobyte (KB) is equal to 1,000 (10^3) bytes.
- Megabyte (MB) is equal to 1,000,000 (10^6) bytes.
- Gigabyte (GB) is equal to 1,000,000,000 (10^9) bytes.
- Terabyte (TB) is equal to 1,000,000,000,000 (10^{12}) bytes.
- A petabyte (PB) is equal to 1,000,000,000,000,000 (10^{15}) bytes.
- An exabyte (EB) is equal to 1,000,000,000,000,000,000 (10^{18}) bytes.

Table of Contents

Audit Certification	vi
Audit Certification (cont.)	vii
Letter of Good Faith	viii
Executive Summary	9
Test Sponsor and Contact Information	9
Revision Information and Key Dates	9
Summary of Results	10
Storage Capacities and Relationships	10
Response Time - Throughput Curve	11
Response Time - Throughput Data	11
Tested Storage Configuration Pricing (Priced Storage Configuration)	12
Tested Storage Configuration Pricing (Priced Storage Configuration) - cont. ..	13
Differences between the Tested Storage Configuration (TSC) and Priced Storage Configuration	13
Benchmark Configuration/Tested Storage Configuration Diagram	14
Configuration Information	15
Benchmark Configuration (BC)/Tested Storage Configuration (TSC) Diagram .15	15
Storage Network Configuration	15
Host System Configuration	16
Customer Tunable Parameters and Options	16
Tested Storage Configuration (TSC) Description	16
SPC-1 Workload Generator Storage Configuration	17
Data Repository	18
Definitions	18
Storage Capacities and Relationships	19
SPC-1 Storage Capacities	19
SPC-1 Storage Hierarchy Ratios	19
SPC-1 Storage Capacities and Relationships Illustration	20
Logical Volume Capacity and ASU Mapping	20
SPC-1 Benchmark Execution Results	21
Definitions	21
Primary Metrics Test - Sustainability Test Phase	22
SPC-1 Workload Generator Input Parameters	22
Sustainability Test Results File	22
Sustainability - Data Rate Distribution Data (<i>MB/second</i>).....	23

Sustainability – Data Rate Distribution Graph	24
Sustainability – I/O Request Throughput Distribution Data	25
Sustainability – I/O Request Throughput Distribution Graph	26
Sustainability – Average Response Time (ms) Distribution Data	26
Sustainability – Average Response Time (ms) Distribution Data	27
Sustainability – Average Response Time (ms) Distribution Graph	28
Sustainability – Response Time Frequency Distribution Data	29
Sustainability – Response Time Frequency Distribution Graph	29
Sustainability – Measured Intensity Multiplier and Coefficient of Variation.....	30
Primary Metrics Test – IOPS Test Phase.....	31
SPC-1 Workload Generator Input Parameters	31
IOPS Test Results File.....	31
IOPS Test Run – I/O Request Throughput Distribution Data	32
IOPS Test Run – I/O Request Throughput Distribution Graph.....	32
IOPS Test Run – Response Time Frequency Distribution Data	33
IOPS Test Run –Response Time Frequency Distribution Graph.....	33
IOPS Test Run – Average Response Time (ms) Distribution Data	34
IOPS Test Run – Average Response Time (ms) Distribution Graph	34
IOPS Test Run – I/O Request Information.....	35
IOPS Test Run – Measured Intensity Multiplier and Coefficient of Variation.....	35
Primary Metrics Test – Response Time Ramp Test Phase	36
SPC-1 Workload Generator Input Parameters	36
Response Time Ramp Test Results File.....	36
Response Time Ramp Distribution (IOPS) Data.....	37
Response Time Ramp Distribution (IOPS) Graph	38
SPC-1 LRT™ Average Response Time (ms) Distribution Data.....	39
SPC-1 LRT™ Average Response Time (ms) Distribution Graph	39
SPC-1 LRT™ (10%) – Measured Intensity Multiplier and Coefficient of Variation	40
Repeatability Test	41
SPC-1 Workload Generator Input Parameters	41
Repeatability Test Results File	42
Repeatability 1 LRT – I/O Request Throughput Distribution Data.....	43
Repeatability 1 LRT – I/O Request Throughput Distribution Graph	43
Repeatability 1 LRT –Average Response Time (ms) Distribution Data	44
Repeatability 1 LRT –Average Response Time (ms) Distribution Graph.....	44
Repeatability 1 IOPS – I/O Request Throughput Distribution Data	45
Repeatability 1 IOPS – I/O Request Throughput Distribution Graph.....	45
Repeatability 1 IOPS –Average Response Time (ms) Distribution Data.....	46
Repeatability 1 IOPS –Average Response Time (ms) Distribution Graph	46

Repeatability 2 LRT – I/O Request Throughput Distribution Data.....	47
Repeatability 2 LRT – I/O Request Throughput Distribution Graph	47
Repeatability 2 LRT –Average Response Time (ms) Distribution Data	48
Repeatability 2 LRT –Average Response Time (ms) Distribution Graph.....	48
Repeatability 2 IOPS – I/O Request Throughput Distribution Data	49
Repeatability 2 IOPS – I/O Request Throughput Distribution Graph.....	49
Repeatability 2 IOPS –Average Response Time (ms) Distribution Data.....	50
Repeatability 2 IOPS –Average Response Time (ms) Distribution Graph	50
Repeatability 1 (LRT) Measured Intensity Multiplier and Coefficient of Variation.....	51
Repeatability 1 (IOPS) Measured Intensity Multiplier and Coefficient of Variation	51
Repeatability 2 (LRT) Measured Intensity Multiplier and Coefficient of Variation.....	51
Repeatability 2 (IOPS) Measured Intensity Multiplier and Coefficient of Variation	52
Data Persistence Test.....	53
SPC-1 Workload Generator Input Parameters	53
Data Persistence Test Results File	53
Data Persistence Test Results.....	54
Priced Storage Configuration Availability Date.....	55
Pricing Information.....	55
Anomalies or Irregularities	55
Appendix A: Customer Tunable Parameters and Options.....	56
Appendix B: Tested Storage Configuration (TSC) Creation	57
Create the RAID-10 ranks	57
Create the LUNs	60
Define the LUN access paths	62
Discover the LUNs and create multi-path hdisks.....	63
Create logical volume group and logical volumes.....	64
Appendix C: SPC-1 Workload Generator Storage Commands and Parameters	67
Appendix D: SPC-1 Workload Generator Input Parameters.....	68

AUDIT CERTIFICATION



Bruce McNutt
 IBM Corporation
 KBV/9062-2
 9000 South Rita Road
 Tucson, AZ 85744

October 26, 2005

The SPC Benchmark 1™ results listed below for the IBM TotalStorage® DS8300 (Release 6.1.600) were produced in compliance with the SPC Benchmark 1™ V1.9 Remote Audit requirements.

SPC Benchmark 1™ V1.9 Results	
Tested Storage Configuration (TSC) Name: IBM TotalStorage® DS8300 (Release 6.1.600)	
Metric	Reported Result
SPC-1 IOPS™	101,101.68
SPC-1 Price-Performance	\$21.61/SPC-1 IOPS™
Total ASU Capacity	6,755.600 GB
Data Protection Level	Mirroring
Total TSC Price (including three-year maintenance)	\$2,185,472

The following SPC Benchmark 1™ Remote Audit requirements were reviewed and found compliant with V1.9 of the SPC Benchmark 1™ specification:

- A Letter of Good Faith, signed by a senior executive.
- The following Data Repository storage items were verified using information supplied by IBM Corporation:
 - ✓ Physical Storage Capacity and requirements.
 - ✓ Configured Storage Capacity and requirements.
 - ✓ Addressable Storage Capacity and requirements.
 - ✓ Capacity of each Logical Volume and requirements.
 - ✓ Capacity of each Application Storage Unit (ASU) and requirements.
- An appropriate diagram of the Benchmark Configuration (BC)/Tested Storage Configuration (TSC).

Storage Performance Council
 643 Bair Island Road, Suite 103
 Redwood City, CA 94062
AuditService@storageperformance.org
 650.556.9384

AUDIT CERTIFICATION (CONT.)

IBM TotalStorage® DS8300 (Release 6.1.600)
SPC-1 Audit Certification

Page 2

- Listings and commands to configure the Benchmark Configuration/Tested Storage Configuration, including customer tunable parameters.
- Commands and parameters used to configure the SPC-1 Workload Generator.
- The following Host System requirements were reviewed using documentation supplied by IBM Corporation:
 - ✓ The type of Host System including the number of processors and main memory.
 - ✓ The presence and version number of the Workload Generator on the Host System.
 - ✓ The TSC boundary within the Host System.
- The Test Results Files and resultant Summary Results Files received from IBM Corporation for each of following were authentic, accurate, and compliant with all of the requirements and constraints of Clauses 4 and 5 of the SPC-1 Benchmark Specification:
 - ✓ Data Persistence Test
 - ✓ Sustainability Test Phase
 - ✓ IOPS Test Phase
 - ✓ Response Time Ramp Test Phase
 - ✓ Repeatability Test
- There were no differences between the Tested Storage Configuration (TSC) used for the benchmark and Priced Storage Configuration.
- The final version of the pricing spreadsheet met all of the requirements and constraints of Clause 8 of the SPC-1 Benchmark Specification.
- The Full Disclosure Report (FDR) met all of the requirements in Clause 9 of the SPC-1 Benchmark Specification.

Respectfully,

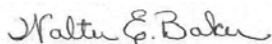

Walter E. Baker
SPC Auditor

Storage Performance Council
643 Bair Island Road, Suite 103
Redwood City, CA 94062
AuditService@storageperformance.org
650.556.9384

LETTER OF GOOD FAITH

Vice President & BLE, Disk Storage

IBM Technology & Systems Group
5600 Cottle Road, San Jose, California 95193

Phone: 408-256-7406
Fax: 408-256-7420

October 18, 2005

Mr. Walter E. Baker, SPC Auditor
Gradient Systems, Inc.
643 Bair Island Road, Suite 103
Redwood City, CA 94063

Subject: SPC-1 Letter of Good Faith for the IBM TotalStorage DS8300

IBM Corporation is the SPC-1 Test Sponsor for the above listed product. To the best of our knowledge and belief, the required SPC-1 benchmark results and materials we have submitted for that product are complete, accurate, and in full compliance with Version 1.9 of the SPC-1 benchmark specification.

Our disclosure of the Benchmark configuration and execution of the benchmark includes all items that, to the best of our knowledge and belief, materially affect the reported results, regardless of whether such items are explicitly required to be disclosed by the SPC-1 benchmark specification.

Sincerely,

A handwritten signature in black ink, appearing to read 'Barry Rudolph'.

Barry Rudolph

EXECUTIVE SUMMARY**Test Sponsor and Contact Information**

Test Sponsor and Contact Information	
Test Sponsor Primary Contact	IBM Corporation – http://www.ibm.com Peter Leung – leungp@us.ibm.com 65S/9062-2 9000 South Rita Road Tucson, AZ 85744 Phone: (520) 799-2853 FAX: (520) 799-5530
Test Sponsor Alternate Contact	IBM Corporation – http://www.ibm.com Bruce McNutt – bmcnutt@us.ibm.com KBV/9062-2 9000 South Rita Road Tucson, AZ 85744 Phone: (520) 799-2460 FAX: (520) 799-5530
Auditor	Storage Performance Council – http://www.StoragePerformance.org Walter E. Baker – AuditService@StoragePerformance.org 643 Bair Island Road, Suite 103 Redwood City, CA 94063 Phone: (650) 556-9384 FAX: (650) 556-9385

Revision Information and Key Dates

Revision Information and Key Dates	
SPC-1 Specification revision number	V1.9
SPC-1 Workload Generator revision number	V2.00.04a
Date Results were first used publicly	October 27, 2005
Date the FDR was submitted to the SPC	October 27, 2005
Date the TSC is available for shipment to customers	January 27, 2006
Date the TSC completed audit certification	October 26, 2005

Summary of Results

SPC-1 Results	
Tested Storage Configuration (TSC) Name: IBM TotalStorage® DS8300 (Release 6.1.600)	
Metric	Reported Result
SPC-1 IOPS™	101,101.68
SPC-1 Price-Performance	\$21.61/SPC-1 IOPS™
Total ASU Capacity	6,755.600 GB
Data Protection Level	Mirroring
Total TSC Price (including three-year maintenance)	\$2,185,472

SPC-1 IOPS™ represents the maximum I/O Request Throughput at the 100% load point.

Total ASU (Application Storage Unit) Capacity represents the total storage capacity read and written in the course of executing the SPC-1 benchmark.

A **Data Protection Level** of Mirroring configures two or more identical copies of user data.

Storage Capacities and Relationships

The following diagram documents the various storage capacities, used in this benchmark, and their relationships.

Response Time – Throughput Curve

The Response Time-Throughput Curve illustrates the Average Response Time (milliseconds) and I/O Request Throughput at 100%, 95%, 90%, 80%, 50%, and 10% of the workload level used to generate the SPC-1 IOPS™ metric.

The Average Response Time measured at any of the above load points cannot exceed 30 milliseconds or the benchmark measurement is invalid.

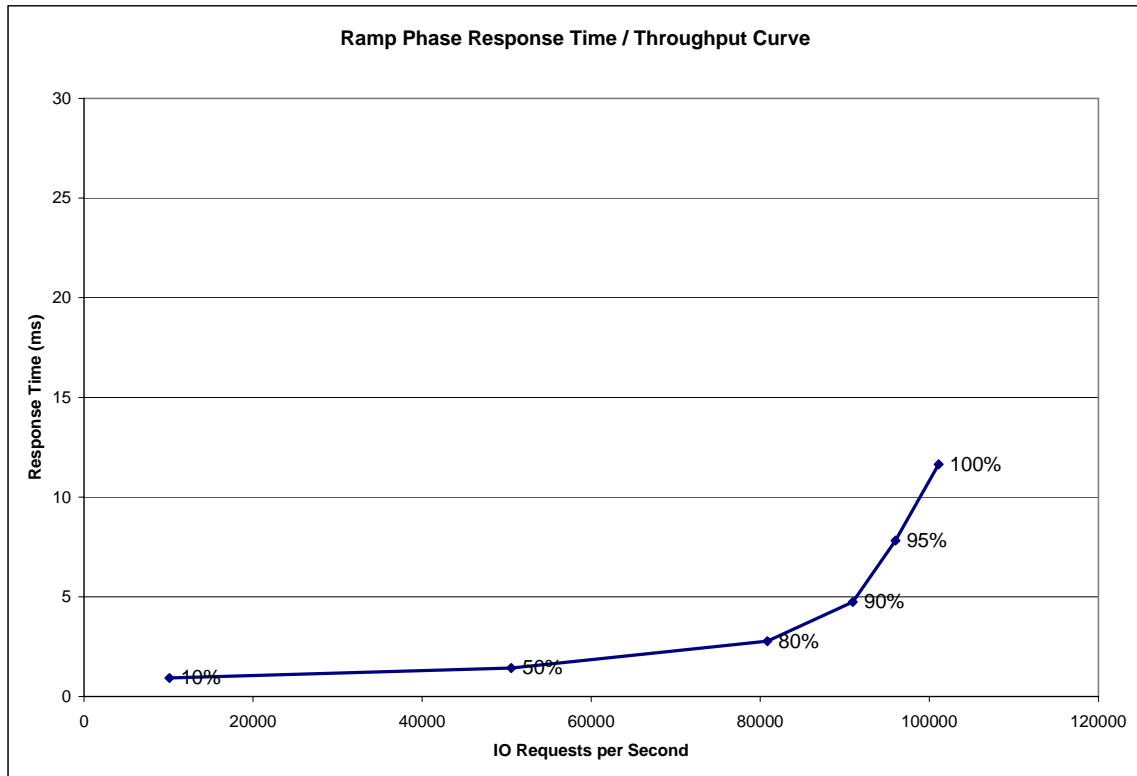

Response Time – Throughput Data

	10% Load	50% Load	80% Load	90% Load	95% Load	100% Load
I/O Request Throughput	10,104.16	50,552.23	80,836.03	90,940.32	95,998.25	101,101.68
Average Response Time (ms):						
All ASUs	0.93	1.43	2.77	4.74	7.82	11.64
ASU-1	1.07	1.55	2.81	4.67	7.67	11.40
ASU-2	1.34	1.91	3.35	5.27	8.34	11.82
ASU-3	0.46	0.95	2.45	4.65	7.90	12.08
Reads	1.75	2.53	4.21	6.22	9.34	12.98
Writes	0.40	0.71	1.84	3.77	6.83	10.78

Tested Storage Configuration Pricing (*Priced Storage Configuration*)

Product	Description	Quantity	Unit Price	Extended Purchase
2107-922	TotalStorage DS8300	1	190,000.00	190,000.00
	1 9xE factory merge	2	N/C	N/C
	221 922 - 92E Position 1	1	N/C	N/C
	222 922 - 92E Position 2	1	N/C	N/C
	700 OEL Indicator	1	N/C	N/C
	815 25.1 to 50.0 TB capacity	1	N/C	N/C
	900 Non-Standby CoD	1	N/C	N/C
	1050 Battery Assembly	3	1,700.00	5,100.00
	1090 Line Cord (US/LA/AP/Canada)	1	1,900.00	1,900.00
	1100 Management Console Internal	1	10,000.00	10,000.00
	1210 Disk Enclosure Pair	4	10,000.00	40,000.00
	1211 Disk Drive Cable Group 1	1	1,000.00	1,000.00
	1300 I/O Enclosure Pair	2	12,500.00	25,000.00
	1316 RIO-G Cable Group 6	1	1,600.00	1,600.00
	1411 50 um Fibre Cable (LC/SC)	16	100.00	1,600.00
	2016 73 GB 15K Drive Set	8	26,000.00	208,000.00
	3011 Device Adapter Pair	4	10,000.00	40,000.00
	3111 2Gb SW FCP/FICON Adapter	16	20,500.00	328,000.00
	4105 256 GB Processor Memory	1	800,000.00	800,000.00
	9090 AC Voltage: 200V - 240V	1	N/C	N/C
	9100 MC Keyboard - US English	1	N/C	N/C
	Serial: N/A	Total		1,652,200.00
2107-92E	TotalStorage DS8000 Enclosure Unit	1	75,000.00	75,000.00
	1 9xE factory merge	1	N/C	N/C
	222 922 - 92E Position 2	1	N/C	N/C
	1090 Line Cord (US/LA/AP/Canada)	1	1,900.00	1,900.00
	1210 Disk Enclosure Pair	4	10,000.00	40,000.00
	1214 Disk Drive Cable Group 4	1	2,400.00	2,400.00
	2016 73 GB 15K Drive Set	8	26,000.00	208,000.00
	9090 AC Voltage: 200V - 240V	1	N/C	N/C
	Serial: N/A	Total		327,300.00

Tested Storage Configuration Pricing (*Priced Storage Configuration*) – cont.

Product	Description	Quantity	Unit Price	Extended Purchase
2107-92E	TotalStorage DS8000 Enclosure Unit	1	75,000.00	75,000.00
	1 9xE factory merge	1	N/C	N/C
	221 922 - 92E Position 1	1	N/C	N/C
	1020 Power Module second pair	1	N/C	N/C
	1050 Battery Assembly	3	1,700.00	5,100.00
	1090 Line Cord (US/LA/AP/Canada)	1	1,900.00	1,900.00
	1210 Disk Enclosure Pair	8	10,000.00	80,000.00
	1212 Disk Drive Cable Group 2	1	1,900.00	1,900.00
	1300 I/O Enclosure Pair	2	12,500.00	25,000.00
	1314 RIO-G Cable Group 4	1	2,300.00	2,300.00
	2016 73 GB 15K Drive Set	16	26,000.00	416,000.00
	3011 Device Adapter Pair	4	10,000.00	40,000.00
	9090 AC Voltage: 200V - 240V	1	N/C	N/C
	Serial: N/A	Total		647,200.00
2244-OEL	DS8000 Function Authorization	1	N/C	N/C
	7001 OEL - 1 TB Unit	3	6,750.00	20,250.00
	7003 OEL - 10 TB Unit	1	54,500.00	54,500.00
	7004 OEL - 25 TB Unit	1	87,500.00	87,500.00
	Serial: N/A	Total		162,250.00
====	Non-S8300 charges			
	5716 P5 595 adapter (2 Gbit, PCI-X)	32	2,720.00	87,040.00
	Short wave FC cable (2 Gbit, 25m)	32	210.00	6,720.00
		Total		93,760.00
	Total DS8300 Charges			2,788,950.00
	Field Delegation Discount of 25%			697,237.50
	Total DS8300 Charges after discount			2,091,712.50
	Non-DS8300 Charges			93,760.00
	Total Charges			2,185,472.50

The above pricing provides maintenance/support for 24 hours per day, 7 days per week for three years with four hour acknowledgement and four hour subsequent response (support engineer onsite or customer replaceable part available).

Differences between the Tested Storage Configuration (TSC) and Priced Storage Configuration

There were no differences between the Tested Storage Configuration and the Priced Storage Configuration.

Benchmark Configuration/Tested Storage Configuration Diagram

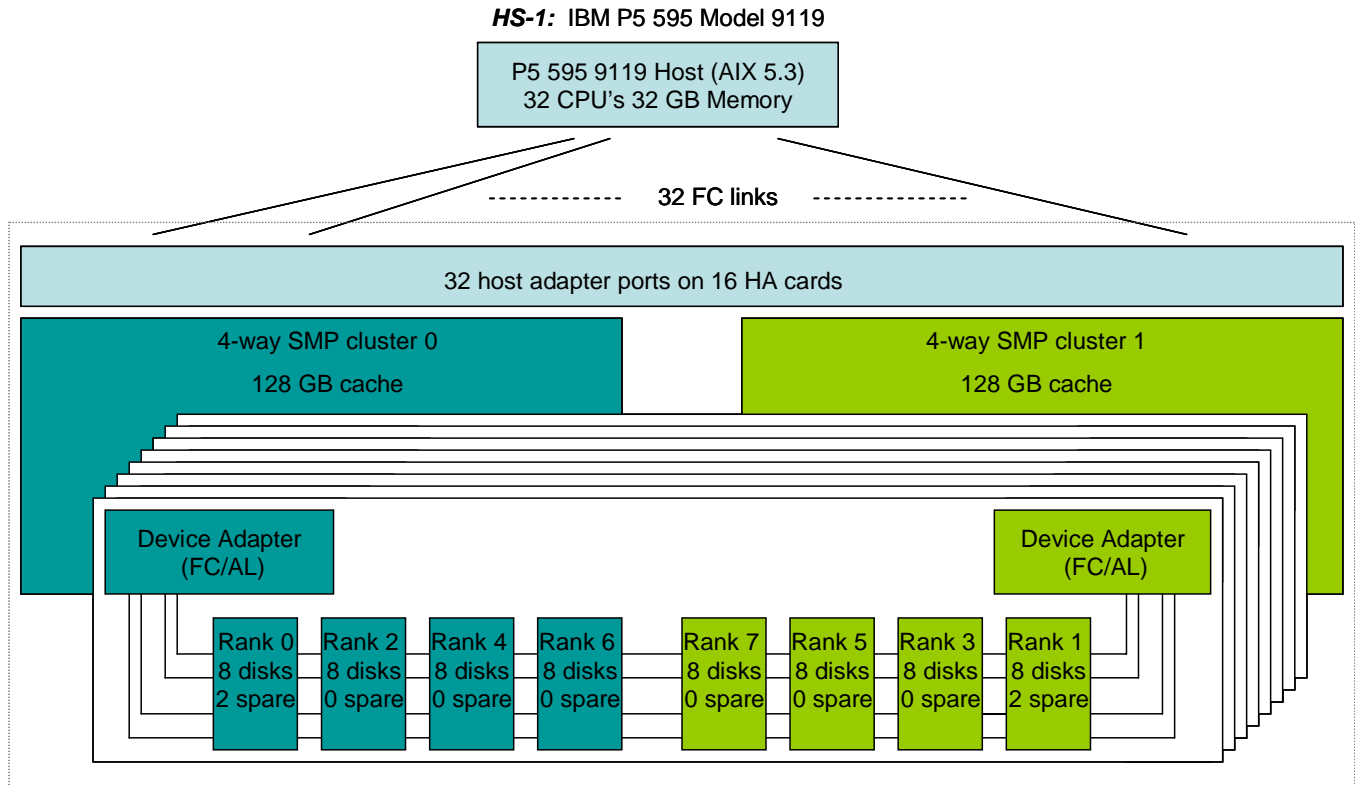

SC-1: IBM TotalStorage® DS8300 (Release 6.1.600)

Host Systems:	Tested Storage Configuration (TSC):
UID=HS-1	32 – P5 595 adapters (2Gb, PCI-X)
IBM P5 595 Model 9119	UID=SC-1: TotalStorage® DS8300 (Release 6.1.600) Each cluster contains: 4 POWER5 CPUs 128 GB processor memory/cluster
32 – 1.9 GHz CPUs – 2 CPUs/POWER5 chip 32 KB L1 cache, 960 KB L2 cache, and 18 MB L3 cache per CPU	
32 GB main memory	
AIX 5.3	
PCI-X/RIO	
WG	8 – 4-port 2Gb/s FC-AL device adapter pairs
	16 – 2Gb SW FCP/FICON adapters
	32 – Disk enclosure pairs
	16 – 73 GB, 15K RPM disk drives per enclosure

CONFIGURATION INFORMATION

Benchmark Configuration (BC)/Tested Storage Configuration (TSC) Diagram

Clause 9.2.4.4.1

A one page Benchmark Configuration (BC)/Tested Storage Configuration (TSC) diagram shall be included in the Executive Summary...

The Benchmark Configuration (BC)/Tested Storage Configuration (TSC) is illustrated on page 14 (Benchmark Configuration/Tested Storage Configuration Diagram).

Storage Network Configuration

Clause 9.2.4.4.1

...

- 5. If the TSC contains network storage, the diagram will include the network configuration. If a single diagram is not sufficient to illustrate both the Benchmark Configuration and network configuration in sufficient detail, the Benchmark Configuration diagram will include a high-level network illustration as shown in Figure 9-8. In that case, a separate, detailed network configuration diagram will also be included as described in Clause 9.2.4.4.2.*

Clause 9.2.4.4.2

If a storage network was configured as a part of the Tested Storage Configuration and the Benchmark Configuration diagram described in Clause 9.2.4.4.1 contains a high-level illustration of the network configuration, the Executive Summary will contain a one page topology diagram of the storage network as illustrated in Figure 9-9.

The storage network configured as a part of the Tested Storage Configuration is illustrated on page 14 (Benchmark Configuration/Tested Storage Configuration Diagram).

Host System Configuration

Clause 9.2.4.4.3

The FDR shall minimally contain, for each Host System running the Workload Generator, a listing of the following:

1. Number and type of CPUs.
2. Main memory capacity.
3. Cache memory capacity.
4. Number and type of disk controllers or Host Bus Adapters.

The details of the Host System configuration may be found on page 14 (*Benchmark Configuration/Tested Storage Configuration Diagram*).

Customer Tunable Parameters and Options

Clause 9.2.4.5.1

All Benchmark Configuration (BC) components with customer tunable parameter and options that have been altered from their default values must be listed in the FDR. The FDR entry for each of those components must include both the name of the component and the altered value of the parameter or option. If the parameter name is not self-explanatory to a knowledgeable practitioner, a brief description of the parameter's use must also be included in the FDR entry.

“Appendix A: Customer Tunable Parameters and Options” on page 56 contains the customer tunable parameters and options that have been altered from their default values for this benchmark.

Tested Storage Configuration (TSC) Description

Clause 9.2.4.5.2

The FDR must include sufficient information to recreate the logical representation of the TSC. In addition to customer tunable parameters and options (Clause 4.2.4.5.3), that information must include, at a minimum:

- A diagram and/or description of the following:
 - All physical components that comprise the TSC. Those components are also illustrated in the BC Configuration Diagram in Clause 9.2.4.4.1 and/or the Storage Network Configuration Diagram in Clause 9.2.4.4.2.
 - The logical representation of the TSC, configured from the above components that will be presented to the Workload Generator.
- Listings of scripts used to create the logical representation of the TSC.
- If scripts were not used, a description of the process used with sufficient detail to recreate the logical representation of the TSC.

“Appendix B: Tested Storage Configuration (TSC) Creation” on page 57 contains the detailed information that describes how to create and configure the logical TSC.

SPC-1 Workload Generator Storage Configuration

Clause 9.2.4.5.3

The FDR must include all SPC-1 Workload Generator storage configuration commands and parameters.

The SPC-1 Workload Generator storage configuration commands and parameters for this measurement appear in “Appendix C: SPC-1 Workload Generator Storage Commands and Parameters” on page 67.

DATA REPOSITORY

Definitions

Total ASU Capacity: The total storage capacity read and written in the course of executing the SPC-1 benchmark.

Application Storage Unit (ASU): The logical interface between the storage and SPC-1 Workload Generator. The three ASUs (Data, User, and Log) are typically implemented on one or more Logical Volume.

Logical Volume: The division of Addressable Storage Capacity into individually addressable logical units of storage used in the SPC-1 benchmark. Each Logical Volume is implemented as a single, contiguous address space.

Addressable Storage Capacity: The total storage (sum of Logical Volumes) that can be read and written by application programs such as the SPC-1 Workload Generator.

Configured Storage Capacity: This capacity includes the Addressable Storage Capacity and any other storage (parity disks, hot spares, etc.) necessary to implement the Addressable Storage Capacity.

Physical Storage Capacity: The formatted capacity of all storage devices physically present in the Tested Storage Configuration (TSC).

Data Protection Overhead: The storage capacity required to implement the ECC data protection.

Required Storage: The amount of Configured Storage Capacity required to implement the Addressable Storage Configuration, excluding the storage required for the three ASUs.

Global Storage Overhead: The amount of Physical Storage Capacity that is required for storage subsystem use and unavailable for use by application programs.

Total Unused Storage: The amount of storage capacity available for use by application programs but not included in the Total ASU Capacity.

Storage Capacities and Relationships

Two tables and an illustration documenting the storage capacities and relationships of the SPC-1 Storage Hierarchy (Clause 2.1) shall be included in the FDR.

SPC-1 Storage Capacities

SPC-1 Storage Capacities		
Storage Hierarchy Component	Units	Capacity
Total ASU Capacity	Gigabytes (GB)	6,755.600
Addressable Storage Capacity	Gigabytes (GB)	6,957.847
Configured Storage Capacity	Gigabytes (GB)	32,985.349
Physical Storage Capacity	Gigabytes (GB)	37,584.829
Data Protection Overhead (mirror)	Gigabytes (GB)	16,492.674
Required Storage/Spares	Gigabytes (GB)	2,297.600
Global Storage Overhead	Gigabytes (GB)	2,301.880
Total Unused Storage	Gigabytes (GB)	9,879.192

SPC-1 Storage Hierarchy Ratios

	Addressable Storage Capacity	Configured Storage Capacity	Physical Storage Capacity
Total ASU Capacity	97.09%	20.48%	17.97%
Required for Data Protection (Mirroring)		50.00%	43.88%
Addressable Storage Capacity		21.09%	18.51%
Required Storage		6.97%	6.11%
Configured Storage Capacity			87.76%
Global Storage Overhead			6.12%
Unused Storage:			
Addressable	2.91%		
Configured		28.72%	
Physical			0.00%

The Physical Storage Capacity consisted of 37,584.829 GB distributed over 512 disk drives each with a formatted capacity of 73.408 GB. There was 0.000 GB (0.00%) of Unused Storage within the Physical Storage Capacity. Global Storage Overhead consisted of 2,301.880 GB (6.12%) of Physical Storage Capacity. There was 9,474.698 GB (28.72%) of Unused Storage within the Configured Storage Capacity. The Total ASU Capacity utilized 97.09% of the Addressable Storage Capacity resulting in 202.247 GB (2.91%) of Unused Storage within the Addressable Storage Capacity.

SPC-1 Storage Capacities and Relationships Illustration

The various storage capacities configured in the benchmark result are illustrated below (not to scale).

Logical Volume Capacity and ASU Mapping

Clause 9.2.4.6.2

A table illustrating the capacity of each ASU and the mapping of Logical Volumes to ASUs shall be provided in the FDR. ... Logical Volumes shall be sequenced in the table from top to bottom per its position in the contiguous address space of each ASU. The capacity of each Logical Volume shall be stated. ... In conjunction with this table, the Test Sponsor shall provide a complete description of the type of data protection (see Clause 2.4.5) used on each Logical Volume.

Logical Volume Capacity and Mapping		
ASU-1 (3,040.000 GB)	ASU-2 (3,040.000 GB)	ASU-3 (675.600 GB)
8 Logical Volumes 386.547 GB per Logical Volume (380.000 GB used per Logical Volume)	8 Logical Volumes 386.547 GB per Logical Volume (380.000 GB used per Logical Volume)	2 Logical Volumes 386.547 GB per Logical Volume (337.800 GB used per Logical Volume)

The Data Protection Level used for all Logical Volumes was Mirroring as described on page 10. See “ASU Configuration” in the [IOPS Test Results File](#) for more detailed configuration information.

SPC-1 BENCHMARK EXECUTION RESULTS

Definitions

Average Response Time: *The sum of the Response Times for all Measured I/O Requests divided by the total number of Measured I/O Requests.*

I/O Request Throughput: *The total number of Measured I/O requests in an SPC-1 Test Run divided by the duration of the Measurement Interval in seconds.*

Measurement Interval: *The finite and contiguous time period, after the Tested Storage Configuration (TSC) has reached Steady State, when data is collected by a Test Sponsor to generate an SPC-1 test result or support an SPC-1 test result.*

Steady State: *The consistent and sustainable throughput of the TSC. During this period the load presented to the TSC by the Workload Generator is constant. Comment: Steady Stated is achieved only after caches in the TSC have filled and as a result the I/O Request throughput of the TSC has stabilized.*

Test: *A collection of Test Phases or Test Runs sharing a common objective.*

Test Phase: *A collection of one or more SPC-1 Test Runs sharing a common objective and intended to be run in a specific sequence.*

Test Run: *The execution of SPC-1 for the purpose of producing or supporting an SPC-1 test result. SPC-1 Test Runs may have a finite and measured Ramp-Up period, Start-Up period, Shut-Down period, and Ramp-Down period as illustrated in the Figure 5-1 below. All SPC-1 Test Runs shall have a Steady State period and a Measurement Interval.*

The SPC-1 benchmark consists of the following Tests, Test Phases, and Test Runs:

- **Data Persistence Test**
 - Data Persistence Test Run 1
 - Data Persistence Test Run 2
- **Primary Metrics Test**
 - Sustainability Test Phase and Test Run
 - IOPS Test Phase and Test Run
 - Response Time Ramp Test Phase
 - 95% of IOPS Test Run
 - 90% of IOPS Test Run
 - 80% of IOPS Test Run
 - 50% of IOPS Test Run
 - 10% of IOPS Test Run (LRT)
- **Repeatability Test**
 - Repeatability Test Phase 1
 - 10% of IOPS Test Run (LRT)
 - IOPS Test Run
 - Repeatability Test Phase 2
 - 10% of IOPS Test Run (LRT)
 - IOPS Test Run

Each Test is an atomic unit that must be executed from start to finish before any other Test, Test Phase, or Test Run may be executed.

The results from each Test, Test Phase, and Test Run are listed below along with a more detailed explanation of each component.

Primary Metrics Test – Sustainability Test Phase

Clause 5.4.2.1

The Sustainability Test Phase consists of one Test Run at the 100% load point with a Measurement Interval of three (3) hours. The intent is to demonstrate a sustained maximum I/O Request Throughput as well as insuring the Tested Storage Configuration (TSC) has reached steady state prior to measuring the maximum I/O Request Throughput (SPC-1™ IOPS).

The reported I/O Request Throughput of the Sustainability Test Run must be within 5% of the reported SPC-1™ IOPS primary metric. The Average Response Time measured in Sustainability Test Run cannot exceed thirty (30) milliseconds.

Clause 9.2.4.7.1

For the Sustainability Test Phase the FDR shall contain:

- 1. A Data Rate Distribution graph and data table.*
- 2. I/O Request Throughput Distribution graph and data table.*
- 3. A Response Time Frequency Distribution graph and table.*
- 4. An Average Response Time Distribution graph and table.*
- 5. The human readable Test Run Results File produced by the Workload Generator (may be included in an appendix).*
- 6. A listing or screen image of all input parameters supplied to the Workload Generator (may be included in an appendix).*
- 7. The Measured Intensity Multiplier for each I/O stream.*
- 8. The variability of the Measured Intensity Multiplier, as defined in Clause 5.3.13.3.*

SPC-1 Workload Generator Input Parameters

The SPC-1 Workload Generator input parameters for the Sustainability, IOPS, Response Time Ramp, Repeatability, and Persistence Test Runs are documented in “Appendix D: SPC-1 Workload Generator Input Parameters” on Page 68.

Sustainability Test Results File

A link to the test results file generated from the Sustainability Test Run is listed below.

[Sustainability Test Results File](#)

Sustainability – Data Rate Distribution Data (MB/second)

Ramp-Up/Start-Up		Start	Stop	Interval	Duration															
Measurement Interval		19:13:49	19:16:49	0-2	0:03:00															
		19:16:49	22:16:49	3-182	3:00:00															
Interval	All ASUs	ASU1	ASU2	ASU3	Interval	All ASUs	ASU1	ASU2	ASU3	Interval	All ASUs	ASU1	ASU2	ASU3						
0	832.90	323.08	89.01	420.81	63	844.23	327.87	90.00	426.36	126	829.95	322.61	88.46	418.87						
1	829.19	321.94	88.82	418.43	64	830.20	322.26	88.49	419.45	127	830.00	322.08	88.53	419.40						
2	829.69	322.19	88.41	419.09	65	830.42	321.96	88.72	419.74	128	830.53	322.47	88.79	419.27						
3	830.70	322.47	88.82	419.40	66	830.01	321.92	88.87	419.23	129	830.53	322.51	88.70	419.32						
4	829.83	321.89	88.72	419.22	67	816.89	317.27	87.14	412.48	130	830.04	322.24	88.96	418.84						
5	830.70	322.33	88.98	419.39	68	844.18	327.60	90.04	426.54	131	829.90	322.17	88.82	418.90						
6	829.56	322.30	88.56	418.70	69	830.22	322.37	89.05	418.81	132	831.44	322.31	88.94	420.20						
7	830.54	322.30	88.74	419.50	70	830.73	322.40	88.91	419.42	133	831.09	322.42	88.77	419.90						
8	829.46	322.13	88.79	418.55	71	829.59	322.12	88.97	418.51	134	829.29	322.25	88.53	418.51						
9	829.90	322.03	88.30	419.57	72	829.72	322.14	88.49	419.10	135	829.58	322.14	88.50	418.94						
10	829.67	322.10	88.60	418.98	73	830.87	322.61	88.64	419.62	136	829.72	322.03	88.63	419.06						
11	831.19	322.65	88.65	419.89	74	830.05	322.60	88.67	418.78	137	830.77	322.39	88.84	419.54						
12	830.02	322.59	88.98	418.45	75	830.32	322.32	88.85	419.15	138	829.14	321.78	88.88	418.49						
13	829.36	322.36	88.41	418.59	76	829.60	322.06	88.33	419.20	139	829.99	322.25	88.55	419.20						
14	829.86	322.26	88.92	418.69	77	830.14	322.28	88.77	419.08	140	829.07	321.77	88.49	418.81						
15	830.01	322.16	88.74	419.12	78	830.41	322.28	88.55	419.58	141	830.11	322.33	88.55	419.23						
16	830.98	322.73	88.84	419.41	79	830.09	322.44	88.68	418.97	142	828.94	322.07	88.61	418.26						
17	830.10	322.37	88.89	418.84	80	830.73	322.43	88.51	419.79	143	830.98	322.80	88.93	419.26						
18	830.03	322.43	88.86	418.74	81	828.79	322.16	88.47	418.16	144	822.95	319.23	87.92	415.80						
19	826.89	320.65	88.50	417.74	82	829.11	322.02	88.38	418.71	145	822.87	319.65	87.95	415.27						
20	833.06	323.73	89.02	420.31	83	828.94	322.23	88.45	418.26	146	826.12	320.68	88.37	417.07						
21	831.69	322.42	88.84	420.43	84	829.77	322.26	88.81	418.71	147	795.55	308.68	84.96	401.91						
22	830.41	322.20	88.33	419.88	85	830.69	322.35	88.51	419.83	148	815.18	316.24	87.03	411.92						
23	831.12	322.17	88.74	420.21	86	829.68	322.49	88.42	418.77	149	853.68	331.02	90.98	431.68						
24	831.59	322.22	88.98	420.39	87	831.39	322.58	88.82	419.99	150	855.59	332.03	91.60	431.95						
25	829.36	321.76	88.55	419.05	88	829.34	321.84	88.52	418.97	151	850.24	329.84	90.76	429.64						
26	829.91	322.29	88.86	418.76	89	829.94	322.12	88.59	419.23	152	830.12	322.40	88.66	419.07						
27	829.17	322.03	88.72	418.43	90	829.52	322.22	88.39	418.91	153	829.15	321.50	88.74	418.90						
28	830.28	322.23	88.85	419.20	91	830.77	322.29	88.72	419.76	154	830.52	322.23	88.59	419.70						
29	828.80	321.77	88.43	418.61	92	829.39	321.67	88.73	418.99	155	830.39	321.99	88.53	419.87						
30	829.73	322.02	88.60	419.11	93	831.21	322.87	88.57	419.77	156	826.88	320.87	88.21	417.80						
31	829.84	322.03	88.46	419.35	94	830.03	322.53	88.63	418.86	157	832.42	323.48	89.08	419.86						
32	829.99	322.53	88.69	418.77	95	830.86	322.53	88.55	419.78	158	829.07	321.50	88.62	418.95						
33	829.95	321.73	88.36	419.85	96	830.19	322.45	88.54	419.20	159	831.13	322.63	88.65	419.85						
34	830.08	322.02	88.49	419.56	97	829.94	321.94	88.61	419.39	160	828.51	321.96	88.05	418.51						
35	830.41	322.14	88.64	419.62	98	830.05	322.53	88.72	418.80	161	829.85	322.25	88.38	419.21						
36	826.54	320.97	88.34	417.23	99	830.32	322.24	89.09	419.00	162	830.45	322.48	88.47	419.50						
37	833.50	323.82	89.09	420.59	100	829.16	321.84	88.63	418.68	163	830.45	322.59	88.98	418.89						
38	828.79	321.83	88.36	418.59	101	829.53	322.10	88.82	418.61	164	829.28	321.75	88.66	418.88						
39	830.97	322.67	88.43	419.87	102	830.86	322.43	88.82	419.62	165	829.95	322.56	88.76	418.63						
40	829.72	322.24	88.43	419.05	103	828.65	322.05	88.56	418.05	166	829.01	322.13	88.98	417.90						
41	829.44	321.99	88.54	418.91	104	829.93	321.90	88.63	419.40	167	830.61	322.33	88.73	419.55						
42	830.84	322.32	88.69	419.82	105	829.81	322.57	88.65	418.59	168	830.42	322.55	88.62	419.25						
43	830.25	322.45	88.32	419.48	106	830.71	322.82	88.91	418.98	169	830.25	321.76	88.63	419.87						
44	829.82	322.07	88.78	418.97	107	830.78	322.19	88.92	419.67	170	829.68	322.20	88.38	419.09						
45	830.59	322.98	88.81	418.80	108	829.15	322.10	88.34	418.71	171	830.52	322.41	88.55	419.56						
46	829.54	322.12	88.47	418.95	109	829.92	322.76	88.26	418.90	172	830.69	322.37	88.51	419.82						
47	831.23	323.05	88.46	419.72	110	830.02	321.87	88.56	419.59	173	830.01	322.12	88.67	419.22						
48	830.00	322.43	88.50	419.07	111	829.89	322.10	88.93	418.86	174	829.01	322.03	88.69	418.29						
49	829.44	321.81	88.68	418.96	112	830.72	322.53	88.61	419.57	175	830.60	322.25	88.52	419.83						
50	829.70	321.92	88.62	419.16	113	830.09	321.68	88.80	419.61	176	830.16	322.56	88.74	418.86						
51	830.26	322.59	88.57	419.10	114	830.08	322.03	88.50	419.55	177	829.82	322.42	88.55	418.85						
52	829.56	322.69	88.48	418.40	115	829.66	321.95	88.53	419.18	178	830.03	321.98	88.84	419.21						
53	813.96	316.19	86.96	410.81	116	830.44	322.62	88.43	419.39	179	830.33	322.44	88.95	418.93						
54	789.72	306.99	84.11	398.63	117	829.50	322.57	88.61	418.32	180	831.34	322.13	89.01	420.21						
55	787.47	305.74	83.96	397.78	118	829.83	322.25	88.70	418.88	181	830.47	322.22	88.74	419.51						
56	792.17	307.41	84.73	400.03	119	830.56	322.69	88.80	419.07	182	830.80	322.33	88.89	419.58						
57	840.80	326.42	89.87	424.50	120	829.78	322.06	88.26	419.46											
58	850.02	330.12	90.81	429.09	121	829.44	322.00	88.63	418.81											
59	850.69	330.32	90.73	429.64	122	829.23	321.84	88.37	419.03											
60	851.48	330.21	91.04	430.23	123	830.12	322.61	88.42	419.10											
61	856.52	332.45	91.64	432.43	124	830.35	322.26	88.68	419.41											
62	856.32	332.18	91.61	432.53	125	830.20	322.09	88.76	419.35											

Sustainability – Data Rate Distribution Graph

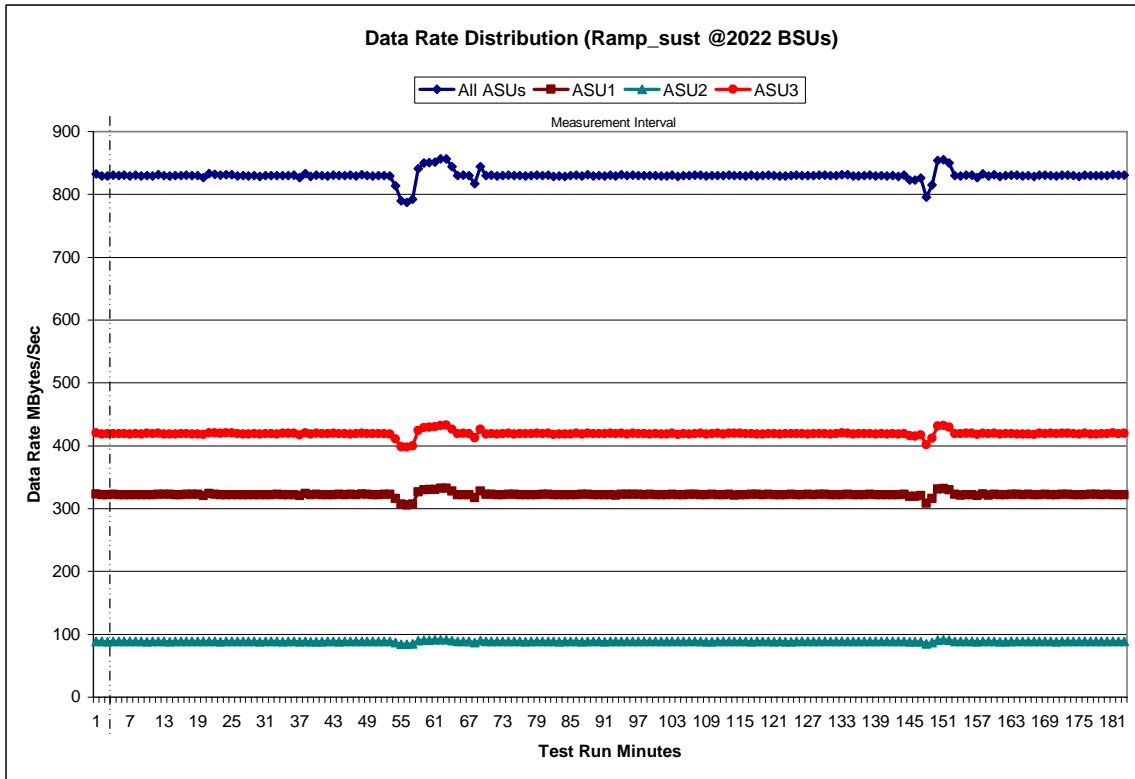

Sustainability – I/O Request Throughput Distribution Data

Ramp-Up/Start-Up Measurement Interval		Start	Stop	Interval	Duration										
		19:13:49	19:16:49	0-2	0:03:00										
		19:16:49	22:16:49	3-182	3:00:00										
Interval	All ASUs	ASU1	ASU2	ASU3	Interval	All ASUs	ASU1	ASU2	ASU3	Interval	All ASUs	ASU1	ASU2	ASU3	
0	101,328.05	60,368.73	12,496.18	28,463.13	63	102,920.75	61,336.23	12,651.33	28,933.18	126	101,066.55	60,293.45	12,401.05	28,372.05	
1	101,075.52	60,241.45	12,431.35	28,402.72	64	101,120.92	60,279.62	12,399.38	28,441.92	127	101,129.20	60,261.38	12,445.82	28,422.00	
2	101,044.62	60,207.07	12,432.82	28,404.73	65	101,093.88	60,240.45	12,424.10	28,429.33	128	101,098.48	60,268.10	12,418.25	28,412.13	
3	101,086.20	60,217.38	12,447.75	28,421.07	66	101,137.63	60,234.47	12,467.78	28,435.38	129	101,110.30	60,292.22	12,420.12	28,397.97	
4	101,077.93	60,223.30	12,446.43	28,408.20	67	99,432.95	59,273.02	12,218.18	27,941.75	130	101,030.98	60,226.28	12,421.23	28,383.47	
5	101,155.38	60,280.52	12,456.32	28,418.55	68	102,699.43	61,195.15	12,644.45	28,859.83	131	101,028.53	60,218.45	12,434.73	28,375.35	
6	101,115.57	60,279.93	12,439.15	28,396.48	69	101,090.18	60,246.45	12,453.28	28,390.45	132	101,184.42	60,292.25	12,445.88	28,446.28	
7	101,136.55	60,273.93	12,434.68	28,427.93	70	101,156.45	60,251.43	12,477.97	28,427.05	133	101,074.05	60,244.08	12,420.38	28,409.58	
8	101,081.42	60,251.27	12,423.38	28,406.77	71	101,141.30	60,277.05	12,456.95	28,407.30	134	101,104.25	60,273.77	12,423.40	28,407.08	
9	101,084.43	60,247.85	12,438.48	28,398.10	72	101,100.83	60,267.45	12,439.38	28,394.00	135	101,075.93	60,255.60	12,423.75	28,396.58	
10	101,084.65	60,236.63	12,418.28	28,429.73	73	101,174.37	60,289.02	12,437.58	28,447.77	136	101,064.60	60,197.17	12,440.17	28,427.27	
11	101,163.40	60,294.22	12,430.12	28,439.07	74	101,090.07	60,249.57	12,444.60	28,395.90	137	101,083.07	60,251.00	12,419.03	28,413.03	
12	101,068.28	60,244.50	12,454.22	28,369.57	75	101,125.63	60,268.17	12,455.27	28,402.20	138	101,059.42	60,208.32	12,435.40	28,415.70	
13	101,104.40	60,271.23	12,447.93	28,385.23	76	101,111.38	60,252.10	12,431.68	28,427.60	139	101,059.40	60,243.98	12,408.12	28,407.30	
14	101,098.50	60,296.13	12,431.88	28,370.48	77	101,112.45	60,297.83	12,429.10	28,385.52	140	101,018.72	60,217.87	12,424.93	28,375.92	
15	101,137.10	60,284.43	12,440.98	28,411.68	78	101,077.78	60,238.28	12,420.62	28,418.88	141	101,113.48	60,271.83	12,436.45	28,405.20	
16	101,166.30	60,300.78	12,446.55	28,418.97	79	101,112.25	60,284.15	12,440.40	28,387.70	142	101,096.60	60,294.67	12,440.13	28,361.80	
17	101,134.53	60,284.72	12,445.98	28,403.83	80	101,134.78	60,256.45	12,454.90	28,423.43	143	101,144.72	60,290.32	12,441.30	28,413.10	
18	101,097.90	60,273.95	12,442.13	28,381.82	81	101,095.33	60,277.83	12,421.82	28,395.68	144	100,291.70	59,750.08	12,336.45	28,205.17	
19	100,626.00	59,965.43	12,380.70	28,279.87	82	101,037.63	60,213.32	12,412.93	28,411.38	145	100,217.93	59,755.75	12,331.87	28,130.32	
20	101,590.92	60,569.67	12,500.67	28,520.58	83	101,106.88	60,275.90	12,435.12	28,395.87	146	100,660.37	59,799.45	12,376.20	28,304.72	
21	101,121.18	60,253.55	12,450.98	28,416.65	84	101,067.60	60,218.47	12,462.82	28,386.32	147	96,851.87	57,714.62	11,903.65	27,233.60	
22	101,133.20	60,258.70	12,425.47	28,449.03	85	101,141.78	60,266.72	12,441.15	28,433.92	148	99,290.47	59,151.90	12,205.93	27,932.63	
23	101,132.13	60,275.22	12,436.65	28,420.27	86	101,140.63	60,263.35	12,441.52	28,435.77	149	103,764.63	61,837.27	12,744.27	29,183.10	
24	101,119.65	60,228.72	12,447.80	28,443.13	87	101,158.93	60,264.70	12,431.98	28,462.25	150	104,131.43	62,049.58	12,840.05	29,241.80	
25	100,978.78	60,190.42	12,417.50	28,370.87	88	101,076.97	60,247.15	12,428.38	28,401.43	151	103,511.13	61,689.83	12,741.95	29,079.35	
26	101,156.43	60,326.88	12,445.63	28,383.92	89	101,096.33	60,238.30	12,442.73	28,415.30	152	101,077.27	60,261.13	12,447.18	28,368.95	
27	101,113.28	60,267.28	12,456.27	28,389.73	90	101,086.50	60,241.32	12,433.40	28,411.78	153	101,012.28	60,203.10	12,420.17	28,389.02	
28	101,098.57	60,253.50	12,453.33	28,391.73	91	101,121.62	60,281.38	12,423.30	28,416.93	154	101,093.17	60,256.90	12,419.42	28,416.85	
29	101,099.13	60,212.35	12,436.73	28,450.05	92	101,101.48	60,203.25	12,441.82	28,456.42	155	101,113.70	60,253.17	12,434.50	28,426.03	
30	101,031.38	60,185.53	12,421.50	28,424.35	93	101,194.95	60,331.48	12,443.47	28,420.00	156	100,768.40	60,051.73	12,393.85	28,322.82	
31	101,091.12	60,267.78	12,419.08	28,404.25	94	101,134.98	60,271.75	12,455.02	28,408.22	157	101,393.53	60,454.62	12,489.75	28,449.17	
32	101,104.23	60,275.92	12,455.03	28,373.28	95	101,100.10	60,259.42	12,420.18	28,420.50	158	101,028.95	60,192.28	12,418.92	28,417.75	
33	101,126.60	60,263.57	12,416.17	28,446.87	96	101,095.03	60,247.38	12,417.25	28,430.40	159	101,162.02	60,293.67	12,437.27	28,431.08	
34	101,020.95	60,197.40	12,417.13	28,406.42	97	101,130.33	60,272.58	12,447.93	28,409.82	160	101,028.98	60,226.90	12,406.47	28,395.62	
35	101,102.75	60,216.95	12,445.48	28,440.32	98	101,090.57	60,277.82	12,425.02	28,387.73	161	101,012.52	60,191.48	12,412.30	28,408.73	
36	100,669.32	60,011.32	12,384.57	28,273.43	99	101,094.33	60,256.87	12,434.35	28,403.12	162	101,154.92	60,300.18	12,426.03	28,428.70	
37	101,623.98	60,592.18	12,490.67	28,541.13	100	101,107.30	60,286.52	12,434.48	28,386.30	163	101,080.78	60,254.13	12,434.40	28,392.25	
38	100,984.52	60,196.63	12,403.62	28,384.27	101	101,118.85	60,249.07	12,464.57	28,405.22	164	101,076.32	60,209.47	12,451.85	28,415.00	
39	101,117.92	60,285.17	12,395.85	28,436.90	102	101,140.02	60,290.23	12,439.57	28,410.22	165	101,134.15	60,297.43	12,445.17	28,391.55	
40	101,116.28	60,248.65	12,424.78	28,442.85	103	101,092.47	60,302.77	12,422.90	28,366.80	166	101,109.07	60,290.42	12,449.70	28,368.95	
41	101,083.65	60,245.78	12,450.30	28,387.57	104	101,026.73	60,185.05	12,431.13	28,410.55	167	101,087.92	60,235.32	12,450.45	28,402.15	
42	101,100.02	60,246.80	12,417.82	28,435.40	105	101,141.30	60,267.22	12,459.35	28,414.73	168	101,140.05	60,283.47	12,447.83	28,408.75	
43	101,105.93	60,257.40	12,412.28	28,436.25	106	101,165.42	60,316.08	12,433.22	28,416.12	169	101,073.63	60,207.73	12,431.47	28,434.43	
44	101,064.25	60,228.53	12,438.33	28,397.38	107	101,138.12	60,273.17	12,450.73	28,414.22	170	101,031.53	60,248.47	12,386.15	28,396.92	
45	101,103.08	60,299.18	12,422.30	28,381.60	108	101,022.33	60,224.83	12,421.22	28,376.28	171	101,161.03	60,301.60	12,431.80	28,427.63	
46	101,115.68	60,295.50	12,420.20	28,399.98	109	101,156.75	60,336.75	12,437.83	28,382.17	172	101,085.32	60,241.53	12,424.62	28,419.17	
47	101,172.72	60,321.85	12,428.45	28,422.42	110	101,092.25	60,258.58	12,421.80	28,411.87	173	101,078.95	60,246.20	12,421.62	28,411.13	
48	101,110.62	60,264.80	12,435.50	28,410.32	111	101,033.93	60,217.43	12,450.40	28,366.10	174	101,046.80	60,244.07	12,422.97	28,379.77	
49	101,059.83	60,217.58	12,440.08	28,402.17	112	101,101.72	60,269.72	12,419.27	28,412.73	175	101,121.13	60,259.43	12,419.18	28,442.52	
50	101,075.90	60,218.82	12,427.63	28,429.45	113	101,074.87	60,217.17	12,431.20	28,426.50	176	101,134.05	60,279.05	12,455.17	28,399.83	
51	101,093.33	60,255.75	12,435.85	28,401.73	114	101,070.95	60,247.05	12,434.03	28,389.87	177	101,064.98	60,241.40	12,414.95	28,408.63	
52	101,087.00	60,248.50	12,426.25	28,412.25	115	101,049.12	60,205.93	12,420.00	28,423.18	178	101,104.55	60,276.15	12,422.90	28,405.50	
53	99,187.05	59,127.53	12,203.38	27,856.13	116	101,210.10	60,334.07	12,442.10	28,433.93	179	101,067.93	60,237.75	12,440.27	28,389.92	
54	96,119.35	57,301.18	11,803.92	27,014.25	117	101,125.80	60,283.83	12,436.18	28,405.78	180	101,153.90	60,288.52	12,453.35	28,412.03	
55	95,905.22	57,142.20	11,786.50	26,976.52	118	101,100.70	60,244.85	12,424.58	28,431.27	181	101,096.75	60,242.93	12,418.22	28,435.60	
56	96,489.30	57,518.87	11,866.08	27,104.35	119	101,158.12	60,306.28	12,448.30	28,403.53	182	101,107.15	60,233.65	12,449.33	28,424.17	
57	102,441.27	61,084.30	12,598.78	28,758.18	120	101,110.47	60,250.03	12,422.38	28,438.05	Average	101,101.40	60,257.51	12,434.22	28,409.67	
58	103,610.10	61,756.42	12,739.13	29,114.55	121	101,068.27	60,246.92	12,441.27	28,380.08						
59	103,528.35	61,704.05	12,724.00	29,100.30	122	100,972.15	60,165.58	12,419.02	28,387.55						
60	103,774.03	61,846.92	1												

Sustainability – I/O Request Throughput Distribution Graph

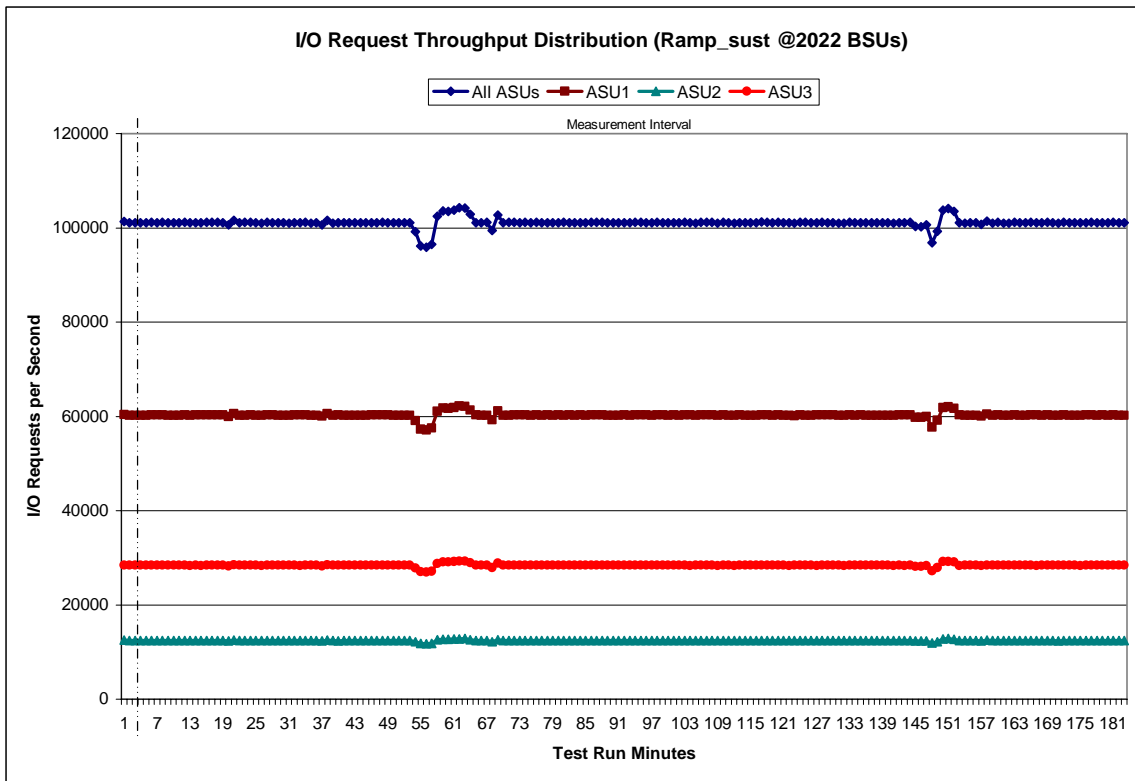

Sustainability – Average Response Time (ms) Distribution Data

Ramp-Up/Start-Up Measurement Interval		Start 19:13:49	Stop 19:16:49	Interval 0-2 3-182	Duration 0:03:00 3:00:00															
Interval	All ASUs	ASU1	ASU2	ASU3	Interval	All ASUs	ASU1	ASU2	ASU3	Interval	All ASUs	ASU1	ASU2	ASU3						
0	6.79	6.74	7.66	6.51	63	18.26	17.58	18.43	19.65	126	9.18	9.11	9.81	9.07						
1	7.55	7.38	8.14	7.65	64	9.31	9.18	9.82	9.38	127	10.46	10.35	11.07	10.45						
2	7.68	7.57	8.27	7.64	65	10.49	10.35	10.93	10.60	128	10.20	10.09	10.71	10.19						
3	9.94	9.60	10.47	10.41	66	11.67	11.44	12.05	11.98	129	9.33	9.36	9.92	9.02						
4	9.51	9.24	10.01	9.86	67	11.75	11.64	12.33	11.75	130	9.65	9.61	10.21	9.51						
5	9.33	9.10	9.77	9.63	68	28.08	27.18	28.19	29.94	131	9.38	9.32	9.90	9.27						
6	10.95	10.57	11.37	11.55	69	9.18	9.17	9.62	9.02	132	9.84	9.81	10.30	9.70						
7	9.99	9.78	10.36	10.26	70	16.81	16.78	16.45	17.03	133	10.85	10.77	11.35	10.80						
8	9.39	9.20	9.82	9.60	71	10.63	10.47	10.84	10.88	134	10.30	10.19	10.87	10.28						
9	11.24	10.88	11.63	11.84	72	9.31	9.20	9.78	9.35	135	8.70	8.65	9.23	8.57						
10	8.75	8.60	9.24	8.86	73	8.44	8.37	9.07	8.29	136	8.33	8.35	8.95	8.01						
11	9.81	9.60	10.23	10.07	74	9.85	9.73	10.26	9.92	137	8.41	8.41	9.02	8.14						
12	10.80	10.53	11.23	11.17	75	9.89	9.77	10.43	9.88	138	9.87	9.84	10.51	9.64						
13	11.74	11.38	12.17	12.30	76	10.41	10.26	10.84	10.56	139	11.08	10.95	11.49	11.16						
14	9.36	9.18	9.83	9.54	77	9.90	9.81	10.31	9.90	140	10.84	10.69	11.26	10.96						
15	9.16	8.99	9.62	9.30	78	10.34	10.18	10.78	10.49	141	8.91	8.84	9.43	8.84						
16	8.96	8.81	9.42	9.06	79	9.81	9.75	10.22	9.76	142	9.44	9.40	9.97	9.28						
17	8.80	8.69	9.31	8.81	80	9.11	9.06	9.66	8.99	143	14.96	14.81	14.96	15.26						
18	7.86	7.80	8.40	7.77	81	9.13	9.06	9.63	9.04	144	33.89	32.66	31.11	37.71						
19	24.66	24.35	24.80	25.24	82	10.95	10.76	11.34	11.18	145	32.96	31.22	30.85	37.59						
20	20.36	19.97	20.83	21.00	83	13.35	13.09	13.69	13.73	146	33.36	32.03	32.78	36.45						
21	17.17	16.79	17.73	17.72	84	7.24	7.33	7.86	6.77	147	34.37	33.74	31.70	36.87						
22	9.21	9.04	9.67	9.37	85	7.43	7.53	8.08	6.93	148	33.67	33.09	32.39	35.48						
23	11.50	11.33	12.07	11.62	86	8.48	8.47	8.99	8.28	149	34.72	34.91	32.85	35.16						
24	9.39	9.23	9.78	9.57	87	9.24	9.16	9.66	9.22	150	31.93	31.56	31.21	33.02						
25	10.62	10.37	10.92	11.02	88	9.15	9.08	9.62	9.08	151	22.65	22.77	22.99	22.24						
26	8.83	8.74	9.30	8.82	89	9.95	9.90	10.38	9.87	152	10.39	10.37	10.94	10.18						
27	9.51	9.39	9.86	9.64	90	9.73	9.61	10.21	9.77	153	7.96	8.07	8.73	7.38						
28	10.79	10.60	11.16	11.02	91	11.55	11.32	11.94	11.89	154	10.83	10.71	11.39	10.86						
29	10.93	10.73	11.24	11.21	92	11.23	11.03	11.53	11.52	155	8.94	8.93	9.59	8.67						
30	8.93	8.79	9.27	9.06	93	9.72	9.63	10.10	9.77	156	20.33	20.74	20.35	19.47						
31	10.42	10.16	10.71	10.84	94	9.47	9.50	9.99	9.17	157	15.23	15.25	15.73	14.98						
32	10.29	10.14	10.58	10.49	95	9.31	9.32	9.76	9.10	158	8.97	9.00	9.58	8.63						
33	9.60	9.60	10.01	9.41	96	18.28	17.41	17.89	20.27	159	11.58	11.44	12.03	11.69						
34	9.65	9.56	10.05	9.67	97	9.14	9.09	9.70	9.02	160	8.47	8.51	9.15	8.10						
35	9.80	9.71	10.26	9.79	98	10.59	10.46	11.02	10.68	161	10.04	9.93	10.54	10.08						
36	20.12	19.63	19.90	21.24	99	10.05	10.02	10.49	9.91	162	10.49	10.39	10.96	10.52						
37	11.30	11.18	11.49	11.46	100	9.12	9.11	9.49	8.99	163	10.08	10.06	10.68	9.85						
38	9.42	9.39	9.83	9.32	101	9.63	9.54	10.01	9.65	164	10.63	10.61	11.20	10.43						
39	9.20	9.13	9.65	9.16	102	9.72	9.62	10.08	9.76	165	10.62	10.60	11.13	10.42						
40	9.30	9.22	9.78	9.26	103	12.19	11.99	12.51	12.46	166	10.69	10.66	11.24	10.50						
41	10.63	10.44	10.95	10.88	104	9.03	8.99	9.52	8.90	167	9.35	9.39	10.00	8.98						
42	10.06	9.93	10.50	10.13	105	7.86	7.91	8.44	7.50	168	10.00	9.93	10.61	9.87						
43	9.54	9.50	9.98	9.43	106	9.69	9.64	10.20	9.59	169	9.34	9.30	9.93	9.16						
44	10.03	9.95	10.45	10.00	107	9.65	9.65	10.18	9.41	170	10.09	9.99	10.60	10.07						
45	9.75	9.65	10.11	9.80	108	11.91	11.68	12.24	12.25	171	11.15	10.96	11.64	11.33						
46	9.54	9.39	9.88	9.69	109	9.54	9.48	10.07	9.42	172	8.67	8.74	9.34	8.23						
47	9.60	9.48	9.94	9.72	110	11.36	11.19	11.86	11.51	173	18.92	18.61	19.10	19.52						
48	9.29	9.23	9.73	9.23	111	10.46	10.32	10.90	10.55	174	12.21	12.02	12.62	12.45						
49	9.28	9.17	9.67	9.35	112	10.06	9.96	10.53	10.06	175	11.17	11.13	11.66	11.03						
50	10.57	10.31	10.94	10.97	113	16.30	16.25	16.52	16.31	176	14.13	14.00	14.33	14.31						
51	10.55	10.29	10.89	10.98	114	10.15	10.06	10.68	10.09	177	13.08	13.04	13.42	13.01						
52	11.37	11.15	11.72	11.69	115	13.29	13.10	13.52	13.58	178	14.69	14.59	15.04	14.76						
53	30.17	28.03	28.68	35.37	116	13.26	13.16	13.63	13.34	179	14.11	14.02	14.46	14.15						
54	37.51	34.55	36.14	44.41	117	16.22	16.12	16.38	16.36	180	14.14	13.92	14.35	14.51						
55	39.74	37.61	40.00	44.16	118	11.77	11.76	12.37	11.54	181	14.16	13.92	14.42	14.57						
56	40.66	39.31	40.01	43.82	119	12.06	11.96	12.61	12.04	182	13.34	13.18	13.66	13.54						
57	37.50	36.15	37.87	40.19	120	10.14	10.07	10.85	9.97	Average	13.22	13.00	13.51	13.58						
58	36.85	35.07	35.97	41.00	121	11.37	11.31	11.89	11.28											
59	35.57	34.74	35.93	37.17	122	10.11	10.04	10.67	10.00											
60	33.27	32.59	33.59	34.59	123	11.43	11.28	11.90	11.53											
61	30.48	29.40	28.45	33.65	124	9.16	9.12	9.83	8.95											
62	28.32	27.45	26.20	31.09	125	9.82	9.79	10.35	9.67											

Sustainability – Average Response Time (ms) Distribution Graph

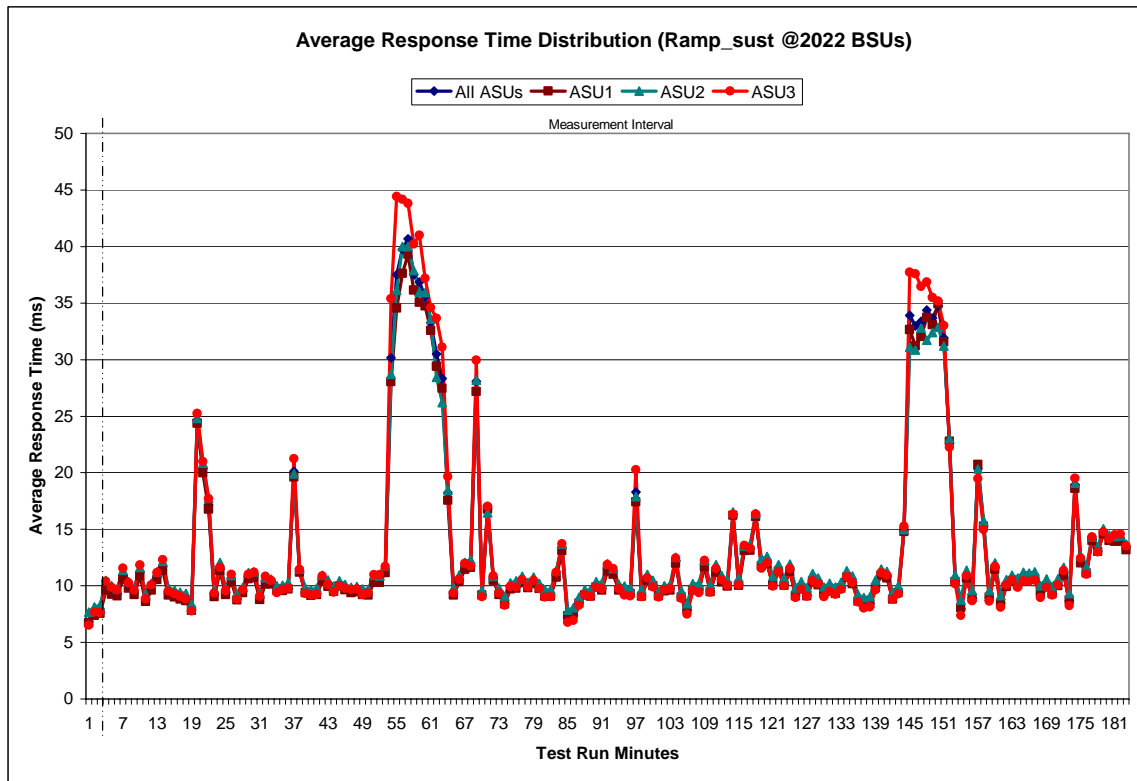

Sustainability – Response Time Frequency Distribution Data

Response Time (ms)	0-0.25	>0.25-0.5	>0.5-0.75	>0.75-1.0	>1.0-1.25	>1.25-1.5	>1.5-1.75	>1.75-2.0
Read	3,790,002	33,514,124	18,047,702	14,600,940	12,515,300	10,958,985	9,772,413	8,914,114
Write	-	26,753,836	45,025,702	36,683,452	32,084,301	28,231,257	24,736,069	21,977,360
All ASUs	3,790,002	60,267,960	63,073,404	51,284,392	44,599,601	39,190,242	34,508,482	30,891,474
ASU1	3,420,538	44,049,825	36,188,095	28,586,956	24,430,294	21,436,775	18,949,181	17,054,537
ASU2	369,464	7,643,190	7,367,832	5,771,546	4,899,361	4,303,676	3,798,686	3,413,901
ASU3	-	8,574,945	19,517,477	16,925,890	15,269,946	13,449,791	11,760,615	10,423,036
Response Time (ms)	>2.0-2.5	>2.5-3.0	>3.0-3.5	>3.5-4.0	>4.0-4.5	>4.5-5.0	>5.0-6.0	>6.0-7.0
Read	16,319,259	15,411,559	14,987,962	14,607,900	14,236,674	13,887,532	26,212,242	22,797,490
Write	38,198,951	34,044,631	32,055,518	30,508,603	28,758,656	26,882,363	47,481,217	37,832,499
All ASUs	54,518,210	49,456,190	47,043,480	45,116,503	42,995,330	40,769,895	73,693,459	60,629,989
ASU1	30,459,952	28,061,008	26,937,022	25,957,080	24,836,896	23,673,916	43,092,411	35,739,322
ASU2	6,064,644	5,572,510	5,371,819	5,215,901	5,036,800	4,847,045	8,937,512	7,528,202
ASU3	17,993,614	15,822,672	14,734,639	13,943,522	13,121,634	12,248,934	21,663,536	17,362,465
Response Time (ms)	>7.0-8.0	>8.0-9.0	>9.0-10.0	>10.0-15.0	>15.0-20.0	>20.0-25.0	>25.0-30.0	>30.0
Read	18,753,817	15,115,234	12,576,104	44,149,604	25,576,613	15,265,256	9,920,523	38,501,501
Write	28,003,803	20,192,386	14,955,432	36,153,957	14,125,283	8,471,115	6,115,130	42,189,309
All ASUs	46,757,620	35,307,620	27,531,536	80,303,561	39,701,896	23,736,371	16,035,653	80,690,810
ASU1	27,848,348	21,288,298	16,833,672	51,403,976	26,605,829	15,848,103	10,550,224	47,527,982
ASU2	5,924,147	4,565,733	3,631,460	11,371,557	6,037,294	3,633,730	2,423,133	10,560,215
ASU3	12,985,125	9,453,589	7,066,404	17,528,028	7,058,773	4,254,538	3,062,296	22,602,613

Sustainability – Response Time Frequency Distribution Graph

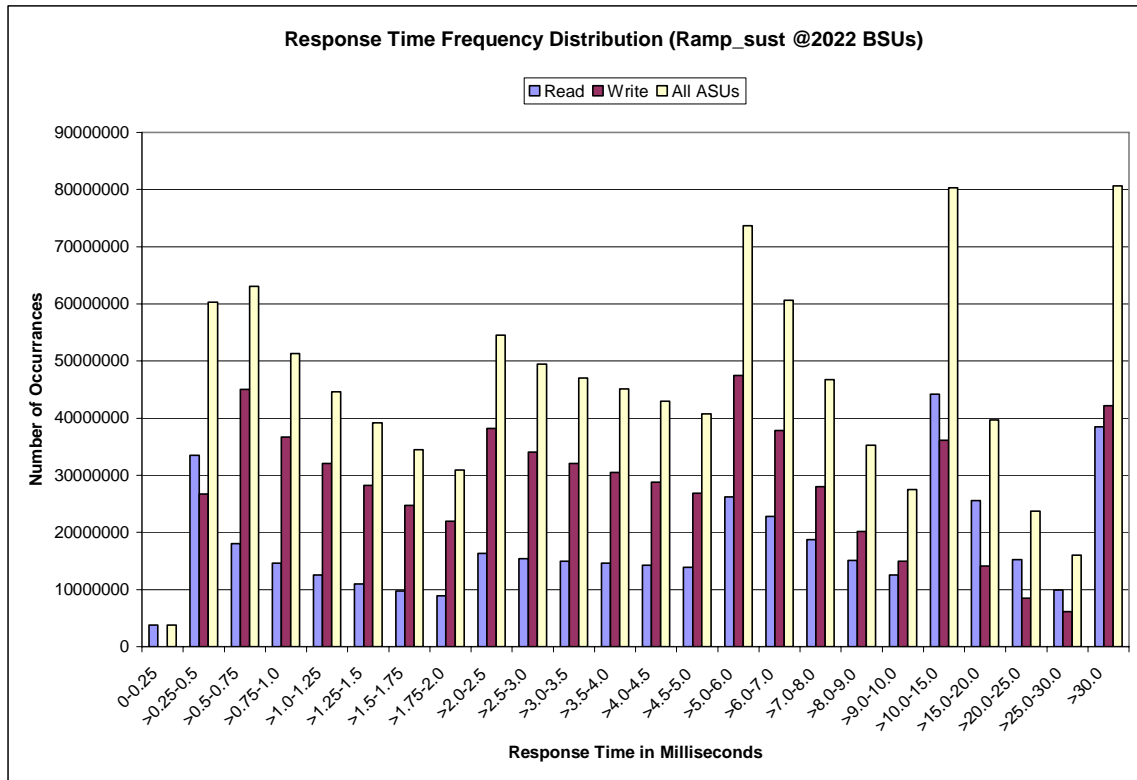

Sustainability – Measured Intensity Multiplier and Coefficient of Variation

	ASU1-1	ASU1-2	ASU1-3	ASU1-4	ASU2-1	ASU2-2	ASU2-3	ASU3-1
IM	0.0350	0.2810	0.0700	0.2100	0.0180	0.0700	0.0350	0.2810
MIM	0.0350	0.2810	0.0700	0.2100	0.0180	0.0700	0.0350	0.2810
COV	0.002	0.001	0.001	0.001	0.003	0.001	0.002	0.001

Clause 3.4.3

IM – Intensity Multiplier: The ratio of I/Os for each I/O stream relative to the total I/Os for all I/O streams (ASU1-1 – ASU3-1) as required by the benchmark specification.

Clauses 5.1.0 and 5.3.13.2

MIM – Measured Intensity Multiplier: The Measured Intensity Multiplier represents the ratio of measured I/Os for each I/O stream relative to the total I/Os measured for all I/O streams (ASU1-1 – ASU3-1). This value may differ from the corresponding Expected Intensity Multiplier by no more than 5%.

Clause 5.3.13.3

COV – Coefficient of Variation: This measure of variation for the Measured Intensity Multiplier cannot exceed 0.2.

Primary Metrics Test – IOPS Test Phase

Clause 5.4.2.2

The IOPS Test Phase consists of one Test Run at the 100% load point with a Measurement Interval of ten (10) minutes. The IOPS Test Phase immediately follows the Sustainability Test Phase without any interruption or manual intervention.

The IOPS Test Run generates the SPC-1 IOPS™ primary metric, which is computed as the I/O Request Throughput for the Measurement Interval of the IOPS Test Run.

The Average Response Time is computed for the IOPS Test Run and cannot exceed 30 milliseconds. If the Average Response Time exceeds the 30 millisecond constraint, the measurement is invalid.

Clause 9.2.4.7.2

For the IOPS Test Phase the FDR shall contain:

- 1. I/O Request Throughput Distribution (data and graph).*
- 2. A Response Time Frequency Distribution.*
- 3. An Average Response Time Distribution.*
- 4. The human readable Test Run Results File produced by the Workload Generator.*
- 5. A listing or screen image of all input parameters supplied to the Workload Generator.*
- 6. The total number of I/O Requests completed in the Measurement Interval as well as the number of I/O Requests with a Response Time less than or equal to 30 milliseconds and the number of I/O Requests with a Response Time greater than 30 milliseconds.*

SPC-1 Workload Generator Input Parameters

The SPC-1 Workload Generator input parameters for the Sustainability, IOPS, Response Time Ramp, Repeatability, and Persistence Test Runs are documented in “Appendix D: SPC-1 Workload Generator Input Parameters” on Page 68.

IOPS Test Results File

A link to the test results file generated from the IOPS Test Run is listed below.

[IOPS Test Results File](#)

IOPS Test Run – I/O Request Throughput Distribution Data

2022 BSUs	Start	Stop	Interval	Duration
<i>Start-Up/Ramp-Up</i>	22:17:27	22:20:28	0-2	0:03:01
<i>Measurement Interval</i>	22:20:28	22:30:28	3-12	0:10:00
60 second intervals	All ASUs	ASU1	ASU2	ASU3
0	101,186.72	60,310.70	12,467.52	28,408.50
1	101,078.00	60,242.00	12,421.92	28,414.08
2	101,098.45	60,282.97	12,438.35	28,377.13
3	101,111.67	60,258.78	12,421.42	28,431.47
4	101,089.40	60,289.95	12,469.23	28,330.22
5	101,115.72	60,273.75	12,441.03	28,400.93
6	101,031.10	60,251.45	12,423.17	28,356.48
7	101,123.78	60,263.82	12,430.57	28,429.40
8	101,136.55	60,302.95	12,416.80	28,416.80
9	100,887.33	60,170.25	12,410.23	28,306.85
10	101,292.27	60,366.12	12,461.70	28,464.45
11	101,142.05	60,287.80	12,447.38	28,406.87
12	101,086.92	60,220.60	12,436.07	28,430.25
Average	101,101.68	60,268.55	12,435.76	28,397.37

IOPS Test Run – I/O Request Throughput Distribution Graph

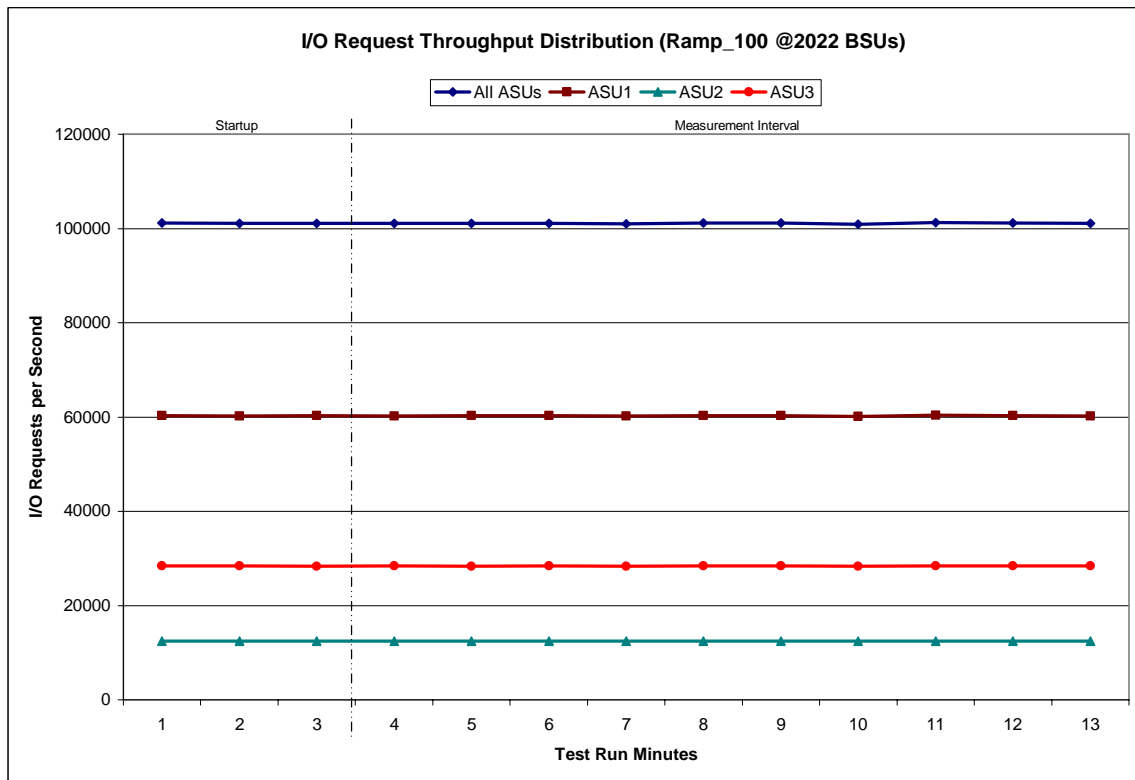

IOPS Test Run – Response Time Frequency Distribution Data

Response Time (ms)	0-0.25	>0.25-0.5	>0.5-0.75	>0.75-1.0	>1.0-1.25	>1.25-1.5	>1.5-1.75	>1.75-2.0
Read	211864	2,002,894	1,099,547	883,463	752,604	653,837	573,320	511,018
Write	0	1,492,783	2,633,631	2,154,203	1,877,587	1,645,615	1,433,921	1,261,143
All ASUs	211864	3,495,677	3,733,178	3,037,666	2,630,191	2,299,452	2,007,241	1,772,161
ASU1	191293	2,585,379	2,178,239	1,718,496	1,462,756	1,273,146	1,113,832	985,065
ASU2	20571	441,197	437,586	341,925	288,267	252,106	220,428	195,501
ASU3	0	469,101	1,117,353	977,245	879,168	774,200	672,981	591,595
Response Time (ms)	>2.0-2.5	>2.5-3.0	>3.0-3.5	>3.5-4.0	>4.0-4.5	>4.5-5.0	>5.0-6.0	>6.0-7.0
Read	901,579	822,487	789,701	773,679	763,430	755,312	1,459,617	1,296,254
Write	2,132,207	1,822,691	1,672,477	1,584,990	1,507,997	1,424,255	2,581,411	2,135,187
All ASUs	3,033,786	2,645,178	2,462,178	2,358,669	2,271,427	2,179,567	4,041,028	3,431,441
ASU1	1,698,578	1,499,880	1,412,043	1,360,385	1,316,415	1,267,093	2,366,761	2,015,248
ASU2	337,508	298,441	281,243	274,776	267,694	262,182	495,471	428,052
ASU3	997,700	846,857	768,892	723,508	687,318	650,292	1,178,796	988,141
Response Time (ms)	>7.0-8.0	>8.0-9.0	>9.0-10.0	>10.0-15.0	>15.0-20.0	>20.0-25.0	>25.0-30.0	>30.0
Read	1,061,375	843,422	690,976	2,389,504	1,385,060	827,989	536,986	1,930,527
Write	1,602,019	1,154,162	855,300	2,078,943	814,593	471,461	336,390	2,071,113
All ASUs	2,663,394	1,997,584	1,546,276	4,468,447	2,199,653	1,299,450	873,376	4,001,640
ASU1	1,575,272	1,191,638	932,351	2,808,951	1,447,787	854,946	567,372	2,337,878
ASU2	337,643	258,124	204,018	631,120	331,895	199,050	131,569	525,016
ASU3	750,479	547,822	409,907	1,028,376	419,971	245,454	174,435	1,138,746

IOPS Test Run –Response Time Frequency Distribution Graph

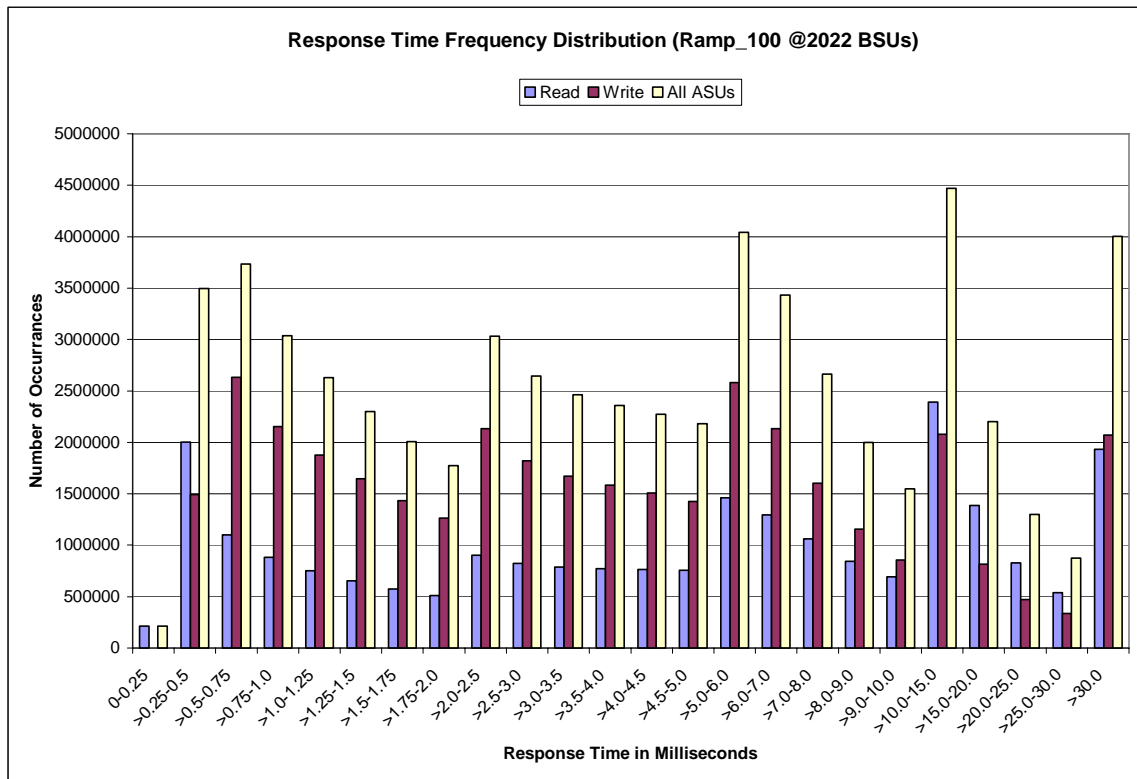

IOPS Test Run – Average Response Time (ms) Distribution Data

2022 BSUs	Start	Stop	Interval	Duration
Start-Up/Ramp-Up	22:17:27	22:20:28	0-2	0:03:01
Measurement Interval	22:20:28	22:30:28	3-12	0:10:00
60 second intervals	All ASUs	ASU1	ASU2	ASU3
0	17.30	16.77	19.58	17.42
1	8.96	8.80	9.44	9.10
2	9.12	8.94	9.60	9.30
3	8.96	8.86	9.47	8.95
4	10.09	9.89	10.47	10.32
5	10.76	10.49	11.15	11.17
6	11.30	11.13	11.65	11.49
7	20.89	20.27	19.32	22.87
8	12.03	11.68	12.27	12.67
9	14.52	14.17	14.40	15.32
10	10.87	10.53	11.37	11.37
11	8.78	8.73	9.33	8.64
12	8.25	8.23	8.79	8.05
Average	11.64	11.40	11.82	12.08

IOPS Test Run – Average Response Time (ms) Distribution Graph

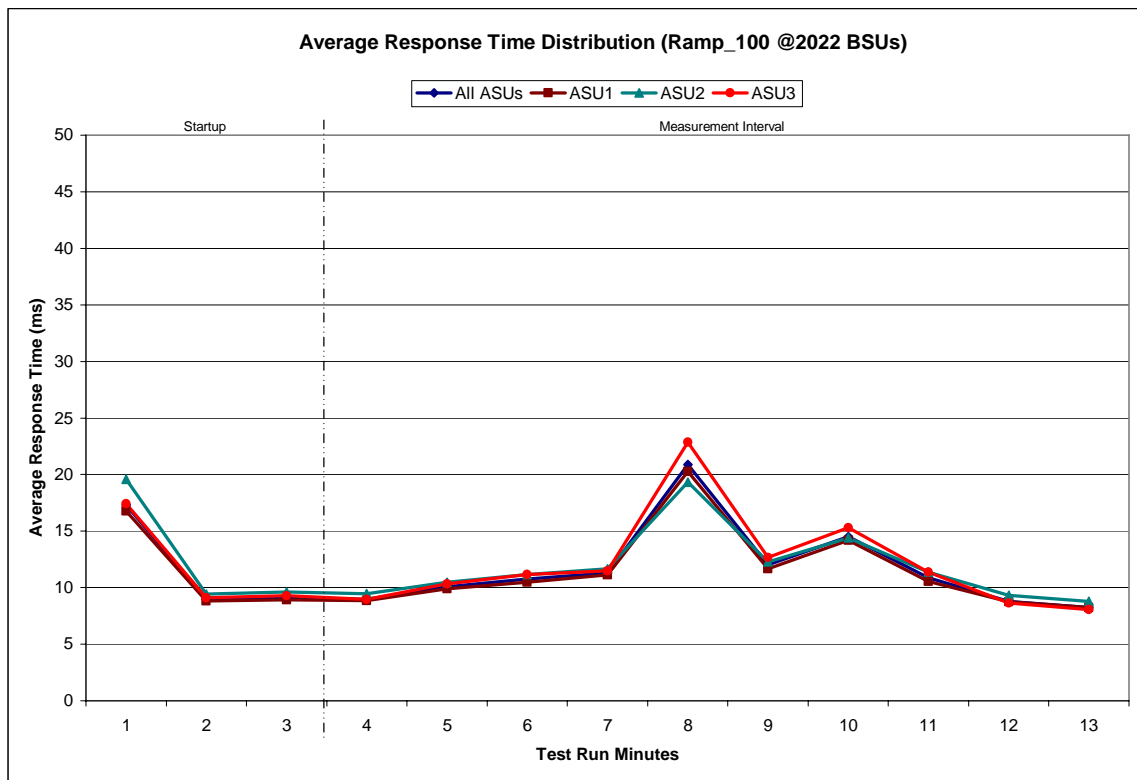

IOPS Test Run – I/O Request Information

I/O Requests Completed in the Measurement Interval	I/O Requests Completed with Response Time = or < 30 ms	I/O Requests Completed with Response Time > 30 ms
60,660,524	56,658,884	4,001,640

IOPS Test Run – Measured Intensity Multiplier and Coefficient of Variation

	ASU1-1	ASU1-2	ASU1-3	ASU1-4	ASU2-1	ASU2-2	ASU2-3	ASU3-1
IM	0.0350	0.2810	0.0700	0.2100	0.0180	0.0700	0.0350	0.2810
MIM	0.0350	0.2809	0.0700	0.2101	0.0180	0.0700	0.0350	0.2809
COV	0.002	0.000	0.001	0.001	0.003	0.001	0.002	0.001

Clause 3.4.3

IM – Intensity Multiplier: The ratio of I/Os for each I/O stream relative to the total I/Os for all I/O streams (ASU1-1 – ASU3-1) as required by the benchmark specification.

Clauses 5.1.0 and 5.3.13.2

MIM – Measured Intensity Multiplier: The Measured Intensity Multiplier represents the ratio of measured I/Os for each I/O stream relative to the total I/Os measured for all I/O streams (ASU1-1 – ASU3-1). This value may differ from the corresponding Expected Intensity Multiplier by no more than 5%.

Clause 5.3.13.3

COV – Coefficient of Variation: This measure of variation for the Measured Intensity Multiplier cannot exceed 0.2.

Primary Metrics Test – Response Time Ramp Test Phase

Clause 5.4.2.3

The Response Time Ramp Test Phase consists of five Test Runs, one each at 95%, 90%, 80%, 50%, and 10% of the load point (100%) used to generate the SPC-1 IOPS™ primary metric. Each of the five Test Runs has a Measurement Interval of ten (10) minutes. The Response Time Ramp Test Phase immediately follows the IOPS Test Phase without any interruption or manual intervention.

The five Response Time Ramp Test Runs, in conjunction with the IOPS Test Run (100%), demonstrate the relationship between Average Response Time and I/O Request Throughput for the Tested Storage Configuration (TSC) as illustrated in the response time/throughput curve on page 11.

In addition, the Average Response Time measured during the 10% Test Run is the value for the SPC-1 LRT™ metric. That value represents the Average Response Time of a lightly loaded TSC.

Clause 9.2.4.7.3

The following content shall appear in the FDR for the Response Time Ramp Phase:

1. A Response Time Ramp Distribution.
2. The human readable Test Run Results File produced by the Workload Generator for each Test Run within the Response Time Ramp Test Phase.
3. For the 10% Load Level Test Run (SPC-1 LRT™ metric) an Average Response Time Distribution.
4. A listing or screen image of all input parameters supplied to the Workload Generator.

SPC-1 Workload Generator Input Parameters

The SPC-1 Workload Generator input parameters for the Sustainability, IOPS, Response Time Ramp, Repeatability, and Persistence Test Runs are documented in “Appendix D: SPC-1 Workload Generator Input Parameters” on Page 68.

Response Time Ramp Test Results File

A link to each test result file generated from each Response Time Ramp Test Run list listed below.

[95% Load Level](#)

[90% Load Level](#)

[80% Load Level](#)

[50% Load Level](#)

[10% Load Level](#)

Response Time Ramp Distribution (IOPS) Data

The five Test Runs that comprise the Response Time Ramp Phase are executed at 95%, 90%, 80%, 50%, and 10% of the Business Scaling Unit (BSU) load level used to produce the SPC-1 IOPS™ primary metric. The 100% BSU load level is included in the following Response Time Ramp data tables and graphs for completeness.

100% Load Level - 2022 BSUs					95% Load Level - 1920 BSUs				
	Start	Stop	Interval	Duration		Start	Stop	Interval	Duration
Start-Up/Ramp-Up	22:17:27	22:20:28	0-2	0:03:01	Start-Up/Ramp-Up	22:30:52	22:33:53	0-2	0:03:01
Measurement Interval	22:20:28	22:30:28	3-12	0:10:00	Measurement Interval	22:33:53	22:43:53	3-12	0:10:00
(60 second intervals)	All ASUs	ASU-1	ASU-2	ASU-3	(60 second intervals)	All ASUs	ASU-1	ASU-2	ASU-3
0	101,186.72	60,310.70	12,467.52	28,408.50	0	96,109.13	57,262.55	11,849.63	26,996.95
1	101,078.00	60,242.00	12,421.92	28,414.08	1	95,992.80	57,205.52	11,816.07	26,971.22
2	101,098.45	60,282.97	12,438.35	28,377.13	2	96,037.45	57,278.52	11,789.37	26,969.57
3	101,111.67	60,258.78	12,421.42	28,431.47	3	96,022.88	57,214.43	11,819.30	26,989.15
4	101,089.40	60,289.95	12,469.23	28,330.22	4	95,976.72	57,210.60	11,824.03	26,942.08
5	101,115.72	60,273.75	12,441.03	28,400.93	5	95,960.68	57,215.28	11,779.00	26,966.40
6	101,031.10	60,251.45	12,423.17	28,356.48	6	95,949.28	57,209.72	11,801.77	26,937.80
7	101,123.78	60,263.82	12,430.57	28,429.40	7	96,006.63	57,204.10	11,808.13	26,994.40
8	101,136.55	60,302.95	12,416.80	28,416.80	8	95,958.33	57,192.07	11,789.70	26,976.57
9	100,887.33	60,170.25	12,410.23	28,306.85	9	95,992.43	57,240.40	11,785.92	26,966.12
10	101,292.27	60,366.12	12,461.70	28,464.45	10	96,030.13	57,228.10	11,793.37	27,008.67
11	101,142.05	60,287.80	12,447.38	28,406.87	11	96,049.32	57,209.95	11,824.15	27,015.22
12	101,086.92	60,220.60	12,436.07	28,430.25	12	96,036.07	57,217.83	11,817.18	27,001.05
Average	101,101.68	60,268.55	12,435.76	28,397.37	Average	95,998.25	57,214.25	11,804.26	26,979.75
90% Load Level - 1819 BSUs					80% Load Level - 1617 BSUs				
	Start	Stop	Interval	Duration		Start	Stop	Interval	Duration
Start-Up/Ramp-Up	22:44:15	22:47:16	0-2	0:03:01	Start-Up/Ramp-Up	22:57:37	23:00:38	0-2	0:03:01
Measurement Interval	22:47:16	22:57:16	3-12	0:10:00	Measurement Interval	23:00:38	23:10:38	3-12	0:10:00
(60 second intervals)	All ASUs	ASU-1	ASU-2	ASU-3	(60 second intervals)	All ASUs	ASU-1	ASU-2	ASU-3
0	91,099.07	54,305.40	11,174.90	25,618.77	0	80,932.62	48,210.97	9,966.75	22,754.90
1	91,002.80	54,213.50	11,192.30	25,597.00	1	80,858.82	48,188.73	9,938.10	22,731.98
2	90,894.00	54,152.62	11,195.25	25,546.13	2	80,803.42	48,153.97	9,949.92	22,699.53
3	90,954.32	54,186.77	11,190.78	25,576.77	3	80,836.62	48,183.70	9,936.40	22,716.52
4	90,926.27	54,204.28	11,173.85	25,548.13	4	80,832.18	48,190.92	9,949.37	22,691.90
5	90,990.80	54,214.87	11,204.17	25,571.77	5	80,804.93	48,171.38	9,913.23	22,720.32
6	90,978.48	54,229.22	11,200.75	25,548.52	6	80,817.88	48,177.22	9,924.48	22,716.18
7	90,932.97	54,203.08	11,172.23	25,557.65	7	80,853.38	48,215.83	9,908.33	22,729.22
8	90,888.38	54,172.25	11,183.98	25,532.15	8	80,868.95	48,199.03	9,919.68	22,750.23
9	90,981.27	54,208.32	11,184.40	25,588.55	9	80,889.95	48,222.72	9,935.15	22,732.08
10	90,971.30	54,205.90	11,203.75	25,561.65	10	80,781.30	48,153.22	9,943.00	22,685.08
11	90,901.48	54,197.45	11,187.77	25,516.27	11	80,825.75	48,201.50	9,921.47	22,702.78
12	90,877.97	54,187.67	11,184.93	25,505.37	12	80,849.30	48,197.00	9,949.53	22,702.77
Average	90,940.32	54,200.98	11,188.66	25,550.68	Average	80,836.03	48,191.25	9,930.07	22,714.71
50% Load Level - 1011 BSUs					10% Load Level - 202 BSUs				
	Start	Stop	Interval	Duration		Start	Stop	Interval	Duration
Start-Up/Ramp-Up	23:10:54	23:13:55	0-2	0:03:01	Start-Up/Ramp-Up	23:24:06	23:27:07	0-2	0:03:01
Measurement Interval	23:13:55	23:23:55	3-12	0:10:00	Measurement Interval	23:27:07	23:37:07	3-12	0:10:00
(60 second intervals)	All ASUs	ASU-1	ASU-2	ASU-3	(60 second intervals)	All ASUs	ASU-1	ASU-2	ASU-3
0	50,601.33	30,143.00	6,222.58	14,235.75	0	10,118.73	6,021.93	1,249.80	2,847.00
1	50,536.40	30,128.22	6,210.42	14,197.77	1	10,103.43	6,025.22	1,248.22	2,830.00
2	50,518.12	30,074.92	6,219.72	14,223.48	2	10,097.53	6,033.37	1,240.83	2,823.33
3	50,565.87	30,137.83	6,221.72	14,206.32	3	10,117.18	6,026.17	1,243.98	2,847.03
4	50,532.58	30,132.90	6,206.17	14,193.52	4	10,108.50	6,026.82	1,247.62	2,834.07
5	50,556.77	30,133.87	6,210.15	14,212.75	5	10,093.23	6,004.83	1,240.48	2,847.92
6	50,542.37	30,128.53	6,217.02	14,196.82	6	10,087.47	6,010.40	1,240.73	2,836.33
7	50,577.97	30,153.30	6,213.75	14,210.92	7	10,083.23	6,012.95	1,237.43	2,832.85
8	50,530.02	30,113.13	6,207.07	14,209.82	8	10,133.48	6,024.60	1,243.58	2,865.30
9	50,576.62	30,160.23	6,221.50	14,194.88	9	10,120.22	6,028.35	1,249.40	2,842.47
10	50,561.25	30,137.28	6,213.52	14,210.45	10	10,102.67	6,012.57	1,240.93	2,849.17
11	50,513.48	30,126.63	6,210.17	14,176.68	11	10,085.38	6,013.38	1,242.78	2,829.22
12	50,565.42	30,140.92	6,226.82	14,197.68	12	10,110.18	6,025.98	1,236.20	2,848.00
Average	50,552.23	30,136.46	6,214.79	14,200.98	Average	10,104.16	6,018.61	1,242.32	2,843.24

Response Time Ramp Distribution (IOPS) Graph

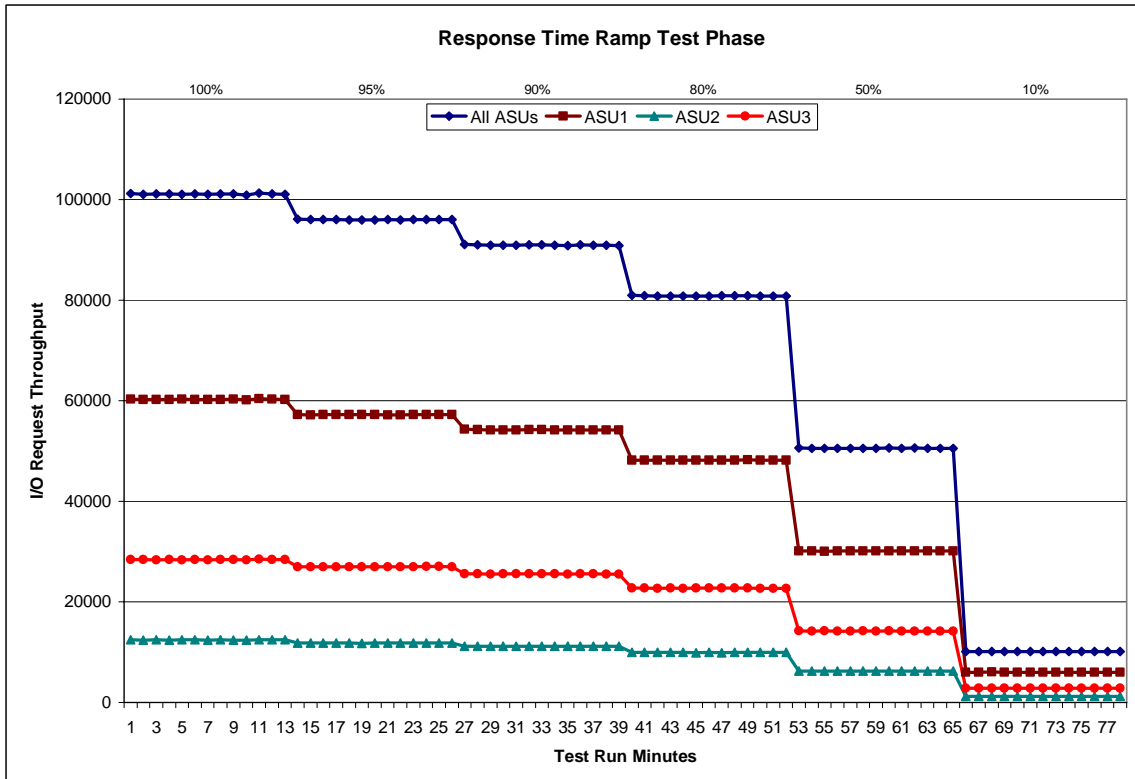

SPC-1 LRT™ Average Response Time (ms) Distribution Data

202 BSUs	Start	Stop	Interval	Duration
<i>Start-Up/Ramp-Up</i>	23:24:06	23:27:07	0-2	0:03:01
<i>Measurement Interval</i>	23:27:07	23:37:07	3-12	0:10:00
60 second intervals	All ASUs	ASU1	ASU2	ASU3
0	0.97	1.12	1.45	0.46
1	0.93	1.08	1.32	0.45
2	0.94	1.09	1.33	0.46
3	0.95	1.10	1.38	0.45
4	0.91	1.04	1.32	0.45
5	0.90	1.03	1.31	0.46
6	0.91	1.05	1.29	0.45
7	0.92	1.06	1.32	0.46
8	0.94	1.08	1.38	0.46
9	0.95	1.09	1.39	0.46
10	1.00	1.18	1.42	0.46
11	0.91	1.04	1.33	0.46
12	0.91	1.04	1.32	0.45
Average	0.93	1.07	1.34	0.46

SPC-1 LRT™ Average Response Time (ms) Distribution Graph

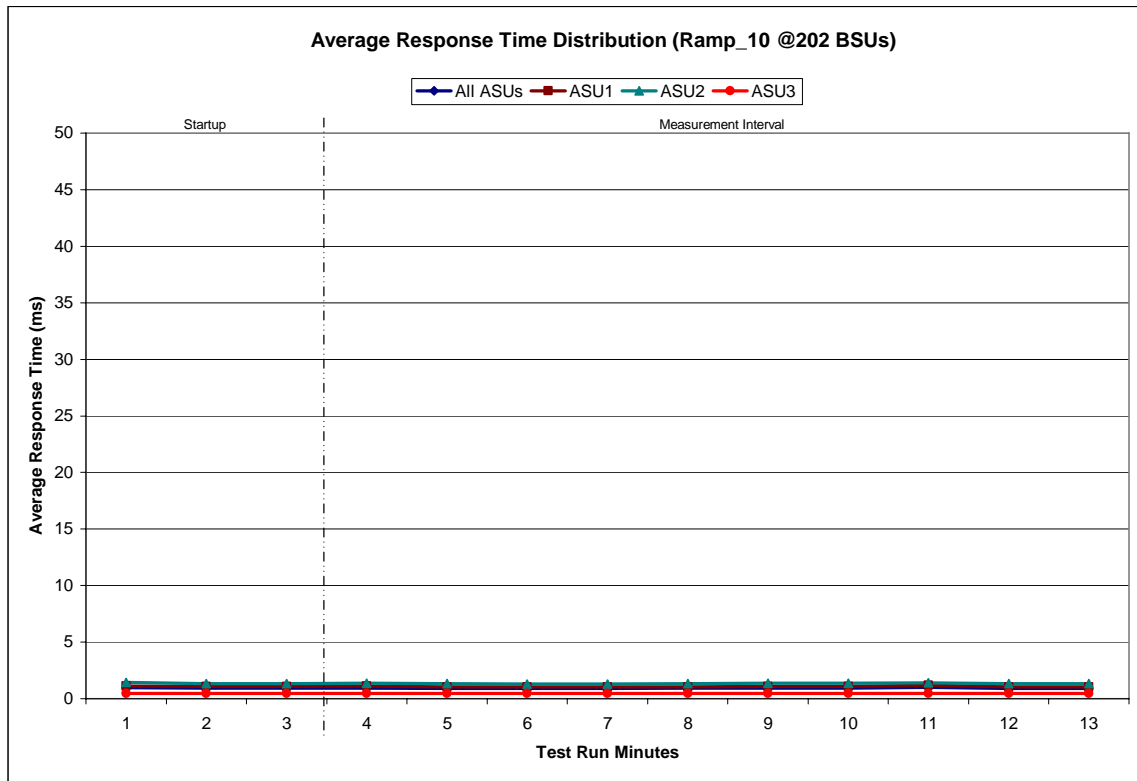

SPC-1 LRT™ (10%) – Measured Intensity Multiplier and Coefficient of Variation

	ASU1-1	ASU1-2	ASU1-3	ASU1-4	ASU2-1	ASU2-2	ASU2-3	ASU3-1
IM	0.0350	0.2810	0.0700	0.2100	0.0180	0.0700	0.0350	0.2810
MIM	0.0351	0.2808	0.0699	0.2099	0.0180	0.0700	0.0349	0.2814
COV	0.008	0.001	0.006	0.002	0.010	0.005	0.010	0.003

Clause 3.4.3

IM – Intensity Multiplier: The ratio of I/Os for each I/O stream relative to the total I/Os for all I/O streams (ASU1-1 – ASU3-1) as required by the benchmark specification.

Clauses 5.1.0 and 5.3.13.2

MIM – Measured Intensity Multiplier: The Measured Intensity Multiplier represents the ratio of measured I/Os for each I/O stream relative to the total I/Os measured for all I/O streams (ASU1-1 – ASU3-1). This value may differ from the corresponding Expected Intensity Multiplier by no more than 5%.

Clause 5.3.13.3

COV – Coefficient of Variation: This measure of variation for the Measured Intensity Multiplier cannot exceed 0.2.

Repeatability Test

Clause 5.4.5

The Repeatability Test demonstrates the repeatability and reproducibility of the SPC-1 IOPS™ primary metric and SPC-1 LRT™ metric generated in earlier Test Runs.

There are two identical Repeatability Test Phases. Each Test Phase contains two Test Runs. Each of the Test Runs will have a Measurement Interval of no less than ten (10) minutes. The two Test Runs in each Test Phase will be executed without interruption or any type of manual intervention.

The first Test Run in each Test Phase is executed at the 10% load point. The Average Response Time from each of the Test Runs is compared to the SPC-1 LRT™ metric. Each Average Response Time value must be less than the SPC-1 LRT™ metric plus 5%.

The second Test Run in each Test Phase is executed at the 100% load point. The I/O Request Throughput from the Test Runs is compared to the SPC-1 IOPS™ primary metric. Each I/O Request Throughput value must be greater than the SPC-1 IOPS™ primary metric minus 5%. In addition, the Average Response Time for each Test Run cannot exceed 30 milliseconds.

If any of the above constraints are not met, the benchmark measurement is invalid.

Clause 9.2.4.7.4

The following content shall appear in the FDR for each Test Run in the two Repeatability Test Phases:

- 1. A table containing the results of the Repeatability Test.*
- 2. An I/O Request Throughput Distribution graph and table.*
- 3. An Average Response Time Distribution graph and table.*
- 4. The human readable Test Run Results File produced by the Workload Generator.*
- 5. A listing or screen image of all input parameters supplied to the Workload Generator.*

SPC-1 Workload Generator Input Parameters

The SPC-1 Workload Generator input parameters for the Sustainability, IOPS, Response Time Ramp, Repeatability, and Persistence Test Runs are documented in “Appendix D: SPC-1 Workload Generator Input Parameters” on Page 68.

Repeatability Test Results File

The values for the SPC-1 IOPS™, SPC-1 LRT™, and the Repeatability Test measurements are listed below.

	SPC-1 IOPS™	SPC-1 LRT™
<i>Primary Metrics</i>	101,101.68	0.93
Repeatability Test Phase 1	101,122.40	0.91
Repeatability Test Phase 2	101,102.75	0.94

A link to the test result file generated from each Repeatability Test Run list is listed below.

[Repeatability Test Phase 1, Test Run 1 \(LRT\)](#)

[Repeatability Test Phase 1, Test Run 2 \(IOPS\)](#)

[Repeatability Test Phase 2, Test Run 1 \(LRT\)](#)

[Repeatability Test Phase 2, Test Run 2 \(IOPS\)](#)

Repeatability 1 LRT - I/O Request Throughput Distribution Data

202 BSUs	Start	Stop	Interval	Duration
<i>Start-Up/Ramp-Up</i>	23:38:12	23:41:12	0-2	0:03:00
<i>Measurement Interval</i>	23:41:12	23:51:12	3-12	0:10:00
60 second intervals	All ASUs	ASU1	ASU2	ASU3
0	10,105.33	6,034.37	1,237.37	2,833.60
1	10,085.52	6,007.57	1,233.82	2,844.13
2	10,111.22	6,029.38	1,243.45	2,838.38
3	10,110.48	6,024.25	1,246.02	2,840.22
4	10,108.85	6,018.35	1,252.65	2,837.85
5	10,098.00	6,014.52	1,237.33	2,846.15
6	10,088.10	6,018.00	1,237.95	2,832.15
7	10,099.25	6,019.90	1,239.70	2,839.65
8	10,097.02	6,013.32	1,243.47	2,840.23
9	10,086.33	6,004.60	1,241.87	2,839.87
10	10,105.05	6,019.88	1,244.57	2,840.60
11	10,097.55	6,013.02	1,238.77	2,845.77
12	10,081.92	6,017.17	1,235.18	2,829.57
Average	10,097.26	6,016.30	1,241.75	2,839.21

Repeatability 1 LRT - I/O Request Throughput Distribution Graph

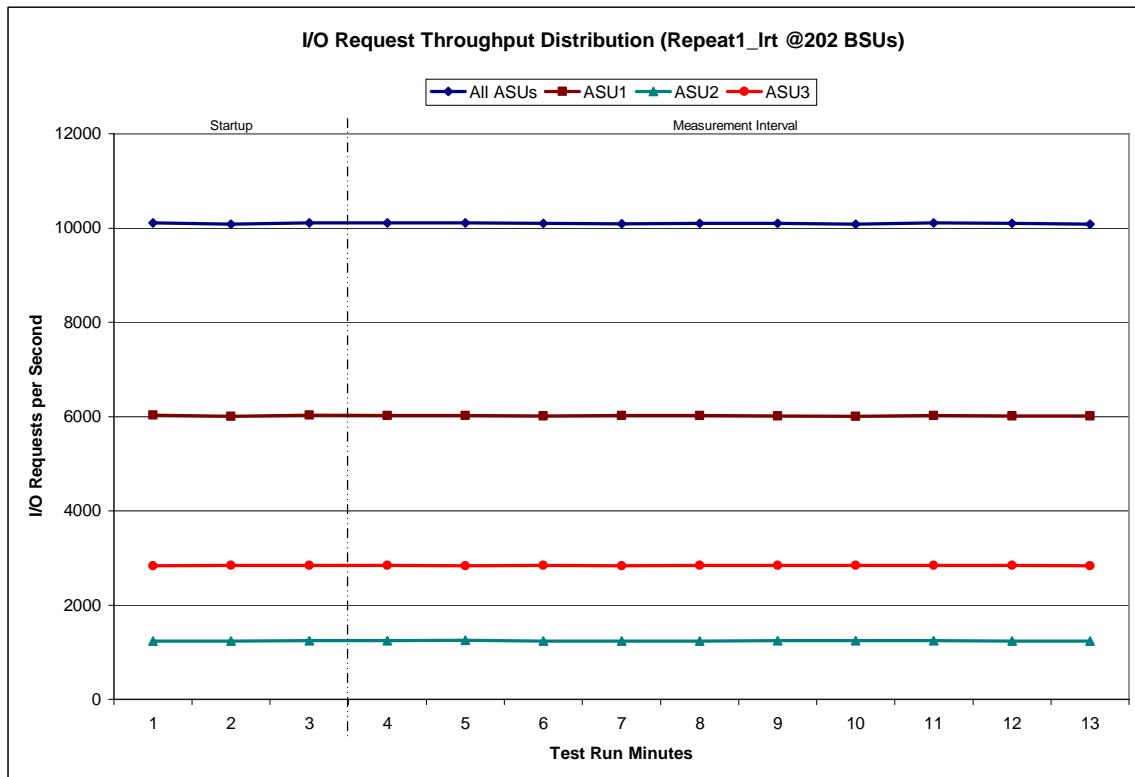

Repeatability 1 LRT –Average Response Time (ms) Distribution Data

202 BSUs	Start	Stop	Interval	Duration
<i>Start-Up/Ramp-Up</i>	23:38:12	23:41:12	0-2	0:03:00
<i>Measurement Interval</i>	23:41:12	23:51:12	3-12	0:10:00
60 second intervals	All ASUs	ASU1	ASU2	ASU3
0	0.97	1.11	1.46	0.46
1	0.91	1.04	1.31	0.46
2	0.91	1.03	1.30	0.46
3	0.93	1.07	1.34	0.46
4	0.93	1.07	1.34	0.45
5	0.91	1.04	1.31	0.46
6	0.90	1.02	1.30	0.46
7	0.90	1.02	1.30	0.46
8	0.92	1.05	1.31	0.46
9	0.92	1.05	1.36	0.45
10	0.89	1.02	1.29	0.45
11	0.89	1.02	1.30	0.46
12	0.89	1.01	1.29	0.45
Average	0.91	1.04	1.31	0.46

Repeatability 1 LRT –Average Response Time (ms) Distribution Graph

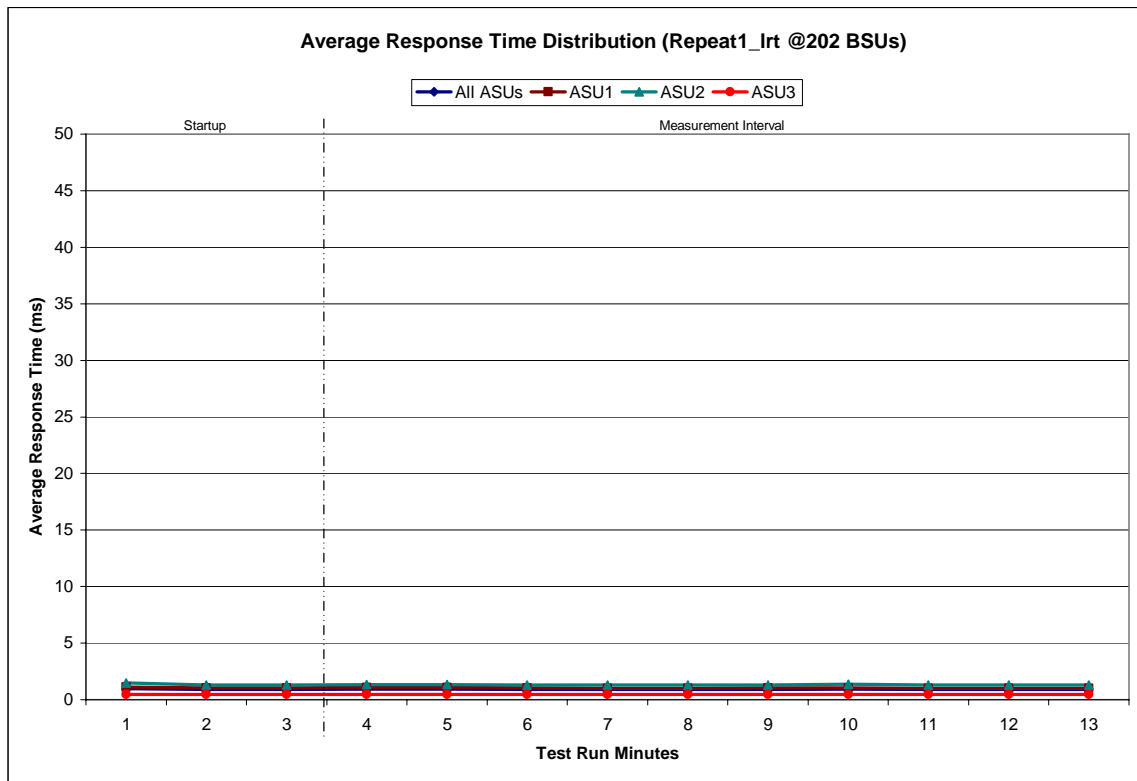

Repeatability 1 IOPS - I/O Request Throughput Distribution Data

2022 BSUs	Start	Stop	Interval	Duration
Start-Up/Ramp-Up	23:51:39	23:54:40	0-2	0:03:01
Measurement Interval	23:54:40	0:04:40	3-12	0:10:00
60 second intervals	All ASUs	ASU1	ASU2	ASU3
0	101,124.30	60,274.27	12,449.35	28,400.68
1	101,099.98	60,273.17	12,403.63	28,423.18
2	101,038.78	60,235.48	12,408.13	28,395.17
3	101,086.03	60,257.17	12,421.80	28,407.07
4	100,571.85	59,944.13	12,359.80	28,267.92
5	100,175.90	59,699.97	12,315.05	28,160.88
6	100,633.67	60,015.45	12,366.90	28,251.32
7	97,508.82	58,132.45	11,987.72	27,388.65
8	100,568.93	59,967.93	12,360.10	28,240.90
9	103,565.70	61,729.20	12,737.35	29,099.15
10	102,668.23	61,207.62	12,630.47	28,830.15
11	103,326.08	61,580.75	12,715.60	29,029.73
12	101,118.77	60,262.22	12,452.88	28,403.67
Average	101,122.40	60,279.69	12,434.77	28,407.94

Repeatability 1 IOPS - I/O Request Throughput Distribution Graph

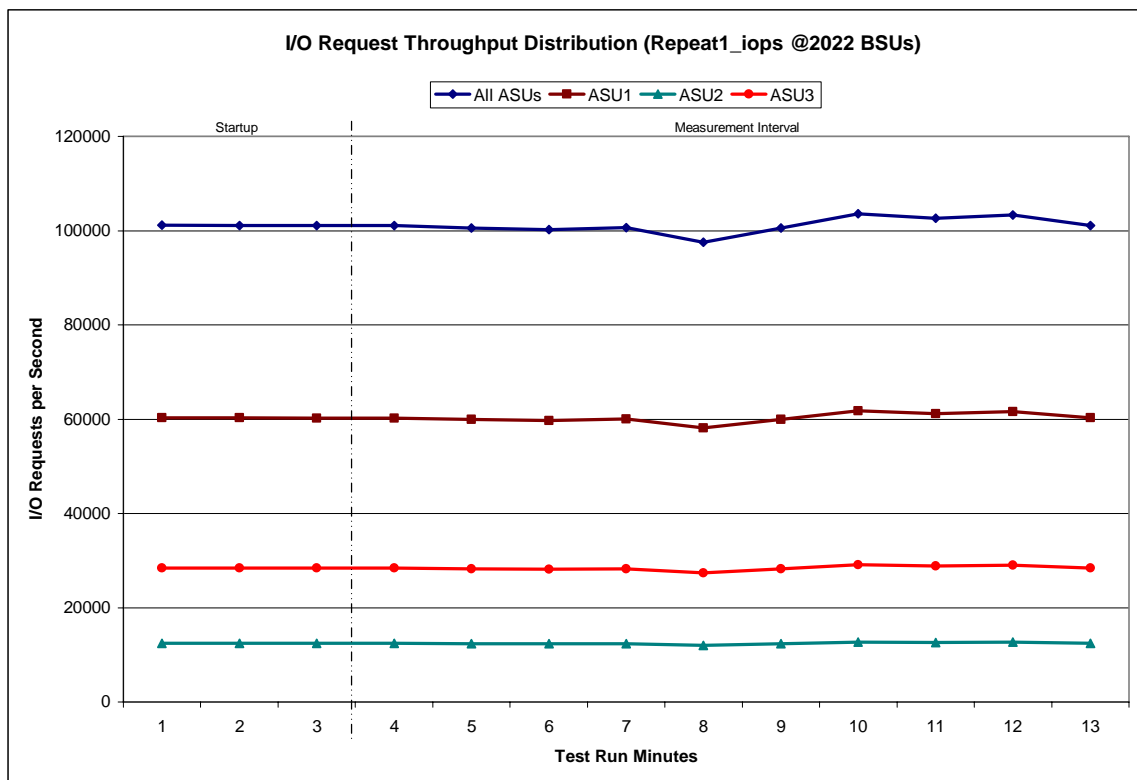

Repeatability 1 IOPS –Average Response Time (ms) Distribution Data

2022 BSUs	Start	Stop	Interval	Duration
<i>Start-Up/Ramp-Up</i>	23:51:39	23:54:40	0-2	0:03:01
<i>Measurement Interval</i>	23:54:40	0:04:40	3-12	0:10:00
60 second intervals	All ASUs	ASU1	ASU2	ASU3
0	8.68	8.60	9.49	8.52
1	7.03	7.06	7.78	6.64
2	8.60	8.51	9.21	8.54
3	9.24	9.06	9.76	9.40
4	25.57	26.32	25.80	23.87
5	35.63	35.75	35.71	35.33
6	31.82	31.48	32.75	32.13
7	36.22	35.65	38.44	36.46
8	35.03	34.16	36.53	36.23
9	32.39	33.31	27.15	32.73
10	29.51	29.76	25.51	30.71
11	23.09	23.07	20.89	24.09
12	10.81	10.58	11.29	11.10
Average	26.93	26.91	26.38	27.21

Repeatability 1 IOPS –Average Response Time (ms) Distribution Graph

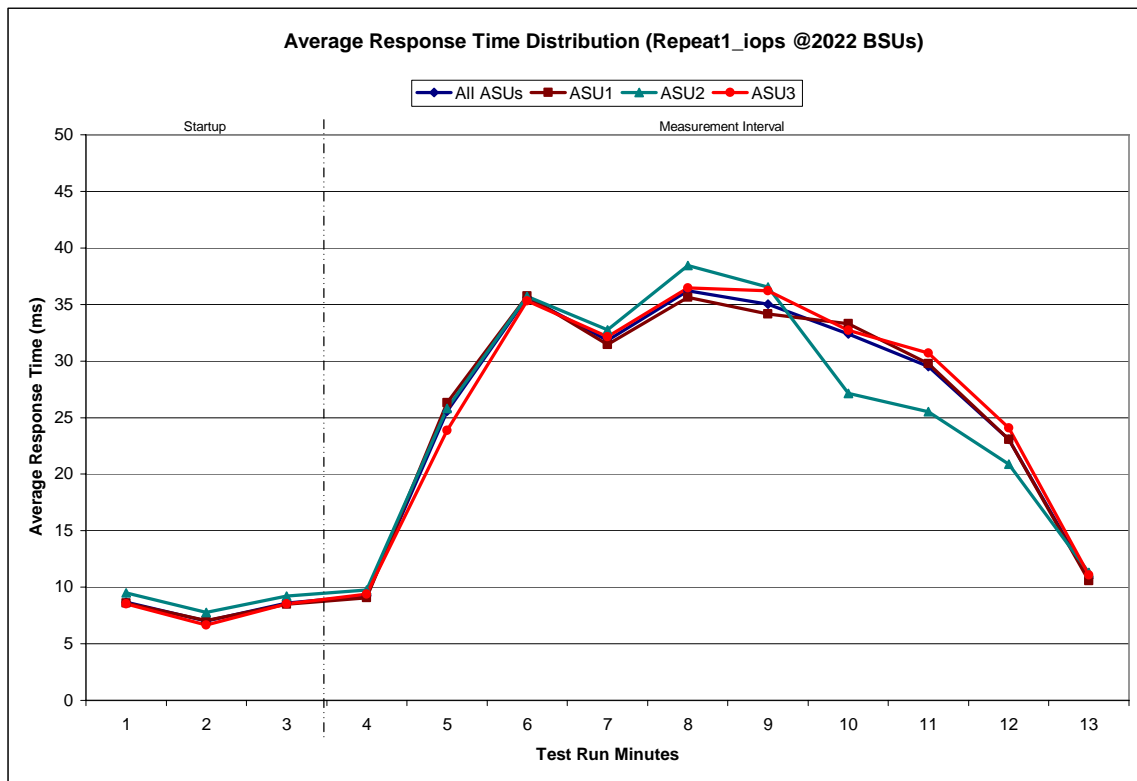

Repeatability 2 LRT - I/O Request Throughput Distribution Data

202 BSUs	Start	Stop	Interval	Duration
<i>Start-Up/Ramp-Up</i>	0:05:33	0:08:33	0-2	0:03:00
<i>Measurement Interval</i>	0:08:33	0:18:33	3-12	0:10:00
60 second intervals	All ASUs	ASU1	ASU2	ASU3
0	10,125.62	6,031.93	1,246.63	2,847.05
1	10,079.62	5,999.80	1,250.42	2,829.40
2	10,121.98	6,029.82	1,246.05	2,846.12
3	10,094.82	6,011.52	1,239.88	2,843.42
4	10,096.10	6,014.33	1,244.25	2,837.52
5	10,100.73	6,003.97	1,255.60	2,841.17
6	10,092.05	6,003.70	1,251.48	2,836.87
7	10,103.63	6,016.25	1,241.00	2,846.38
8	10,092.85	6,018.05	1,246.70	2,828.10
9	10,095.60	6,015.30	1,246.97	2,833.33
10	10,086.03	6,004.60	1,239.77	2,841.67
11	10,099.53	6,015.25	1,241.83	2,842.45
12	10,085.55	6,005.18	1,247.27	2,833.10
Average	10,094.69	6,010.82	1,245.48	2,838.40

Repeatability 2 LRT - I/O Request Throughput Distribution Graph

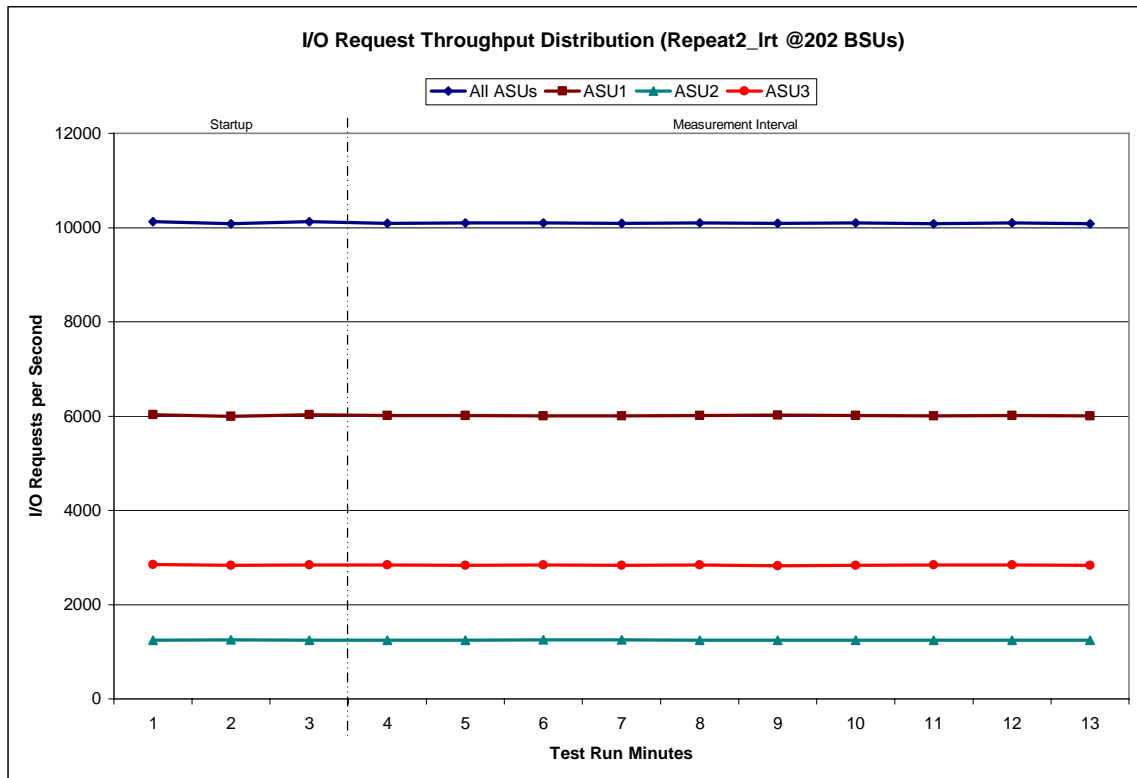

Repeatability 2 LRT –Average Response Time (ms) Distribution Data

202 BSUs	Start	Stop	Interval	Duration
<i>Start-Up/Ramp-Up</i>	0:05:33	0:08:33	0-2	0:03:00
<i>Measurement Interval</i>	0:08:33	0:18:33	3-12	0:10:00
60 second intervals	All ASUs	ASU1	ASU2	ASU3
0	1.01	1.18	1.44	0.46
1	0.99	1.16	1.38	0.46
2	0.97	1.14	1.37	0.46
3	0.94	1.08	1.33	0.46
4	0.93	1.08	1.31	0.46
5	0.94	1.09	1.31	0.45
6	0.97	1.13	1.37	0.46
7	0.95	1.09	1.35	0.46
8	0.92	1.06	1.29	0.46
9	0.91	1.04	1.29	0.46
10	0.93	1.07	1.31	0.45
11	0.96	1.11	1.38	0.46
12	0.94	1.08	1.33	0.46
Average	0.94	1.08	1.33	0.46

Repeatability 2 LRT –Average Response Time (ms) Distribution Graph

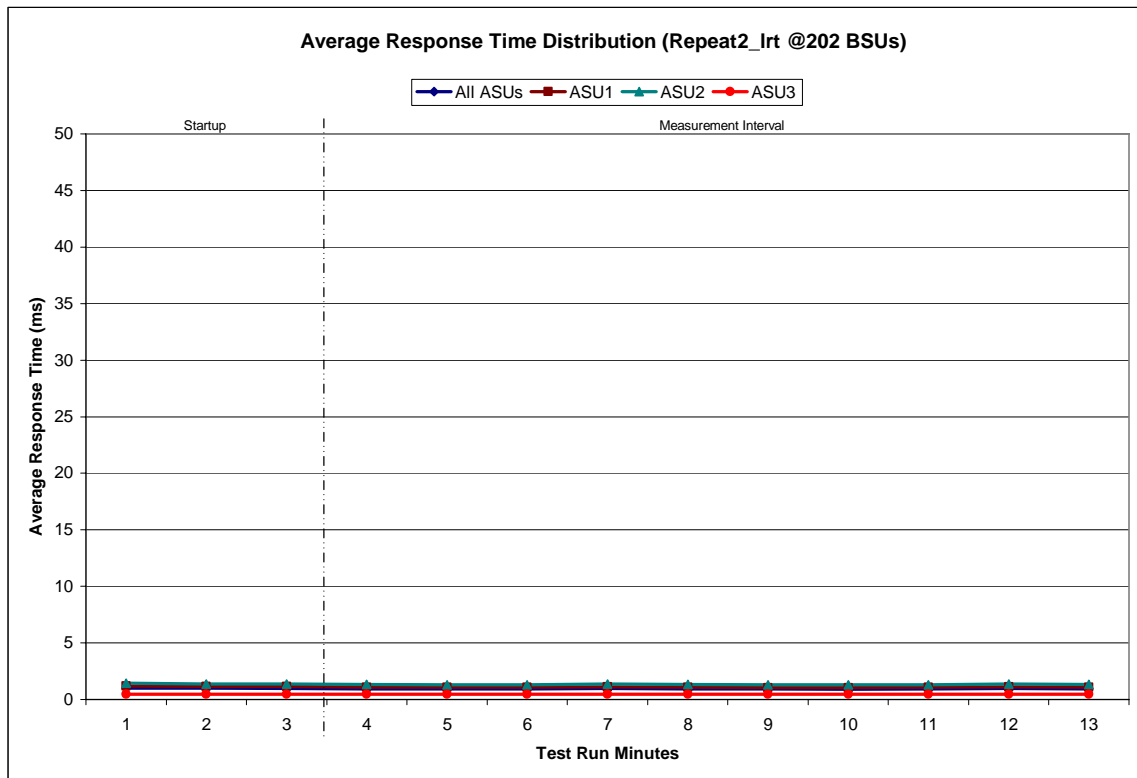

Repeatability 2 IOPS - I/O Request Throughput Distribution Data

2022 BSUs	Start	Stop	Interval	Duration
<i>Start-Up/Ramp-Up</i>	0:19:01	0:22:02	0-2	0:03:01
<i>Measurement Interval</i>	0:22:02	0:32:02	3-12	0:10:00
60 second intervals	All ASUs	ASU1	ASU2	ASU3
0	101,193.28	60,315.12	12,460.70	28,417.47
1	101,089.83	60,283.17	12,435.62	28,371.05
2	101,076.28	60,236.97	12,450.62	28,388.70
3	101,116.10	60,257.42	12,439.93	28,418.75
4	101,081.87	60,255.17	12,434.90	28,391.80
5	101,094.68	60,260.70	12,438.55	28,395.43
6	101,131.92	60,271.07	12,451.97	28,408.88
7	101,042.47	60,248.00	12,411.67	28,382.80
8	101,154.78	60,259.03	12,449.65	28,446.10
9	101,072.38	60,247.47	12,418.65	28,406.27
10	101,093.52	60,247.57	12,417.23	28,428.72
11	101,121.32	60,221.27	12,431.88	28,468.17
12	101,118.50	60,267.18	12,441.90	28,409.42
Average	101,102.75	60,253.49	12,433.63	28,415.63

Repeatability 2 IOPS - I/O Request Throughput Distribution Graph

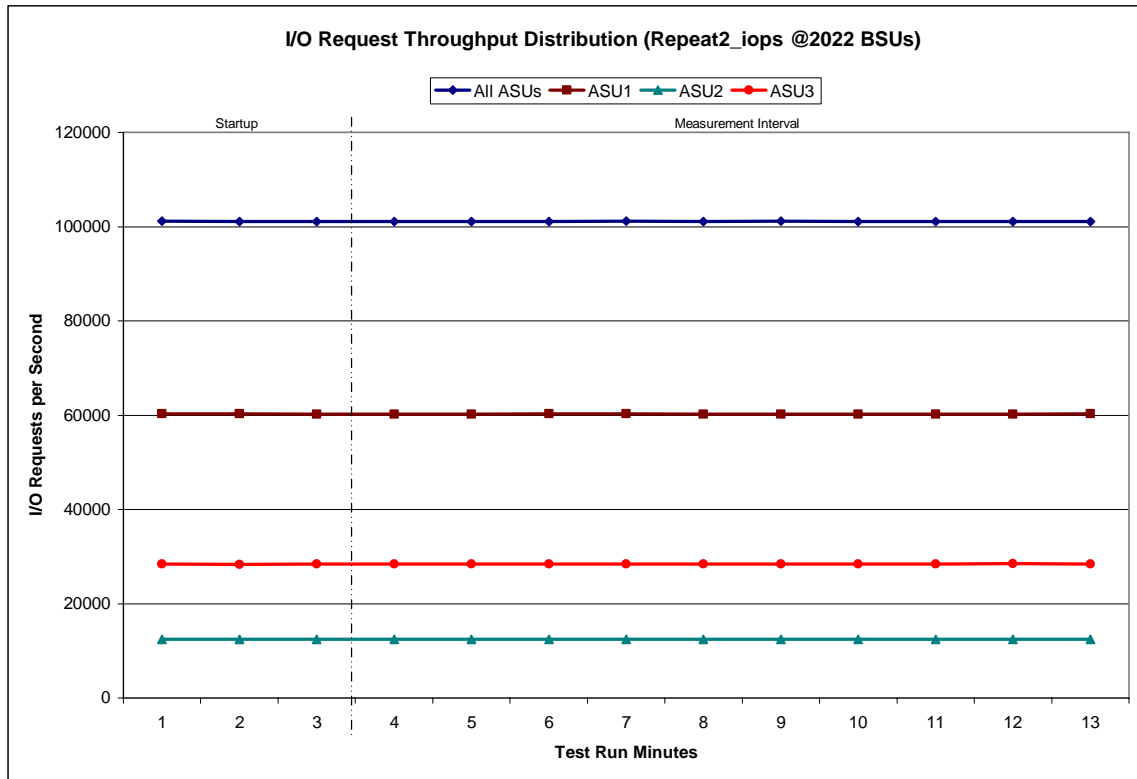

Repeatability 2 IOPS –Average Response Time (ms) Distribution Data

2022 BSUs	Start	Stop	Interval	Duration
<i>Start-Up/Ramp-Up</i>	0:19:01	0:22:02	0-2	0:03:01
<i>Measurement Interval</i>	0:22:02	0:32:02	3-12	0:10:00
60 second intervals	All ASUs	ASU1	ASU2	ASU3
0	7.08	7.13	7.91	6.61
1	7.38	7.38	7.91	7.15
2	8.70	8.64	9.16	8.60
3	10.14	9.98	10.53	10.29
4	10.49	10.31	10.85	10.70
5	9.26	9.20	9.66	9.24
6	8.83	8.79	9.27	8.73
7	9.29	9.26	9.75	9.17
8	8.14	8.19	8.75	7.79
9	8.05	8.04	8.70	7.79
10	8.83	8.82	9.32	8.65
11	9.77	9.66	10.15	9.84
12	9.11	9.03	9.60	9.05
Average	9.19	9.13	9.66	9.13

Repeatability 2 IOPS –Average Response Time (ms) Distribution Graph

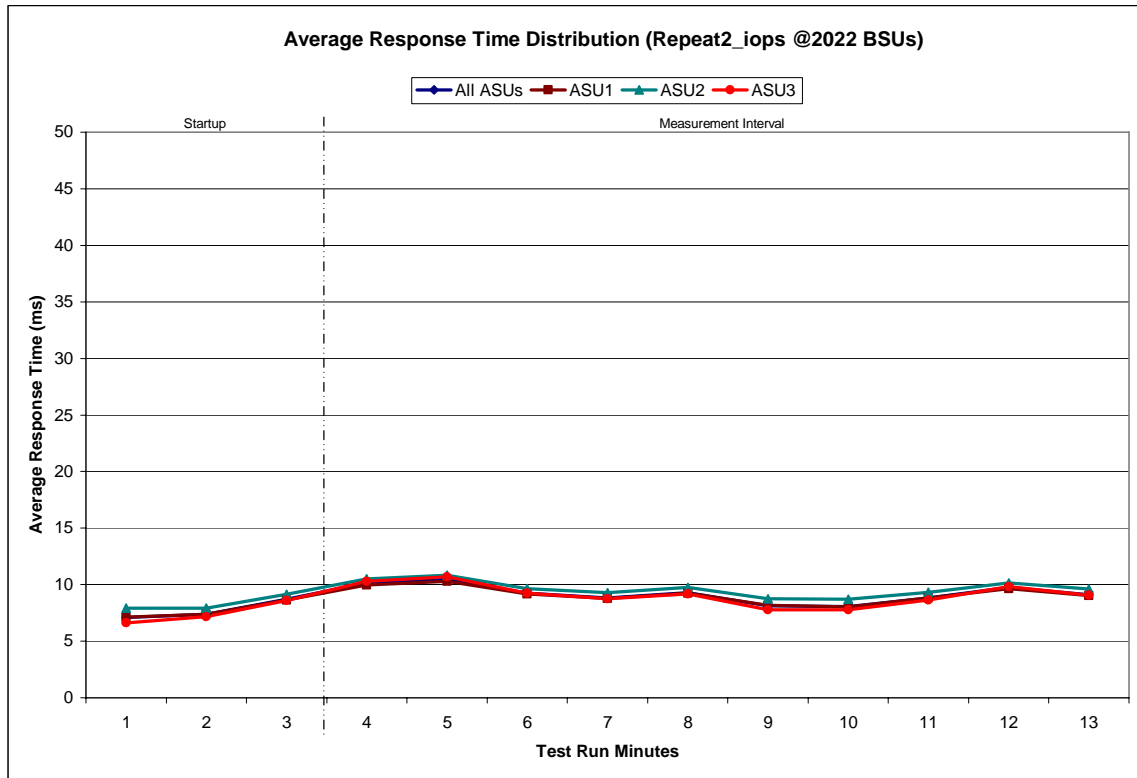

Repeatability 1 (LRT)
Measured Intensity Multiplier and Coefficient of Variation

	ASU1-1	ASU1-2	ASU1-3	ASU1-4	ASU2-1	ASU2-2	ASU2-3	ASU3-1
IM	0.0350	0.2810	0.0700	0.2100	0.0180	0.0700	0.0350	0.2810
MIM	0.0350	0.2808	0.0699	0.2101	0.0180	0.0700	0.0350	0.2812
COV	0.006	0.002	0.003	0.002	0.008	0.005	0.008	0.002

Clause 3.4.3

IM - Intensity Multiplier: The ratio of I/Os for each I/O stream relative to the total I/Os for all I/O streams (ASU1-1 – ASU3-1) as required by the benchmark specification.

Clauses 5.1.0 and 5.3.13.2

MIM - Measured Intensity Multiplier: The Measured Intensity Multiplier represents the ratio of measured I/Os for each I/O stream relative to the total I/Os measured for all I/O streams (ASU1-1 – ASU3-1). This value may differ from the corresponding Expected Intensity Multiplier by no more than 5%.

Clause 5.3.13.3

COV - Coefficient of Variation: This measure of variation for the Measured Intensity Multiplier cannot exceed 0.2.

Repeatability 1 (IOPS)
Measured Intensity Multiplier and Coefficient of Variation

	ASU1-1	ASU1-2	ASU1-3	ASU1-4	ASU2-1	ASU2-2	ASU2-3	ASU3-1
IM	0.0350	0.2810	0.0700	0.2100	0.0180	0.0700	0.0350	0.2810
MIM	0.0350	0.2811	0.0700	0.2100	0.0180	0.0700	0.0349	0.2809
COV	0.002	0.001	0.001	0.001	0.003	0.001	0.001	0.000

Repeatability 2 (LRT)
Measured Intensity Multiplier and Coefficient of Variation

	ASU1-1	ASU1-2	ASU1-3	ASU1-4	ASU2-1	ASU2-2	ASU2-3	ASU3-1
IM	0.0350	0.2810	0.0700	0.2100	0.0180	0.0700	0.0350	0.2810
MIM	0.0350	0.2806	0.0701	0.2097	0.0181	0.0700	0.0352	0.2812
COV	0.009	0.002	0.004	0.002	0.012	0.006	0.004	0.002

Repeatability 2 (IOPS)
Measured Intensity Multiplier and Coefficient of Variation

	ASU1-1	ASU1-2	ASU1-3	ASU1-4	ASU2-1	ASU2-2	ASU2-3	ASU3-1
<i>IM</i>	0.0350	0.2810	0.0700	0.2100	0.0180	0.0700	0.0350	0.2810
MIM	0.0350	0.2810	0.0701	0.2100	0.0180	0.0700	0.0350	0.2811
COV	0.001	0.001	0.001	0.001	0.002	0.001	0.002	0.001

Data Persistence Test

Clause 6

The Data Persistence Test demonstrates the Tested Storage Configuration (TSC):

- *Is capable of maintain data integrity across a power cycle.*
- *Ensures the transfer of data between Logical Volumes and host systems occurs without corruption or loss.*

The SPC-1 Workload Generator will write 16 block I/O requests at random over the total Addressable Storage Capacity of the TSC for ten (10) minutes at a minimum of 25% of the load used to generate the SPC-1 IOP™ primary metric. The bit pattern selected to be written to each block as well as the address of the block will be retained in a log file.

The Benchmark Configuration will be shutdown and restarted using a power off/power on cycle at the end of the above sequence of write operations. In addition, any caches employing battery backup must be flushed/emptied.

The SPC-1 Workload Generator will then use the above log file to verify each block written contains the correct bit pattern.

Clause 9.2.4.8

The following content shall appear in this section of the FDR:

1. *A listing or screen image of all input parameters supplied to the Workload Generator.*
2. *For the successful Data Persistence Test Run, a table illustrating key results. The content, appearance, and format of this table are specified in Table 9-12. Information displayed in this table shall be obtained from the Test Run Results File referenced below in #3.*
3. *For the successful Data Persistence Test Run, the human readable Test Run Results File produced by the Workload Generator.*

SPC-1 Workload Generator Input Parameters

The SPC-1 Workload Generator input parameters for the Sustainability, IOPS, Response Time Ramp, Repeatability, and Persistence Test Runs are documented in “Appendix D: SPC-1 Workload Generator Input Parameters” on Page 68.

Data Persistence Test Results File

A link to each test result file generated from each Data Persistence Test is listed below.

[Persistence 1 Test Results File](#)

[Persistence 2 Test Results File](#)

Data Persistence Test Results

Data Persistence Test Results	
Data Persistence Test Run Number: 1	
Total Number of Logical Blocks Written	226,542,208
Total Number of Logical Blocks Verified	145,930,816
Total Number of Logical Blocks that Failed Verification	0
Time Duration for Writing Test Logical Blocks	10 minutes
Size in Bytes of each Logical Block	512
Number of Failed I/O Requests in the process of the Test	0

In some cases the same address was the target of multiple writes, which resulted in more Logical Blocks Written than Logical Blocks Verified. In the case of multiple writes to the same address, the pattern written and verified must be associated with the last write to that address.

PRICED STORAGE CONFIGURATION AVAILABILITY DATE

Clause 9.2.4.9

The committed delivery data for general availability (Availability Date) of all products that comprise the Priced Storage Configuration must be reported. When the Priced Storage Configuration includes products or components with different availability dates, the reported Availability Date must be the date at which all components are committed to be available.

The FDR shall state: "The Priced Storage Configuration, as documented in this Full Disclosure Report will be available for shipment to customers on MMMM DD, YYYY." Where Priced Storage Configuration is the TSC Configuration Name as described in Clause 9.2.4.3.3 and MMMM is the alphanumeric month, DD is the numeric day, and YYYY is the numeric year of the date that the Priced Storage Configuration, as documented, is available for shipment to customers as described above.

The IBM TotalStorage® DS8300 (Release 6.1.600), as documented in this Full Disclosure Report will become available for customer purchase and shipment on January 27, 2006.

PRICING INFORMATION

Clause 9.2.4.11

A statement of the respective calculations for pricing must be included.

Clause 9.2.4.11.3

A list of all differences between the Tested Storage Configuration (TSC) and Priced Storage Configuration must be included.

Pricing information may found in the Tested Storage Configuration Pricing section on page 12. A list of all differences between the Tested Storage Configuration (TSC) and Priced Storage Configuration may be found in the Executive Summary portion of this document on page 12.

ANOMALIES OR IRREGULARITIES

Clause 9.2.4.10

The FDR shall include a clear and complete description of any anomalies or irregularities encountered in the course of executing the SPC-1 benchmark that may in any way call into question the accuracy, verifiability, or authenticity of information published in this FDR.

There were no anomalies or irregularities encountered during the SPC-1 Remote Audit of the IBM TotalStorage® DS8300 (Release 6.1.600).

APPENDIX A: CUSTOMER TUNABLE PARAMETERS AND OPTIONS

No customer tunable parameters or options were changed from their default values.

APPENDIX B: TESTED STORAGE CONFIGURATION (TSC) CREATION

Create the RAID-10 ranks

The first script, `step1_mkarray.txt`, groups the physical volumes into 64 RAID-10 arrays and the system automatically generates a set of array names, A0-A63. The next script, `step2_mkanks.txt`, defines the arrays, A0-A63, as 64 open system ranks, R0-R63. As in the previous script, the rank names are assigned by the system. The third script, `step3_rankpool1.txt`, defines the ranks, R0-R63 to comprise a set of 64 “extent pools” (pools of available storage) with the names P0-P63.

step1_mkarray.txt

```
mkarray -dev IBM.2107-7580641 -raidtype 10 -arsite S1
mkarray -dev IBM.2107-7580641 -raidtype 10 -arsite S2
mkarray -dev IBM.2107-7580641 -raidtype 10 -arsite S3
mkarray -dev IBM.2107-7580641 -raidtype 10 -arsite S4
mkarray -dev IBM.2107-7580641 -raidtype 10 -arsite S5
mkarray -dev IBM.2107-7580641 -raidtype 10 -arsite S6
mkarray -dev IBM.2107-7580641 -raidtype 10 -arsite S7
mkarray -dev IBM.2107-7580641 -raidtype 10 -arsite S8
mkarray -dev IBM.2107-7580641 -raidtype 10 -arsite S9
mkarray -dev IBM.2107-7580641 -raidtype 10 -arsite S10
mkarray -dev IBM.2107-7580641 -raidtype 10 -arsite S11
mkarray -dev IBM.2107-7580641 -raidtype 10 -arsite S12
mkarray -dev IBM.2107-7580641 -raidtype 10 -arsite S13
mkarray -dev IBM.2107-7580641 -raidtype 10 -arsite S14
mkarray -dev IBM.2107-7580641 -raidtype 10 -arsite S15
mkarray -dev IBM.2107-7580641 -raidtype 10 -arsite S16
mkarray -dev IBM.2107-7580641 -raidtype 10 -arsite S17
mkarray -dev IBM.2107-7580641 -raidtype 10 -arsite S18
mkarray -dev IBM.2107-7580641 -raidtype 10 -arsite S19
mkarray -dev IBM.2107-7580641 -raidtype 10 -arsite S20
mkarray -dev IBM.2107-7580641 -raidtype 10 -arsite S21
mkarray -dev IBM.2107-7580641 -raidtype 10 -arsite S22
mkarray -dev IBM.2107-7580641 -raidtype 10 -arsite S23
mkarray -dev IBM.2107-7580641 -raidtype 10 -arsite S24
mkarray -dev IBM.2107-7580641 -raidtype 10 -arsite S25
mkarray -dev IBM.2107-7580641 -raidtype 10 -arsite S26
mkarray -dev IBM.2107-7580641 -raidtype 10 -arsite S27
mkarray -dev IBM.2107-7580641 -raidtype 10 -arsite S28
mkarray -dev IBM.2107-7580641 -raidtype 10 -arsite S29
mkarray -dev IBM.2107-7580641 -raidtype 10 -arsite S30
mkarray -dev IBM.2107-7580641 -raidtype 10 -arsite S31
mkarray -dev IBM.2107-7580641 -raidtype 10 -arsite S32
mkarray -dev IBM.2107-7580641 -raidtype 10 -arsite S33
mkarray -dev IBM.2107-7580641 -raidtype 10 -arsite S34
mkarray -dev IBM.2107-7580641 -raidtype 10 -arsite S35
mkarray -dev IBM.2107-7580641 -raidtype 10 -arsite S36
mkarray -dev IBM.2107-7580641 -raidtype 10 -arsite S37
mkarray -dev IBM.2107-7580641 -raidtype 10 -arsite S38
mkarray -dev IBM.2107-7580641 -raidtype 10 -arsite S39
mkarray -dev IBM.2107-7580641 -raidtype 10 -arsite S40
mkarray -dev IBM.2107-7580641 -raidtype 10 -arsite S41
mkarray -dev IBM.2107-7580641 -raidtype 10 -arsite S42
mkarray -dev IBM.2107-7580641 -raidtype 10 -arsite S43
mkarray -dev IBM.2107-7580641 -raidtype 10 -arsite S44
mkarray -dev IBM.2107-7580641 -raidtype 10 -arsite S45
mkarray -dev IBM.2107-7580641 -raidtype 10 -arsite S46
mkarray -dev IBM.2107-7580641 -raidtype 10 -arsite S47
```

```
mkarray -dev IBM.2107-7580641 -raidtype 10 -arsite S48
mkarray -dev IBM.2107-7580641 -raidtype 10 -arsite S49
mkarray -dev IBM.2107-7580641 -raidtype 10 -arsite S50
mkarray -dev IBM.2107-7580641 -raidtype 10 -arsite S51
mkarray -dev IBM.2107-7580641 -raidtype 10 -arsite S52
mkarray -dev IBM.2107-7580641 -raidtype 10 -arsite S53
mkarray -dev IBM.2107-7580641 -raidtype 10 -arsite S54
mkarray -dev IBM.2107-7580641 -raidtype 10 -arsite S55
mkarray -dev IBM.2107-7580641 -raidtype 10 -arsite S56
mkarray -dev IBM.2107-7580641 -raidtype 10 -arsite S57
mkarray -dev IBM.2107-7580641 -raidtype 10 -arsite S58
mkarray -dev IBM.2107-7580641 -raidtype 10 -arsite S59
mkarray -dev IBM.2107-7580641 -raidtype 10 -arsite S60
mkarray -dev IBM.2107-7580641 -raidtype 10 -arsite S61
mkarray -dev IBM.2107-7580641 -raidtype 10 -arsite S62
mkarray -dev IBM.2107-7580641 -raidtype 10 -arsite S63
mkarray -dev IBM.2107-7580641 -raidtype 10 -arsite S64

lsarray -dev IBM.2107-7580641 -1
```

step2_mkranks.txt

```
# Make a rank (R0-R16 will be created)
mkrank -dev IBM.2107-7580641 -array A0 -stgtype fb
mkrank -dev IBM.2107-7580641 -array A1 -stgtype fb
mkrank -dev IBM.2107-7580641 -array A2 -stgtype fb
mkrank -dev IBM.2107-7580641 -array A3 -stgtype fb
mkrank -dev IBM.2107-7580641 -array A4 -stgtype fb
mkrank -dev IBM.2107-7580641 -array A5 -stgtype fb
mkrank -dev IBM.2107-7580641 -array A6 -stgtype fb
mkrank -dev IBM.2107-7580641 -array A7 -stgtype fb
mkrank -dev IBM.2107-7580641 -array A8 -stgtype fb
mkrank -dev IBM.2107-7580641 -array A9 -stgtype fb
mkrank -dev IBM.2107-7580641 -array A10 -stgtype fb
mkrank -dev IBM.2107-7580641 -array A11 -stgtype fb
mkrank -dev IBM.2107-7580641 -array A12 -stgtype fb
mkrank -dev IBM.2107-7580641 -array A13 -stgtype fb
mkrank -dev IBM.2107-7580641 -array A14 -stgtype fb
mkrank -dev IBM.2107-7580641 -array A15 -stgtype fb
mkrank -dev IBM.2107-7580641 -array A16 -stgtype fb
mkrank -dev IBM.2107-7580641 -array A18 -stgtype fb
mkrank -dev IBM.2107-7580641 -array A17 -stgtype fb
mkrank -dev IBM.2107-7580641 -array A19 -stgtype fb
mkrank -dev IBM.2107-7580641 -array A20 -stgtype fb
mkrank -dev IBM.2107-7580641 -array A21 -stgtype fb
mkrank -dev IBM.2107-7580641 -array A22 -stgtype fb
mkrank -dev IBM.2107-7580641 -array A23 -stgtype fb
mkrank -dev IBM.2107-7580641 -array A24 -stgtype fb
mkrank -dev IBM.2107-7580641 -array A25 -stgtype fb
mkrank -dev IBM.2107-7580641 -array A26 -stgtype fb
mkrank -dev IBM.2107-7580641 -array A27 -stgtype fb
mkrank -dev IBM.2107-7580641 -array A28 -stgtype fb
mkrank -dev IBM.2107-7580641 -array A29 -stgtype fb
mkrank -dev IBM.2107-7580641 -array A30 -stgtype fb
mkrank -dev IBM.2107-7580641 -array A31 -stgtype fb
mkrank -dev IBM.2107-7580641 -array A32 -stgtype fb
mkrank -dev IBM.2107-7580641 -array A33 -stgtype fb
mkrank -dev IBM.2107-7580641 -array A34 -stgtype fb
mkrank -dev IBM.2107-7580641 -array A35 -stgtype fb
mkrank -dev IBM.2107-7580641 -array A36 -stgtype fb
mkrank -dev IBM.2107-7580641 -array A37 -stgtype fb
mkrank -dev IBM.2107-7580641 -array A38 -stgtype fb
```

```
mkrank -dev IBM.2107-7580641 -array A39 -stgtype fb
mkrank -dev IBM.2107-7580641 -array A40 -stgtype fb
mkrank -dev IBM.2107-7580641 -array A41 -stgtype fb
mkrank -dev IBM.2107-7580641 -array A42 -stgtype fb
mkrank -dev IBM.2107-7580641 -array A43 -stgtype fb
mkrank -dev IBM.2107-7580641 -array A44 -stgtype fb
mkrank -dev IBM.2107-7580641 -array A45 -stgtype fb
mkrank -dev IBM.2107-7580641 -array A46 -stgtype fb
mkrank -dev IBM.2107-7580641 -array A47 -stgtype fb
mkrank -dev IBM.2107-7580641 -array A48 -stgtype fb
mkrank -dev IBM.2107-7580641 -array A60 -stgtype fb
mkrank -dev IBM.2107-7580641 -array A50 -stgtype fb
mkrank -dev IBM.2107-7580641 -array A51 -stgtype fb
mkrank -dev IBM.2107-7580641 -array A49 -stgtype fb
mkrank -dev IBM.2107-7580641 -array A61 -stgtype fb
mkrank -dev IBM.2107-7580641 -array A62 -stgtype fb
mkrank -dev IBM.2107-7580641 -array A63 -stgtype fb
mkrank -dev IBM.2107-7580641 -array A52 -stgtype fb
mkrank -dev IBM.2107-7580641 -array A53 -stgtype fb
mkrank -dev IBM.2107-7580641 -array A54 -stgtype fb
mkrank -dev IBM.2107-7580641 -array A55 -stgtype fb
mkrank -dev IBM.2107-7580641 -array A56 -stgtype fb
mkrank -dev IBM.2107-7580641 -array A57 -stgtype fb
mkrank -dev IBM.2107-7580641 -array A58 -stgtype fb
mkrank -dev IBM.2107-7580641 -array A59 -stgtype fb
```

step3_rankpool.txt

```
chrank -dev IBM.2107-7580641 -extpool P0 R0
chrank -dev IBM.2107-7580641 -extpool P1 R1
chrank -dev IBM.2107-7580641 -extpool P2 R2
chrank -dev IBM.2107-7580641 -extpool P3 R3
chrank -dev IBM.2107-7580641 -extpool P4 R4
chrank -dev IBM.2107-7580641 -extpool P5 R5
chrank -dev IBM.2107-7580641 -extpool P6 R6
chrank -dev IBM.2107-7580641 -extpool P7 R7
chrank -dev IBM.2107-7580641 -extpool P8 R8
chrank -dev IBM.2107-7580641 -extpool P9 R9
chrank -dev IBM.2107-7580641 -extpool P10 R10
chrank -dev IBM.2107-7580641 -extpool P11 R11
chrank -dev IBM.2107-7580641 -extpool P12 R12
chrank -dev IBM.2107-7580641 -extpool P13 R13
chrank -dev IBM.2107-7580641 -extpool P14 R14
chrank -dev IBM.2107-7580641 -extpool P15 R15
chrank -dev IBM.2107-7580641 -extpool P16 R16
chrank -dev IBM.2107-7580641 -extpool P17 R17
chrank -dev IBM.2107-7580641 -extpool P18 R18
chrank -dev IBM.2107-7580641 -extpool P19 R19
chrank -dev IBM.2107-7580641 -extpool P20 R20
chrank -dev IBM.2107-7580641 -extpool P21 R21
chrank -dev IBM.2107-7580641 -extpool P22 R22
chrank -dev IBM.2107-7580641 -extpool P23 R23
chrank -dev IBM.2107-7580641 -extpool P24 R24
chrank -dev IBM.2107-7580641 -extpool P25 R25
chrank -dev IBM.2107-7580641 -extpool P26 R26
chrank -dev IBM.2107-7580641 -extpool P27 R27
chrank -dev IBM.2107-7580641 -extpool P28 R28
chrank -dev IBM.2107-7580641 -extpool P29 R29
chrank -dev IBM.2107-7580641 -extpool P30 R30
chrank -dev IBM.2107-7580641 -extpool P31 R31
chrank -dev IBM.2107-7580641 -extpool P32 R32
chrank -dev IBM.2107-7580641 -extpool P33 R33
```

```
chrank -dev IBM.2107-7580641 -extpool P34 R34
chrank -dev IBM.2107-7580641 -extpool P35 R35
chrank -dev IBM.2107-7580641 -extpool P36 R36
chrank -dev IBM.2107-7580641 -extpool P37 R37
chrank -dev IBM.2107-7580641 -extpool P38 R38
chrank -dev IBM.2107-7580641 -extpool P39 R39
chrank -dev IBM.2107-7580641 -extpool P40 R40
chrank -dev IBM.2107-7580641 -extpool P41 R41
chrank -dev IBM.2107-7580641 -extpool P42 R42
chrank -dev IBM.2107-7580641 -extpool P43 R43
chrank -dev IBM.2107-7580641 -extpool P44 R44
chrank -dev IBM.2107-7580641 -extpool P45 R45
chrank -dev IBM.2107-7580641 -extpool P46 R46
chrank -dev IBM.2107-7580641 -extpool P47 R47
chrank -dev IBM.2107-7580641 -extpool P48 R48
chrank -dev IBM.2107-7580641 -extpool P49 R49
chrank -dev IBM.2107-7580641 -extpool P50 R50
chrank -dev IBM.2107-7580641 -extpool P51 R51
chrank -dev IBM.2107-7580641 -extpool P52 R52
chrank -dev IBM.2107-7580641 -extpool P53 R53
chrank -dev IBM.2107-7580641 -extpool P54 R54
chrank -dev IBM.2107-7580641 -extpool P55 R55
chrank -dev IBM.2107-7580641 -extpool P56 R56
chrank -dev IBM.2107-7580641 -extpool P57 R57
chrank -dev IBM.2107-7580641 -extpool P58 R58
chrank -dev IBM.2107-7580641 -extpool P59 R59
chrank -dev IBM.2107-7580641 -extpool P60 R60
chrank -dev IBM.2107-7580641 -extpool P61 R61
chrank -dev IBM.2107-7580641 -extpool P62 R62
chrank -dev IBM.2107-7580641 -extpool P63 R63
```

Create the LUNs

The `step4_makevols.txt` script defines the 112 LUNs on the set of 64 RAID-10 ranks. The name of a rank identifies the DA to which the rank belongs and also assigns the rank a number, as illustrated by the Benchmark Configuration/Tested Storage Configuration Diagram on page 14. In ranks number 0 or 1, which contains spares, a single LUN of 128 GiB is defined. For all other ranks two LUNs of 128 GiB each are defined. After defining the LUNs, the script assigns each LUN to one of eight volume groups, V1-V8, so that paths can be assigned by groups of volumes.

step4_makevols.txt

```
mkfbvol -dev IBM.2107-7580641 -extpool P0 -type ds -cap 128 -name da0r0_#h 1000
mkfbvol -dev IBM.2107-7580641 -extpool P2 -type ds -cap 128 -name da0r2_#h 1020 1021
mkfbvol -dev IBM.2107-7580641 -extpool P4 -type ds -cap 128 -name da0r4_#h 1040 1041
mkfbvol -dev IBM.2107-7580641 -extpool P6 -type ds -cap 128 -name da0r6_#h 1060 1061
mkfbvol -dev IBM.2107-7580641 -extpool P1 -type ds -cap 128 -name da0r1_#h 1100
mkfbvol -dev IBM.2107-7580641 -extpool P3 -type ds -cap 128 -name da0r3_#h 1120 1121
mkfbvol -dev IBM.2107-7580641 -extpool P5 -type ds -cap 128 -name da0r5_#h 1140 1141
mkfbvol -dev IBM.2107-7580641 -extpool P7 -type ds -cap 128 -name da0r7_#h 1160 1161
mkfbvol -dev IBM.2107-7580641 -extpool P8 -type ds -cap 128 -name dalr0_#h 1200
mkfbvol -dev IBM.2107-7580641 -extpool P10 -type ds -cap 128 -name dalr2_#h 1220 1221
mkfbvol -dev IBM.2107-7580641 -extpool P12 -type ds -cap 128 -name dalr4_#h 1240 1241
mkfbvol -dev IBM.2107-7580641 -extpool P14 -type ds -cap 128 -name dalr6_#h 1260 1261
mkfbvol -dev IBM.2107-7580641 -extpool P9 -type ds -cap 128 -name dalr1_#h 1300
mkfbvol -dev IBM.2107-7580641 -extpool P11 -type ds -cap 128 -name dalr3_#h 1320 1321
mkfbvol -dev IBM.2107-7580641 -extpool P13 -type ds -cap 128 -name dalr5_#h 1340 1341
mkfbvol -dev IBM.2107-7580641 -extpool P15 -type ds -cap 128 -name dalr7_#h 1360 1361
```

```
mkfbvol -dev IBM.2107-7580641 -extpool P16 -type ds -cap 128 -name da2r0_#h 1400
mkfbvol -dev IBM.2107-7580641 -extpool P18 -type ds -cap 128 -name da2r2_#h 1420 1421
mkfbvol -dev IBM.2107-7580641 -extpool P20 -type ds -cap 128 -name da2r4_#h 1440 1441
mkfbvol -dev IBM.2107-7580641 -extpool P22 -type ds -cap 128 -name da2r6_#h 1460 1461
mkfbvol -dev IBM.2107-7580641 -extpool P17 -type ds -cap 128 -name da2r1_#h 1500
mkfbvol -dev IBM.2107-7580641 -extpool P19 -type ds -cap 128 -name da2r3_#h 1520 1521
mkfbvol -dev IBM.2107-7580641 -extpool P21 -type ds -cap 128 -name da2r5_#h 1540 1541
mkfbvol -dev IBM.2107-7580641 -extpool P23 -type ds -cap 128 -name da2r7_#h 1560 1561
mkfbvol -dev IBM.2107-7580641 -extpool P24 -type ds -cap 128 -name da3r0_#h 1600
mkfbvol -dev IBM.2107-7580641 -extpool P26 -type ds -cap 128 -name da3r2_#h 1620 1621
mkfbvol -dev IBM.2107-7580641 -extpool P28 -type ds -cap 128 -name da3r4_#h 1640 1641
mkfbvol -dev IBM.2107-7580641 -extpool P30 -type ds -cap 128 -name da3r6_#h 1660 1661
mkfbvol -dev IBM.2107-7580641 -extpool P25 -type ds -cap 128 -name da3r1_#h 1700
mkfbvol -dev IBM.2107-7580641 -extpool P27 -type ds -cap 128 -name da3r3_#h 1720 1721
mkfbvol -dev IBM.2107-7580641 -extpool P29 -type ds -cap 128 -name da3r5_#h 1740 1741
mkfbvol -dev IBM.2107-7580641 -extpool P31 -type ds -cap 128 -name da3r7_#h 1760 1761
mkfbvol -dev IBM.2107-7580641 -extpool P32 -type ds -cap 128 -name da4r0_#h 1800
mkfbvol -dev IBM.2107-7580641 -extpool P34 -type ds -cap 128 -name da4r2_#h 1820 1821
mkfbvol -dev IBM.2107-7580641 -extpool P36 -type ds -cap 128 -name da4r4_#h 1840 1841
mkfbvol -dev IBM.2107-7580641 -extpool P38 -type ds -cap 128 -name da4r6_#h 1860 1861
mkfbvol -dev IBM.2107-7580641 -extpool P33 -type ds -cap 128 -name da4r1_#h 1900
mkfbvol -dev IBM.2107-7580641 -extpool P35 -type ds -cap 128 -name da4r3_#h 1920 1921
mkfbvol -dev IBM.2107-7580641 -extpool P37 -type ds -cap 128 -name da4r5_#h 1940 1941
mkfbvol -dev IBM.2107-7580641 -extpool P39 -type ds -cap 128 -name da4r7_#h 1960 1961
mkfbvol -dev IBM.2107-7580641 -extpool P40 -type ds -cap 128 -name da5r0_#h 1A00
mkfbvol -dev IBM.2107-7580641 -extpool P42 -type ds -cap 128 -name da5r2_#h 1A20 1A21
mkfbvol -dev IBM.2107-7580641 -extpool P44 -type ds -cap 128 -name da5r4_#h 1A40 1A41
mkfbvol -dev IBM.2107-7580641 -extpool P46 -type ds -cap 128 -name da5r6_#h 1A60 1A61
mkfbvol -dev IBM.2107-7580641 -extpool P41 -type ds -cap 128 -name da5r1_#h 1B00
mkfbvol -dev IBM.2107-7580641 -extpool P43 -type ds -cap 128 -name da5r3_#h 1B20 1B21
mkfbvol -dev IBM.2107-7580641 -extpool P45 -type ds -cap 128 -name da5r5_#h 1B40 1B41
mkfbvol -dev IBM.2107-7580641 -extpool P47 -type ds -cap 128 -name da5r7_#h 1B60 1B61
mkfbvol -dev IBM.2107-7580641 -extpool P48 -type ds -cap 128 -name da6r0_#h 1C00
mkfbvol -dev IBM.2107-7580641 -extpool P50 -type ds -cap 128 -name da6r2_#h 1C20 1C21
mkfbvol -dev IBM.2107-7580641 -extpool P52 -type ds -cap 128 -name da6r4_#h 1C40 1C41
mkfbvol -dev IBM.2107-7580641 -extpool P54 -type ds -cap 128 -name da6r6_#h 1C60 1C61
mkfbvol -dev IBM.2107-7580641 -extpool P49 -type ds -cap 128 -name da6r1_#h 1D00
mkfbvol -dev IBM.2107-7580641 -extpool P51 -type ds -cap 128 -name da6r3_#h 1D20 1D21
mkfbvol -dev IBM.2107-7580641 -extpool P53 -type ds -cap 128 -name da6r5_#h 1D40 1D41
mkfbvol -dev IBM.2107-7580641 -extpool P55 -type ds -cap 128 -name da6r7_#h 1D60 1D61
mkfbvol -dev IBM.2107-7580641 -extpool P56 -type ds -cap 128 -name da7r0_#h 1E00
mkfbvol -dev IBM.2107-7580641 -extpool P58 -type ds -cap 128 -name da7r2_#h 1E20 1E21
mkfbvol -dev IBM.2107-7580641 -extpool P60 -type ds -cap 128 -name da7r4_#h 1E40 1E41
mkfbvol -dev IBM.2107-7580641 -extpool P62 -type ds -cap 128 -name da7r6_#h 1E60 1E61
mkfbvol -dev IBM.2107-7580641 -extpool P57 -type ds -cap 128 -name da7r1_#h 1F00
mkfbvol -dev IBM.2107-7580641 -extpool P59 -type ds -cap 128 -name da7r3_#h 1F20 1F21
mkfbvol -dev IBM.2107-7580641 -extpool P61 -type ds -cap 128 -name da7r5_#h 1F40 1F41
mkfbvol -dev IBM.2107-7580641 -extpool P63 -type ds -cap 128 -name da7r7_#h 1F60 1F61
mkvolgrp -dev IBM.2107-7580641 -hosttype pSeries V1
mkvolgrp -dev IBM.2107-7580641 -hosttype pSeries V2
mkvolgrp -dev IBM.2107-7580641 -hosttype pSeries V3
mkvolgrp -dev IBM.2107-7580641 -hosttype pSeries V4
mkvolgrp -dev IBM.2107-7580641 -hosttype pSeries V5
mkvolgrp -dev IBM.2107-7580641 -hosttype pSeries V6
mkvolgrp -dev IBM.2107-7580641 -hosttype pSeries V7
mkvolgrp -dev IBM.2107-7580641 -hosttype pSeries V8
chvolgrp -dev IBM.2107-7580641 -name rio_port_A -action replace -volume
1000,1020,1021,1040,1041,1060,1061,1200,1220,1221,1240,1241,1260,1261 V1
chvolgrp -dev IBM.2107-7580641 -name rio_port_B -action replace -volume
1800,1820,1821,1840,1841,1860,1861,1A00,1A20,1A21,1A40,1A41,1A60,1A61 V2
chvolgrp -dev IBM.2107-7580641 -name rio_port_C -action replace -volume
1D00,1D20,1D21,1D40,1D41,1D60,1D61,1F00,1F20,1F21,1F40,1F41,1F60,1F61 V3
```

```
chvolgrp -dev IBM.2107-7580641 -name rio_port_D -action replace -volume
1500,1520,1521,1540,1541,1560,1561,1700,1720,1721,1740,1741,1760,1761 V4
chvolgrp -dev IBM.2107-7580641 -name rio_port_E -action replace -volume
1C00,1C20,1C21,1C40,1C41,1C60,1C61,1E00,1E20,1E21,1E40,1E41,1E60,1E61 V5
chvolgrp -dev IBM.2107-7580641 -name rio_port_F -action replace -volume
1400,1420,1421,1440,1441,1460,1461,1600,1620,1621,1640,1641,1660,1661 V6
chvolgrp -dev IBM.2107-7580641 -name rio_port_G -action replace -volume
1100,1120,1121,1140,1141,1160,1161,1300,1320,1321,1340,1341,1360,1361 V7
chvolgrp -dev IBM.2107-7580641 -name rio_port_H -action replace -volume
1900,1920,1921,1940,1941,1960,1961,1B00,1B20,1B21,1B40,1B41,1B60,1B61 V8
```

Define the LUN access paths

The next step is to define the paths by which each LUN can be accessed by the Host System. The path definitions are created by the `step5_define_paths.txt` script. Each host WWPN is assigned to one of the eight volume groups, V1-V8, so that each LUN is access via a set of four paths.

step5_define_paths.txt

```
# Make SCSI host ports and assign a volume group to them.
#Perfss10 Config:

mkhostconnect -dev IBM.2107-7580641 -wwname 10000000C944431B -profile "IBM pSeries -
AIX" -volgrp V8 sh2d_fcs0_G1_fc0112
mkhostconnect -dev IBM.2107-7580641 -wwname 10000000C9424FD5 -profile "IBM pSeries -
AIX" -volgrp V7 sh2d_fcs1_H1_fc0502
mkhostconnect -dev IBM.2107-7580641 -wwname 10000000C94259CC -profile "IBM pSeries -
AIX" -volgrp V2 sh2d_fcs2_A1_fc0012
mkhostconnect -dev IBM.2107-7580641 -wwname 10000000C942518A -profile "IBM pSeries -
AIX" -volgrp V6 sh2d_fcs3_E1_fc0602
mkhostconnect -dev IBM.2107-7580641 -wwname 10000000C94030FD -profile "IBM pSeries -
AIX" -volgrp V1 sh2d_fcs4_B1_fc0402
mkhostconnect -dev IBM.2107-7580641 -wwname 10000000C942498B -profile "IBM pSeries -
AIX" -volgrp V4 sh2d_fcs5_C1_fc0712
mkhostconnect -dev IBM.2107-7580641 -wwname 10000000C94256F7 -profile "IBM pSeries -
AIX" -volgrp V5 sh2d_fcs6_F1_fc0212
mkhostconnect -dev IBM.2107-7580641 -wwname 10000000C9427F7E -profile "IBM pSeries -
AIX" -volgrp V3 sh2d_fcs7_D1_fc0312
mkhostconnect -dev IBM.2107-7580641 -wwname 10000000C9444479 -profile "IBM pSeries -
AIX" -volgrp V8 sh2d_fcs8_G3_fc0142
mkhostconnect -dev IBM.2107-7580641 -wwname 10000000C944446C -profile "IBM pSeries -
AIX" -volgrp V7 sh2d_fcs9_H3_fc0542
mkhostconnect -dev IBM.2107-7580641 -wwname 10000000C94443C8 -profile "IBM pSeries -
AIX" -volgrp V2 sh2d_fcs10_A3_fc0042
mkhostconnect -dev IBM.2107-7580641 -wwname 10000000C9444524 -profile "IBM pSeries -
AIX" -volgrp V6 sh2d_fcs11_E3_fc0642
mkhostconnect -dev IBM.2107-7580641 -wwname 10000000C94440F4 -profile "IBM pSeries -
AIX" -volgrp V1 sh2d_fcs12_B3_fc0442
mkhostconnect -dev IBM.2107-7580641 -wwname 10000000C9403183 -profile "IBM pSeries -
AIX" -volgrp V4 sh2d_fcs13_C3_fc0732
mkhostconnect -dev IBM.2107-7580641 -wwname 10000000C9427A39 -profile "IBM pSeries -
AIX" -volgrp V5 sh2d_fcs14_F3_fc0242
mkhostconnect -dev IBM.2107-7580641 -wwname 10000000C942E674 -profile "IBM pSeries -
AIX" -volgrp V3 sh2d_fcs15_D3_fc0342
mkhostconnect -dev IBM.2107-7580641 -wwname 10000000C944454D -profile "IBM pSeries -
AIX" -volgrp V8 sh2d_fcs16_G4_fc0143
mkhostconnect -dev IBM.2107-7580641 -wwname 10000000C94079D7 -profile "IBM pSeries -
AIX" -volgrp V7 sh2d_fcs17_H4_fc0543
mkhostconnect -dev IBM.2107-7580641 -wwname 10000000C94443C9 -profile "IBM pSeries -
AIX" -volgrp V2 sh2d_fcs18_A4_fc0043
```

```
mkhostconnect -dev IBM.2107-7580641 -wwname 10000000C9427DB5 -profile "IBM pSeries -  
AIX" -volgrp V6 sh2d_fcs19_E4_fc0643  
mkhostconnect -dev IBM.2107-7580641 -wwname 10000000C94443C0 -profile "IBM pSeries -  
AIX" -volgrp V1 sh2d_fcs20_B4_fc0443  
mkhostconnect -dev IBM.2107-7580641 -wwname 10000000C9444199 -profile "IBM pSeries -  
AIX" -volgrp V4 sh2d_fcs21_C4_fc0733  
mkhostconnect -dev IBM.2107-7580641 -wwname 10000000C944425F -profile "IBM pSeries -  
AIX" -volgrp V5 sh2d_fcs22_F4_fc0243  
mkhostconnect -dev IBM.2107-7580641 -wwname 10000000C94443DA -profile "IBM pSeries -  
AIX" -volgrp V3 sh2d_fcs23_D4_fc0343  
mkhostconnect -dev IBM.2107-7580641 -wwname 10000000C94441ED -profile "IBM pSeries -  
AIX" -volgrp V8 sh2d_fcs24_G2_fc0113  
mkhostconnect -dev IBM.2107-7580641 -wwname 10000000C9444428 -profile "IBM pSeries -  
AIX" -volgrp V7 sh2d_fcs25_H2_fc0503  
mkhostconnect -dev IBM.2107-7580641 -wwname 10000000C9427F7F -profile "IBM pSeries -  
AIX" -volgrp V2 sh2d_fcs26_A2_fc0013  
mkhostconnect -dev IBM.2107-7580641 -wwname 10000000C944428C -profile "IBM pSeries -  
AIX" -volgrp V6 sh2d_fcs27_E2_fc0603  
mkhostconnect -dev IBM.2107-7580641 -wwname 10000000C9444204 -profile "IBM pSeries -  
AIX" -volgrp V1 sh2d_fcs28_B2_fc0403  
mkhostconnect -dev IBM.2107-7580641 -wwname 10000000C9402F88 -profile "IBM pSeries -  
AIX" -volgrp V4 sh2d_fcs29_C2_fc0713  
mkhostconnect -dev IBM.2107-7580641 -wwname 10000000C9444156 -profile "IBM pSeries -  
AIX" -volgrp V5 sh2d_fcs30_F2_fc0213  
mkhostconnect -dev IBM.2107-7580641 -wwname 10000000C9444311 -profile "IBM pSeries -  
AIX" -volgrp V3 sh2d_fcs31_D2_fc0313
```

Discover the LUNs and create multi-path hdisks

The `step6_discover.ksh` script performs discovery on each of the 32 Host System paths. In this configuration AIX MPIO capability is utilized creating one multi-path hdisk that corresponds to each LUN.

step6_discover.ksh

```
#Configure Host Adapters for RIO Ports A1 through A4  
for i in 2 26 10 18; do cfgmgr -vl fcs$i|grep Comp; done  
#  
#Configure Host Adapters for RIO Ports B1 through B4  
for i in 4 28 12 20; do cfgmgr -vl fcs$i|grep Comp; done  
#  
#Configure Host Adapters for RIO Ports C1 through C4  
for i in 5 29 13 21; do cfgmgr -vl fcs$i|grep Comp; done  
#  
#Configure Host Adapters for RIO Ports D1 through D4  
for i in 7 31 15 23; do cfgmgr -vl fcs$i|grep Comp; done  
#  
#Configure Host Adapters for RIO Ports E1 through E4  
for i in 3 27 11 19; do cfgmgr -vl fcs$i|grep Comp; done  
#  
#Configure Host Adapters for RIO Ports F1 through F4  
for i in 6 30 14 22; do cfgmgr -vl fcs$i|grep Comp; done  
#  
#Configure Host Adapters for RIO Ports G1 through G4  
for i in 0 24 8 16; do cfgmgr -vl fcs$i|grep Comp; done  
#  
#Configure Host Adapters for RIO Ports H1 through H4  
for i in 1 25 9 17; do cfgmgr -vl fcs$i|grep Comp; done
```

Create logical volume group and logical volumes

A logical volume group is created using the native AIX Logical Volume Manager. It is a striped volume group with a pattern of striping designed so that the amount of space utilized in each rank is proportional to the number of disk in that rank. The pattern of striping is accomplished with the `step7a_mkall.ksh` script, which calls `mkmap.ksh` as a subroutine. Once the striping pattern is defined, the `step7b_mkvg_spc1.ksh` script creates the 18 logical volumes that comprise the SPC-1 ASUs.

step7a_mkall.ksh

```
#!/bin/ksh

LVS=18
i=1
while (( i <= LVS ))
do
    mkmap.ksh $i 9 > map$i
    maps="$maps map$i"
    (( i=i+1 ))
done

paste -d " " "$maps" | more
```

mkmap.ksh

```
#!/bin/ksh
#
# Creates mklv map files for creating spc1 LV config
#
if [ $# -ne 2 ]
then
    echo "usage: $0 <starting PP> <stripes>"
    exit 1
fi

hdisks_3plus="4 11 18 25 32 39 46 53 60 67 74 81 88 95 102 109"

hdisks="4 5 7 9 11 12 14 16 18 19 21 23 25 26 28 30 32 33 35 37 39 40 42 44 46 47 49
51 53 54 56 58 60 61 63 65 67 68 70 72 74 75 77 79 81 82 84 86 88 89 91 93 95 96 98
100 102 103 105 107 109 110 112 114"

starting_pp=$1
stripe_total=$2

j=1
stripes=1
pp3=$starting_pp
pp4=$starting_pp
while (( stripes <= stripe_total ))
do
    for hdisk in $hdisks
    do

# determine if 4+4 or 3+3: plus4=1 is 4+4, plus4=0 is 3+3
        plus4=1
        for z in $hdisks_3plus
        do
            if [ $hdisk -eq $z ]
            then plus4=0
            fi
        done
    done
done
```



```
        fi
    done
    echo "hdisk " $hdisk " " $plus4

    if [ plus4 -eq 0 ]
    then
        print hdisk$hdisk:$pp3
    else
        if [ j -le 2 ]
        then
            print hdisk$hdisk:$pp4
        else
            (( k=pp4+1 ))
            print hdisk$hdisk:$pp4-$k
        fi
    fi
    done
    (( j=j+1 ))
    (( pp3=pp3+18 ))

    if [ j -eq 3 ]
    then
        (( pp4=pp4 + starting_pp - 1 ))
    fi
    if [ j -le 3 ]
    then
        (( pp4=pp4+18 ))
    else
        (( pp4=pp4+37 - starting_pp ))
        j=1
    fi
    (( stripes=stripes+1 ))
done
```

step7b_mkvg_spcl.ksh

```
# creates 18 logical volumes in a volume group with coarse striping

FIRST=4
LAST=115
hdisks=""

i=$FIRST
while [ i -le LAST ]
do
    hdisks="$hdisks hdisk$i"
    (( i=i+1 ))
done

set -x

# mkvg options
# -B bigvg
#   up to 128 physical volumes and 512 logical volumes.
# -f force
# -y VG name
# -d this flag ignored. max physical volumes.
# -s size of physical partition in MB
#   from 1MB to 131072MB
# -S   Creates a Scalable-type volume group. By default, this volume group can
#   accommodate up to 1024 physical volumes, 256 logical volumes and 32768 physical
#   partitions. To increase the number of logical volumes, use the -v option.
```

```
mkvvg -B -f -y stripevg -s 512 $hdisk

#if [[ $? -ne 0 ]] then exit; fi

# mklv options
# -a e
#   place LV on outer edge of disks
# -y LV name
# -x maximum number of logical partitions that can be allocated to the LV.
#   - default 512, max 32,512.
# -u upperbound on number of disks in this LV
#   maximum number of physical volumes for new allocation. The value of the
#   Upperbound variable should be between one and the total number of physical
#   volumes. When using striped logical volumes, the upper bound must be multiple
#   of Stripe_width. If upper_bound is not specified it is assumed to be
stripe_width
#   for striped logical volumes.
# -S Stripe(really strip) Size
#   4K, 8K, 16K, 32K, 64K, 128K, 1M, 2M, 4M, 8M, 16M, 32M, 64M, and 128M
# -C Stripe_width
#   If the Stripe_width is not entered it is assumed to be the upper_bound or the
#   total number of disks specified on the command line.
# -m map_file

i=1
while [[ i -le 18 ]]
do
    mklv -y fat$i -m mkvvg/map$i stripevg 720
    (( i=i+1 ))
done
```

APPENDIX C: SPC-1 WORKLOAD GENERATOR STORAGE COMMANDS AND PARAMETERS

The contents of the SPC-1 Workload Generator command and parameter file, **SPC1.cfg**, is listed below.

```
javaparms="-Xms380m -Xmx768m -Xss128k -Xgcpolicy:optavgpause"  
sd=asu1_1,size=380g,lun=/dev/rfat1  
sd=asu1_2,size=380g,lun=/dev/rfat2  
sd=asu1_3,size=380g,lun=/dev/rfat3  
sd=asu1_4,size=380g,lun=/dev/rfat4  
sd=asu1_5,size=380g,lun=/dev/rfat5  
sd=asu1_6,size=380g,lun=/dev/rfat6  
sd=asu1_7,size=380g,lun=/dev/rfat7  
sd=asu1_8,size=380g,lun=/dev/rfat8  
sd=asu2_1,size=380g,lun=/dev/rfat9  
sd=asu2_2,size=380g,lun=/dev/rfat10  
sd=asu2_3,size=380g,lun=/dev/rfat11  
sd=asu2_4,size=380g,lun=/dev/rfat12  
sd=asu2_5,size=380g,lun=/dev/rfat13  
sd=asu2_6,size=380g,lun=/dev/rfat14  
sd=asu2_7,size=380g,lun=/dev/rfat15  
sd=asu2_8,size=380g,lun=/dev/rfat16  
sd=asu3_1,size=337800m,lun=/dev/rfat17  
sd=asu3_2,size=337800m,lun=/dev/rfat18
```

APPENDIX D: SPC-1 WORKLOAD GENERATOR INPUT PARAMETERS

The following script was used to execute the required SPC-1 Test Runs with the exception of the Persistence Test Run 2, which was executed manually at the console. The contents of the `javaopts.cfg` are also listed below.

```
export PATH=$PATH:/usr/java14/bin
export SPC1HOME=/perform/spclinstall
export CLASSPATH=$SPC1HOME
export LIBPATH=$SPC1HOME/aix
export IBM_JAVADUMP_OUTOFMEMORY=false
export IBM_HEAPDUMP_OUTOFMEMORY=false
java -Xoptionsfile=javaopts.cfg metrics -b 2022
java -Xoptionsfile=javaopts.cfg repeat1 -b 2022
java -Xoptionsfile=javaopts.cfg repeat2 -b 2022
java -Xoptionsfile=javaoptsp.cfg persist1 -b 2022
```

javaopts.cfg:

```
-Xms384m -Xmx768m -Xss128k -Xgcpolicy:subpool
```