



**SPC BENCHMARK 1™**  
**FULL DISCLOSURE REPORT**

**SUN MICROSYSTEMS, INC.**  
**SUN STORAGE TEK®**  
**FLEXLINE™ FLX380 STORAGE SYSTEM**

**SPC-1 V1.9**

**Submitted for Review: May 10, 2005**

**Submission Identifier: A00041**

**Accepted: July 9, 2005**

**Revised: September 5, 2006**



**First Edition – May 2005**

THE INFORMATION CONTAINED IN THIS DOCUMENT IS DISTRIBUTED ON AN AS IS BASIS WITHOUT ANY WARRANTY EITHER EXPRESS OR IMPLIED. The use of this information or the implementation of any of these techniques is the customer's responsibility and depends on the customer's ability to evaluate and integrate them into the customer's operational environment. While each item has been reviewed by Sun Microsystems, Inc. for accuracy in a specific situation, there is no guarantee that the same or similar results will be obtained elsewhere. Customers attempting to adapt these techniques to their own environment do so at their own risk.

This publication was produced in the United States. Sun Microsystems, Inc. may not offer the products, services, or features discussed in this document in other countries, and the information is subject to change with notice. Consult your local Sun Microsystems, Inc. representative for information on products and services available in your area.

© Copyright Sun Microsystems, Inc. 2005. All rights reserved.

Permission is hereby granted to reproduce this document in whole or in part, provided the copyright notice as printed above is set forth in full text on the title page of each item reproduced.

**Trademarks**

SPC Benchmark 1, SPC-1 IOPS, and SPC-1 LRT are trademarks of the Storage Performance Council. StorageTek, the StorageTek logo, and FlexLine are trademarks or registered trademarks of Sun Microsystems, Inc. in the United States and other countries. UNIX is a registered trademark of The Open Group in the United States and other countries. All other brands, trademarks, and product names are the property of their respective owners.

**Notes**

The following terms, used in this document, are defined as:

- Kilobyte (KB) is equal to 1,000 ( $10^3$ ) bytes.
- Megabyte (MB) is equal to 1,000,000 ( $10^6$ ) bytes.
- Gigabyte (GB) is equal to 1,000,000,000 ( $10^9$ ) bytes.
- Terabyte (TB) is equal to 1,000,000,000,000 ( $10^{12}$ ) bytes.
- A petabyte (PB) is equal to 1,000,000,000,000,000 ( $10^{15}$ ) bytes.
- An exabyte (EB) is equal to 1,000,000,000,000,000,000 ( $10^{18}$ ) bytes.

## Table of Contents

|  |             |
|--|-------------|
| <b>Audit Certification</b> .....   | <b>vi</b>   |
| <b>Letter of Good Faith</b> .....  | <b>viii</b> |
| <b>Executive Summary</b> .....   | <b>9</b>    |
| <b>Test Sponsor and Contact Information</b> .....  | <b>9</b>    |
| <b>Revision Information and Key Dates</b> .....  | <b>9</b>    |
| <b>Summary of Results</b> .....  | <b>10</b>   |
| <b>Storage Capacities and Relationships</b> .....  | <b>10</b>   |
| <b>Response Time - Throughput Curve</b> .....  | <b>11</b>   |
| <b>Response Time - Throughput Data</b> .....   | <b>11</b>   |
| <b>Tested Storage Configuration Pricing (<i>Priced Storage Configuration</i>)</b> .....                  | <b>12</b>   |
| <b>Differences between the Tested Storage Configuration (TSC) and Priced Storage Configuration</b> ..... | <b>12</b>   |
| <b>Benchmark Configuration/Tested Storage Configuration Diagram</b> .....                                | <b>13</b>   |
| <b>Configuration Information</b> .....   | <b>14</b>   |
| <b>Benchmark Configuration (BC)/Tested Storage Configuration (TSC) Diagram</b> .....                     | <b>14</b>   |
| <b>Storage Network Configuration</b> .....   | <b>14</b>   |
| <b>Host System Configuration</b> .....   | <b>15</b>   |
| <b>Customer Tunable Parameters and Options</b> .....   | <b>15</b>   |
| <b>Tested Storage Configuration (TSC) Description</b> .....  | <b>15</b>   |
| <b>SPC-1 Workload Generator Storage Configuration</b> .....  | <b>16</b>   |
| <b>Data Repository</b> .....   | <b>17</b>   |
| <b>Definitions</b> .....   | <b>17</b>   |
| <b>Storage Capacities and Relationships</b> .....  | <b>18</b>   |
| SPC-1 Storage Capacities .....   | <b>18</b>   |
| SPC-1 Storage Hierarchy Ratios .....   | <b>18</b>   |
| SPC-1 Storage Capacities and Relationships Illustration .....  | <b>19</b>   |
| <b>Logical Volume Capacity and ASU Mapping</b> .....   | <b>19</b>   |
| <b>SPC-1 Benchmark Execution Results</b> .....   | <b>20</b>   |
| <b>Definitions</b> .....   | <b>20</b>   |
| <b>Primary Metrics Test - Sustainability Test Phase</b> .....  | <b>21</b>   |
| SPC-1 Workload Generator Input Parameters .....  | <b>21</b>   |
| Sustainability Test Results File .....   | <b>21</b>   |
| Sustainability - Data Rate Distribution Data ( <i>MB/second</i> ).....                                   | <b>22</b>   |
| Sustainability - Data Rate Distribution Graph .....  | <b>23</b>   |
| Sustainability - I/O Request Throughput Distribution Data .....  | <b>24</b>   |
| Sustainability - I/O Request Throughput Distribution Graph .....   | <b>25</b>   |

|   |           |
|---|-----------|
| Sustainability – Average Response Time (ms) Distribution Data .....                 | 26        |
| Sustainability – Average Response Time (ms) Distribution Graph .....                | 27        |
| Sustainability – Response Time Frequency Distribution Data .....                    | 28        |
| Sustainability – Response Time Frequency Distribution Graph .....                   | 28        |
| Sustainability – Measured Intensity Multiplier and Coefficient of Variation.....    | 29        |
| <b>Primary Metrics Test – IOPS Test Phase .....</b>                                 | <b>30</b> |
| SPC-1 Workload Generator Input Parameters .....                                     | 30        |
| IOPS Test Results File.....   | 30        |
| IOPS Test Run – I/O Request Throughput Distribution Data .....                      | 31        |
| IOPS Test Run – I/O Request Throughput Distribution Graph.....                      | 31        |
| IOPS Test Run – Response Time Frequency Distribution Data .....                     | 32        |
| IOPS Test Run –Response Time Frequency Distribution Graph.....                      | 32        |
| IOPS Test Run – Average Response Time (ms) Distribution Data .....                  | 33        |
| IOPS Test Run – Average Response Time (ms) Distribution Graph .....                 | 33        |
| IOPS Test Run – I/O Request Information.....  | 34        |
| IOPS Test Run – Measured Intensity Multiplier and Coefficient of Variation.....     | 34        |
| <b>Primary Metrics Test – Response Time Ramp Test Phase .....</b>                   | <b>35</b> |
| SPC-1 Workload Generator Input Parameters .....                                     | 35        |
| Response Time Ramp Test Results File.....   | 35        |
| Response Time Ramp Distribution (IOPS) Data.....                                    | 36        |
| Response Time Ramp Distribution (IOPS) Graph .....                                  | 37        |
| SPC-1 LRT™ Average Response Time (ms) Distribution Data.....                        | 38        |
| SPC-1 LRT™ Average Response Time (ms) Distribution Graph .....                      | 38        |
| SPC-1 LRT™ (10%) – Measured Intensity Multiplier and Coefficient of Variation ..... | 39        |
| <b>Repeatability Test.....</b>  | <b>40</b> |
| SPC-1 Workload Generator Input Parameters .....                                     | 40        |
| Repeatability Test Results File .....   | 41        |
| Repeatability 1 LRT – I/O Request Throughput Distribution Data.....                 | 42        |
| Repeatability 1 LRT – I/O Request Throughput Distribution Graph .....               | 42        |
| Repeatability 1 LRT –Average Response Time (ms) Distribution Data .....             | 43        |
| Repeatability 1 LRT –Average Response Time (ms) Distribution Graph.....             | 43        |
| Repeatability 1 IOPS – I/O Request Throughput Distribution Data .....               | 44        |
| Repeatability 1 IOPS – I/O Request Throughput Distribution Graph.....               | 44        |
| Repeatability 1 IOPS –Average Response Time (ms) Distribution Data.....             | 45        |
| Repeatability 1 IOPS –Average Response Time (ms) Distribution Graph .....           | 45        |
| Repeatability 2 LRT – I/O Request Throughput Distribution Data.....                 | 46        |
| Repeatability 2 LRT – I/O Request Throughput Distribution Graph .....               | 46        |
| Repeatability 2 LRT –Average Response Time (ms) Distribution Data .....             | 47        |
| Repeatability 2 LRT –Average Response Time (ms) Distribution Graph.....             | 47        |

|  |           |
|--|-----------|
| Repeatability 2 IOPS – I/O Request Throughput Distribution Data .....                  | 48        |
| Repeatability 2 IOPS – I/O Request Throughput Distribution Graph.....                  | 48        |
| Repeatability 2 IOPS –Average Response Time (ms) Distribution Data.....                | 49        |
| Repeatability 2 IOPS –Average Response Time (ms) Distribution Graph .....              | 49        |
| Repeatability 1 (LRT) Measured Intensity Multiplier and Coefficient of Variation.....  | 50        |
| Repeatability 1 (IOPS) Measured Intensity Multiplier and Coefficient of Variation .... | 50        |
| Repeatability 2 (LRT) Measured Intensity Multiplier and Coefficient of Variation ..... | 50        |
| Repeatability 2 (IOPS) Measured Intensity Multiplier and Coefficient of Variation .... | 51        |
| <b>Data Persistence Test.....</b>  | <b>52</b> |
| SPC-1 Workload Generator Input Parameters .....  | 52        |
| Data Persistence Test Results File .....   | 52        |
| Data Persistence Test Results.....   | 53        |
| <b>Priced Storage Configuration Availability Date.....</b>                             | <b>54</b> |
| <b>Pricing Information.....</b>  | <b>54</b> |
| <b>Anomalies or Irregularities .....</b>   | <b>54</b> |
| <b>Appendix A: Customer Tunable Parameters and Options.....</b>                        | <b>55</b> |
| <b>Windows 2000 Registry Changes .....</b>   | <b>55</b> |
| <b>Storage Array Cache Flush Settings.....</b>   | <b>55</b> |
| <b>RDAC Failover Options.....</b>  | <b>55</b> |
| <b>Host Bus Adapter Options.....</b>   | <b>56</b> |
| <b>Appendix B: Tested Storage Configuration (TSC) Creation .....</b>                   | <b>57</b> |
| <b>SANtricity Volume Creation Script .....</b>   | <b>58</b> |
| <b>Appendix C: SPC-1 Workload Generator Storage Commands and<br/>Parameters .....</b>  | <b>61</b> |
| <b>Master Host System .....</b>  | <b>61</b> |
| <b>Slave Host Systems .....</b>  | <b>61</b> |

## AUDIT CERTIFICATION



Jaye L. Alynn  
Storage Technology Corporation  
1 StorageTek Drive  
Louisville, Co 80028

May 9, 2005

The SPC Benchmark 1™ results listed below for the StorageTek® FlexLine™ FLX380 Storage System were produced in compliance with the SPC Benchmark 1™ V1.9 Remote Audit requirements.

| SPC Benchmark 1™ V1.9 Results                      |                     |
|--|---------------------|
| Tested Storage Configuration (TSC) Name:           |                     |
| StorageTek® FlexLine™ FLX380 Storage System        |                     |
| Metric   | Reported Result     |
| SPC-1 IOPS™  | 42,254.07           |
| SPC-1 Price-Performance                            | \$15.75/SPC-1 IOPS™ |
| Total ASU Capacity                                 | 6,871,109 GB        |
| Data Protection Level                              | Mirroring           |
| Total TSC Price (including three-year maintenance) | \$665,596           |

The following SPC Benchmark 1™ Remote Audit requirements were reviewed and found compliant with V1.9 of the SPC Benchmark 1™ specification:

- A Letter of Good Faith, signed by a senior executive.
- The following Data Repository storage items were verified using information supplied by Storage Technology Corporation:
  - ✓ Physical Storage Capacity and requirements.
  - ✓ Configured Storage Capacity and requirements.
  - ✓ Addressable Storage Capacity and requirements.
  - ✓ Capacity of each Logical Volume and requirements.
  - ✓ Capacity of each Application Storage Unit (ASU) and requirements.
- An appropriate diagram of the Benchmark Configuration (BC)/Tested Storage Configuration (TSC).
- Listings and commands to configure the Benchmark Configuration/Tested Storage Configuration, including customer tunable parameters.

Storage Performance Council  
643 Bair Island Road, Suite 103  
Redwood City, CA 94062  
[AuditService@storageperformance.org](mailto:AuditService@storageperformance.org)  
650.556.9384

- Commands and parameters used to configure the SPC-1 Workload Generator.
- The following Host System requirements were reviewed using documentation supplied by Storage Technology Corporation:
  - ✓ The type of Host System including the number of processors and main memory.
  - ✓ The presence and version number of the Workload Generator on the Host System.
  - ✓ The TSC boundary within the Host System.
- The Test Results Files and resultant Summary Results Files received from Storage Technology Corporation for each of following were authentic, accurate, and compliant with all of the requirements and constraints of Clauses 4 and 5 of the SPC-1 Benchmark Specification:
  - ✓ Data Persistence Test
  - ✓ Sustainability Test Phase
  - ✓ IOPS Test Phase
  - ✓ Response Time Ramp Test Phase
  - ✓ Repeatability Test
- The differences between the Tested Storage Configuration (TSC) used for the benchmark and Priced Storage Configuration are noted below.
- The final version of the pricing spreadsheet met all of the requirements and constraints of Clause 8 of the SPC-1 Benchmark Specification.
- The Full Disclosure Report (FDR) met all of the requirements in Clause 9 of the SPC-1 Benchmark Specification.

**Audit Notes:**

The Brocade SilkWorm 4100 switch used in the TSC was configured with 32 ports and 32 SFP transceivers. The benchmark measurement only used 24 ports and corresponding transceivers. The Brocade SilkWorm 4100 switch in the Priced Storage Configuration is configured with 24 ports and 24 SFP transceivers. If the TSC had used the switch configured with only 24 ports and transceivers, there would have not been any negative impact on the reported SPC-1 measurements.

Respectfully,

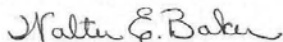

Walter E. Baker  
SPC Auditor

Storage Performance Council  
643 Bair Island Road, Suite 103  
Redwood City, CA 94062  
[AuditService@storageperformance.org](mailto:AuditService@storageperformance.org)  
650 556 9384

**LETTER OF GOOD FAITH**

Storage Technology Corporation 303.673.5151 phone  
One StorageTek Drive  
Louisville, CO 80028



Date: 14 April 2005

From: Peter K. Wu, VP Engineering  
One StorageTek Drive  
Louisville, CO 80028

To: Walter E. Baker, SPC Auditor  
Gradient Systems, Inc.  
643 Bair Island Road, Suite 103  
Redwood City, CA 94063-2755

Subject: SPC-1 Letter of Good Faith for the FLX380  
StorageTek Corporation is the SPC-1 Test Sponsor for the above listed product.  
To the best of our knowledge and belief, the required SPC-1 benchmark results  
and materials we have submitted for that product are complete, accurate, and in  
full compliance with the V1.8.0 of the SPC-1 benchmark specification.

In addition, we have reported any items in the Benchmark Configuration and  
execution of the benchmark that affected the reported results even if the items  
are not explicitly required to be disclosed by the SPC-1 benchmark  
specification.

Signed:

Date:

  
Peter K. Wu  
VP, StorageTek Corp. Engineering

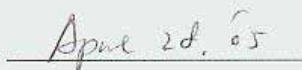
  
April 28, 05

INFORMATION  POWERFUL



## **EXECUTIVE SUMMARY**

### **Test Sponsor and Contact Information**

| <b>Test Sponsor and Contact Information</b> |  |
|---|--|
| <b>Test Sponsor<br/>Primary Contact</b>     | Sun Microsystems, Inc. – <a href="http://www.sun.com">http://www.sun.com</a><br>Leah Schoeb – <a href="mailto:leah.schoeb@sun.com">leah.schoeb@sun.com</a><br>5300 Riata Park Court AUS08<br>Austin, TX 78721<br>Phone: (512) 401-1227<br>FAX: (512) 266-2523  |
| <b>Test Sponsor<br/>Alternate Contact</b>   | Sun Microsystems, Inc. – <a href="http://www.sun.com">http://www.sun.com</a><br>Jason Scaffer – <a href="mailto:Jason.schaffer@sun.com">Jason.schaffer@sun.com</a><br>500 Eldorado Blvd., UBRM05-211<br>Broomfield, CO 80021<br>Phone: (303) 272-4743<br>FAX: (303) 272-3136   |
| <b>Auditor</b>                              | Storage Performance Council – <a href="http://www.StoragePerformance.org">http://www.StoragePerformance.org</a><br>Walter E. Baker – <a href="mailto:AuditService@StoragePerformance.org">AuditService@StoragePerformance.org</a><br>643 Bair Island Road, Suite 103<br>Redwood City, CA 94063<br>Phone: (650) 556-9384<br>FAX: (650) 556-9385 |

### **Revision Information and Key Dates**

| <b>Revision Information and Key Dates</b>   |                   |
|---|-------------------|
| <b>SPC-1 Specification revision number</b>  | V1.9              |
| <b>SPC-1 Workload Generator revision number</b>   | V2.00.04a         |
| <b>Date Results were first used publicly</b>  | May 10, 2005      |
| <b>Date FDR was submitted to the SPC</b>  | May 10, 2005      |
| <b>Date revised FDR was submitted to the SPC</b><br>Revised Test Sponsor Name, product name, and primary/alternate contact information to reflect Sun/StorageTek merger | September 5, 2006 |
| <b>Revision History</b><br>June 3, 2005 – Revised pricing (Total Price and SPC-1 Price-Performance)   |                   |
| <b>Date the TSC is/was available for shipment to customers</b>  | May 16, 2005      |
| <b>Date the TSC completed audit certification</b>   | May 9, 2005       |

### Summary of Results

| SPC-1 Results  |                     |
|--|---------------------|
| Tested Storage Configuration (TSC) Name: Sun StorageTek® FlexLine™ FLX380 Storage System |                     |
| Metric   | Reported Result     |
| SPC-1 IOPS™  | 42,254.07           |
| SPC-1 Price-Performance  | \$14.03/SPC-1 IOPS™ |
| Total ASU Capacity   | 6,871.109GB         |
| Data Protection Level  | Mirroring           |
| Total TSC Price (including three-year maintenance)                                       | \$592,996           |

**SPC-1 IOPS™** represents the maximum I/O Request Throughput at the 100% load point.

**Total ASU (Application Storage Unit) Capacity** represents the total storage capacity read and written in the course of executing the SPC-1 benchmark.

A **Data Protection Level** of Mirroring configures two or more identical copies of user data.

### Storage Capacities and Relationships

The following diagram documents the various storage capacities, used in this benchmark, and their relationships.

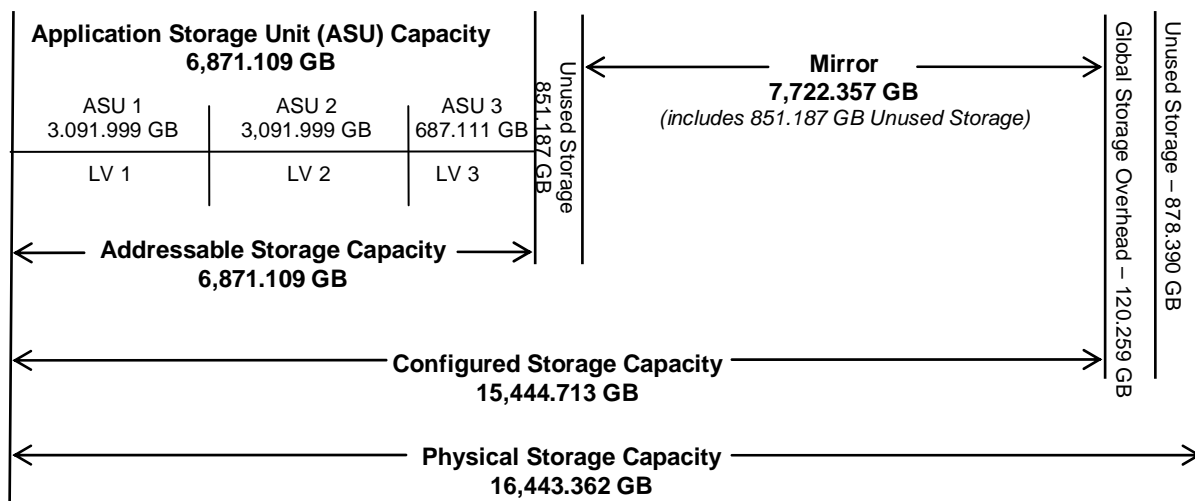

### Response Time – Throughput Curve

The Response Time-Throughput Curve illustrates the Average Response Time (milliseconds) and I/O Request Throughput at 100%, 95%, 90%, 80%, 50%, and 10% of the workload level used to generate the SPC-1 IOPS™ metric.

The Average Response Time measured at any of the above load points cannot exceed 30 milliseconds or the benchmark measurement is invalid.

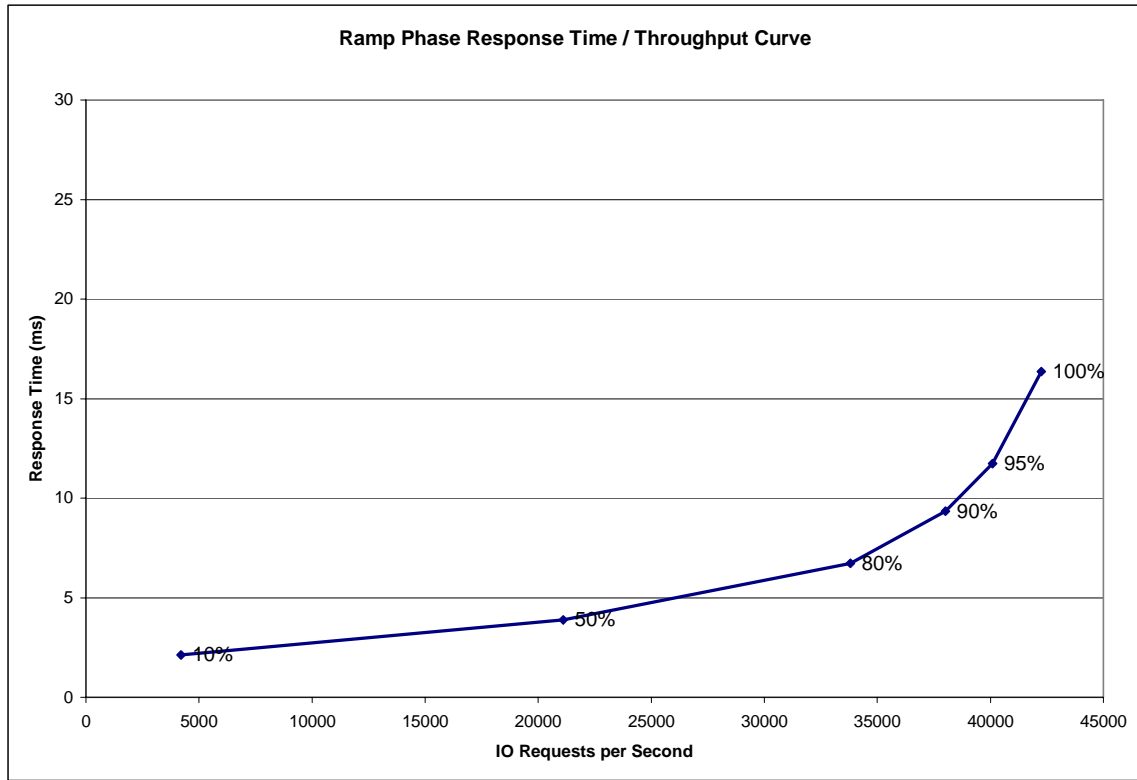

### Response Time – Throughput Data

|                                    | 10% Load | 50% Load  | 80% Load  | 90% Load  | 95% Load  | 100% Load |
|------------------------------------|----------|-----------|-----------|-----------|-----------|-----------|
| <b>I/O Request Throughput</b>      | 4,199.77 | 21,102.43 | 33,802.92 | 38,003.23 | 40,091.69 | 42,254.07 |
| <b>Average Response Time (ms):</b> |          |           |           |           |           |           |
| All ASUs                           | 2.12     | 3.88      | 6.74      | 9.34      | 11.75     | 16.36     |
| ASU-1                              | 2.76     | 4.89      | 7.86      | 10.31     | 12.50     | 16.69     |
| ASU-2                              | 2.75     | 5.45      | 9.83      | 13.34     | 16.29     | 21.94     |
| ASU-3                              | 0.50     | 1.05      | 2.99      | 5.53      | 8.16      | 13.23     |
| Reads                              | 4.70     | 8.34      | 12.63     | 15.36     | 17.47     | 21.46     |
| Writes                             | 0.45     | 0.97      | 2.90      | 5.42      | 8.02      | 13.05     |

### Tested Storage Configuration Pricing (*Priced Storage Configuration*)

| StorageTek Model No. | Description  | Unit Price | Qty | Aggregate Price |
|----------------------|--|------------|-----|-----------------|
| FLX3801              | FLX380 4Gb Enterprise controller   | \$ 80,000  | 1   | \$ 80,000       |
| FLSMGR1              | SANtricity Storage Manager v9.14 for Windows 2003                            | \$ 12,000  | 1   | \$ 12,000       |
| FLA3001              | FLA300 Access-Centric Switched array   | \$ 7,000   | 16  | \$ 112,000      |
| G73                  | 73 GB/15K Fibre Channel drive  | \$ 1,400   | 224 | \$ 313,600      |
| SNFCS75              | Brocade SilkWorm 4100 Switch, 16 Port, Includes 16 SFP                       | \$ 26,000  | 1   | \$ 26,000       |
| B4101                | Brocade SilkWorm 4100 Switch, 8 port Upgrade with 8 SFP                      | \$ 7,500   | 1   | \$ 7,500        |
| HBAQ003              | QLogic 2342 Host Bus Adapter   | \$ 2,900   | 8   | \$ 23,200       |
| 126544-01            | 25-meter fibre channel cables, optical, switch to controller, switch to host | \$ 145     | 24  | \$ 3,480        |
| FLX3801U             | Service Uplift for an additional 1 Year Elite 24/7                           | \$ 1,776   | 1   | \$ 1,776        |
| FLX3001U             | Service Uplift for an additional 1 Year Elite 24/7                           | \$ 684     | 16  | \$ 10,944       |
| SNFCS75U             | Service Uplift for an additional 1 Year Elite 24/7                           | \$ 2,496   | 1   | \$ 2,496        |
|                      |  |            |     | \$ 592,996      |

The above price for each component, with the exception of the QLogic Host Bus Adapters, includes a 2-year Elite warranty. In addition, a third year of Elite warranty is priced for those components. The Elite warranty provides maintenance/support 24 hours per day, 7 days per week for three years with four hour acknowledgement and four hour subsequent response (support engineer onsite or customer replaceable part available).

The price of each QLogic Host Bus Adapters (HBAQ003) includes a three year vendor warranty, which provides the required level of maintenance/support described above.

Pricing for the FLX380 Enterprise Controller and FLA300 Switched Arrays includes all required transceivers and cables.

### Differences between the Tested Storage Configuration (TSC) and Priced Storage Configuration

The Brocade SilkWorm 4100 switch used in the TSC was configured with 32 ports and 32 SFP transceivers. The benchmark measurement only used 24 ports and corresponding transceivers. The Brocade SilkWorm 4100 switch in the Priced Storage Configuration is configured with 24 ports and 24 SFP transceivers. If the TSC had used the switch configured with only 24 ports and transceivers, there would have not been any negative impact on the reported SPC-1 measurements.

**Benchmark Configuration/Tested Storage Configuration Diagram**

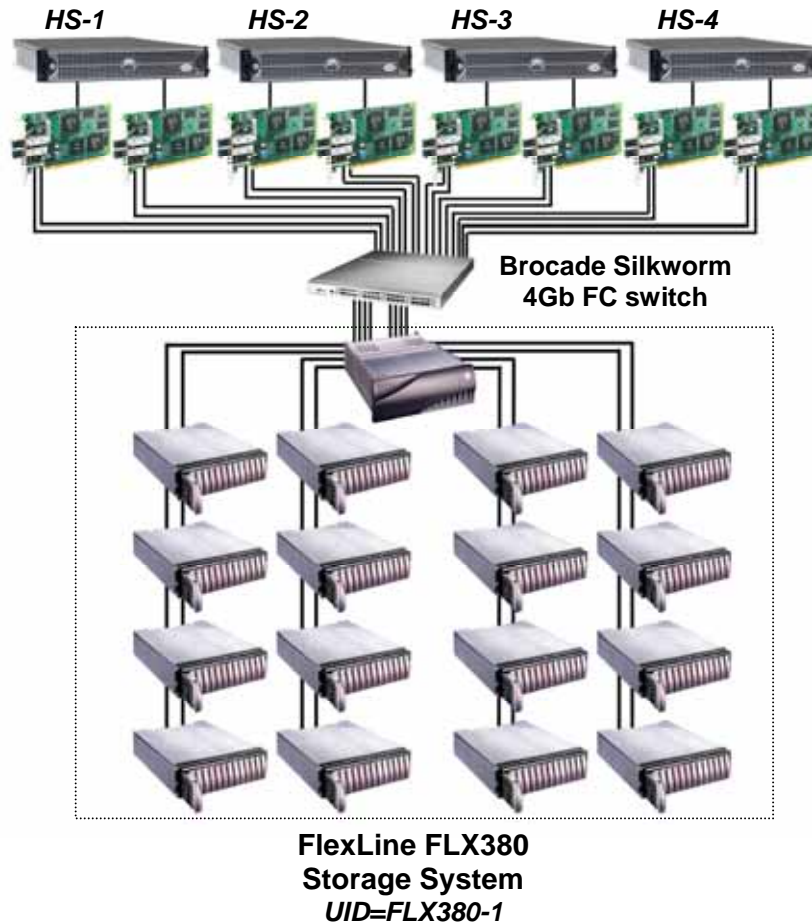

| Host Systems:  | Tested Storage Configuration (TSC)   |
|--|--|
| <b>UID=HS-1, HS-2, HS-3, HS-4:</b>   | SANtricity Storage Manager v9.   |
| 4 – Dell 2650 Servers, each configured with:<br>2 – 3.2 GHz Pentium 4 Xeon CPUs<br>512 KB L2 and 2 MB L3 caches/CPU<br>3 GB main memory<br>Windows 2003 Enterprise Edition | 8 – Qlogic 2342 HBAs (2 per Host System)   |
|  | 1 – Brocade SilkWorm 4100 switch   |
| WG   | <b>UID=FLX380-1:</b>   |
|  | StorageTek FlexLine FLX380 Storage System<br>1 – FLX380 4Gb Enterprise Controller<br>which includes:<br>2 – drive array controllers<br>2 GB of RAM per drive array controller<br>8 – 4 Gb Fibre Channel host connections<br>8 – 2 Gb Fibre Channel drive connections |
|  | 16 – FLA300 Access-Centric Switched array  |
|  | 224 – 73 GB 15K RPM Disk Drives  |

## **CONFIGURATION INFORMATION**

### **Benchmark Configuration (BC)/Tested Storage Configuration (TSC) Diagram**

#### *Clause 9.2.4.4.1*

*A one page Benchmark Configuration (BC)/Tested Storage Configuration (TSC) diagram shall be included in the Executive Summary...*

A diagram of the benchmark configuration and tested storage configuration is included on the preceding page. The configuration consists of four Host Systems, with two Qlogic 2342 PCI to dual-channel 2gb fibre channel host adapters each. The sixteen Host System, fibre channel connections, are connected to a Brocade Silkworm 4100 4gb fibre channel switch. The eight fibre channel host connections on the FLX380 4 Gb Enterprise Controller are also connected to the Brocade switch, and are running at 4gb. The Host Systems are running Windows 2003 Enterprise Edition. The Benchmark Configuration (BC)/Tested Storage Configuration (TSC) is illustrated on page 13 (*Benchmark Configuration/Tested Storage Configuration Diagram*).

### **Storage Network Configuration**

#### *Clause 9.2.4.4.1*

...

- 5. If the TSC contains network storage, the diagram will include the network configuration. If a single diagram is not sufficient to illustrate both the Benchmark Configuration and network configuration in sufficient detail, the Benchmark Configuration diagram will include a high-level network illustration as shown in Figure 9-8. In that case, a separate, detailed network configuration diagram will also be included as described in Clause 9.2.4.4.2.*

#### *Clause 9.2.4.4.2*

*If a storage network was configured as a part of the Tested Storage Configuration and the Benchmark Configuration diagram described in Clause 9.2.4.4.1 contains a high-level illustration of the network configuration, the Executive Summary will contain a one page topology diagram of the storage network as illustrated in Figure 9-9.*

The Benchmark Configuration (BC)/Tested Storage Configuration (TSC) was configured with local storage and, as such, did not employ a storage network.

## Host System Configuration

### Clause 9.2.4.4.3

The FDR shall minimally contain, for each Host System running the Workload Generator, a listing of the following:

1. Number and type of CPUs.
2. Main memory capacity.
3. Cache memory capacity.
4. Number and type of disk controllers or Host Bus Adapters.

SANtricity 9.14, Redundant Disk Array Controller (RDAC) package, was installed to support controller failover in the event of a host to disk array IO path failure. Other than installation, no additional configuration of this software was required.

The details of the Host System configuration may be found on page 13 (*Benchmark Configuration/Tested Storage Configuration Diagram*).

## Customer Tunable Parameters and Options

### Clause 9.2.4.5.1

All Benchmark Configuration (BC) components with customer tunable parameter and options that have been altered from their default values must be listed in the FDR. The FDR entry for each of those components must include both the name of the component and the altered value of the parameter or option. If the parameter name is not self-explanatory to a knowledgeable practitioner, a brief description of the parameter's use must also be included in the FDR entry.

“Appendix A: Customer Tunable Parameters and Options” on page 55 contains the customer tunable parameters and options that have been altered from their default values for this benchmark.

## Tested Storage Configuration (TSC) Description

### Clause 9.2.4.5.2

The FDR must include sufficient information to recreate the logical representation of the TSC. In addition to customer tunable parameters and options (Clause 4.2.4.5.3), that information must include, at a minimum:

- A diagram and/or description of the following:
  - All physical components that comprise the TSC. Those components are also illustrated in the BC Configuration Diagram in Clause 9.2.4.4.1 and/or the Storage Network Configuration Diagram in Clause 9.2.4.4.2.
  - The logical representation of the TSC, configured from the above components that will be presented to the Workload Generator.
- Listings of scripts used to create the logical representation of the TSC.
- If scripts were not used, a description of the process used with sufficient detail to recreate the logical representation of the TSC.

“Appendix B: Tested Storage Configuration (TSC) Creation” on page 57 contains the detailed information that describes how to create and configure the logical TSC.

## **SPC-1 Workload Generator Storage Configuration**

### Clause 9.2.4.5.3

*The FDR must include all SPC-1 Workload Generator storage configuration commands and parameters.*

The SPC-1 Workload Generator storage configuration commands and parameters for this measurement appear in “Appendix C: SPC-1 Workload Generator Storage Commands and Parameters” on page 61.



## **DATA REPOSITORY**

### **Definitions**

**Total ASU Capacity:** The total storage capacity read and written in the course of executing the SPC-1 benchmark.

**Application Storage Unit (ASU):** The logical interface between the storage and SPC-1 Workload Generator. The three ASUs (Data, User, and Log) are typically implemented on one or more Logical Volume.

**Logical Volume:** The division of Addressable Storage Capacity into individually addressable logical units of storage used in the SPC-1 benchmark. Each Logical Volume is implemented as a single, contiguous address space.

**Addressable Storage Capacity:** The total storage (sum of Logical Volumes) that can be read and written by application programs such as the SPC-1 Workload Generator.

**Configured Storage Capacity:** This capacity includes the Addressable Storage Capacity and any other storage (parity disks, hot spares, etc.) necessary to implement the Addressable Storage Capacity.

**Physical Storage Capacity:** The formatted capacity of all storage devices physically present in the Tested Storage Configuration (TSC).

**Data Protection Overhead:** The storage capacity required to implement the ECC data protection.

**Required Storage:** The amount of Configured Storage Capacity required to implement the Addressable Storage Configuration, excluding the storage required for the three ASUs.

**Global Storage Overhead:** The amount of Physical Storage Capacity that is required for storage subsystem use and unavailable for use by application programs.

**Total Unused Storage:** The amount of storage capacity available for use by application programs but not included in the Total ASU Capacity.

## Storage Capacities and Relationships

### Clause 9.2.4.6.1

Two tables and an illustration documenting the storage capacities and relationships of the SPC-1 Storage Hierarchy (Clause 2.1) shall be included in the FDR.

### SPC-1 Storage Capacities

| SPC-1 Storage Capacities          |                |            |
|-----------------------------------|----------------|------------|
| Storage Hierarchy Component       | Units          | Capacity   |
| Total ASU Capacity                | Gigabytes (GB) | 6,871.109  |
| Addressable Storage Capacity      | Gigabytes (GB) | 6,871.109  |
| Configured Storage Capacity       | Gigabytes (GB) | 15,444.713 |
| Physical Storage Capacity         | Gigabytes (GB) | 16,443.362 |
| Data Protection Overhead (mirror) | Gigabytes (GB) | 7,722.357  |
| Required Storage                  | Gigabytes (GB) | 0.000      |
| Global Storage Overhead           | Gigabytes (GB) | 120.259    |
| Total Unused Storage              | Gigabytes (GB) | 2,580.764  |

### SPC-1 Storage Hierarchy Ratios

|   | Addressable Storage Capacity | Configured Storage Capacity | Physical Storage Capacity |
|---|------------------------------|-----------------------------|---------------------------|
| <b>Total ASU Capacity</b>                       | 100.00%                      | 44.49%                      | 41.79%                    |
| <b>Required for Data Protection (Mirroring)</b> |                              | 50.00%                      | 46.96%                    |
| <b>Addressable Storage Capacity</b>             |                              | 44.49%                      | 41.79%                    |
| <b>Required Storage</b>                         |                              | 0.00%                       | 0.00%                     |
| <b>Configured Storage Capacity</b>              |                              |                             | 93.93%                    |
| <b>Global Storage Overhead</b>                  |                              |                             | 0.73%                     |
| <b>Unused Storage:</b>                          |                              |                             |                           |
| <b>Addressable</b>                              | 0.00%                        |                             |                           |
| <b>Configured</b>                               |                              | 11.02%                      |                           |
| <b>Physical</b>                                 |                              |                             | 5.34%                     |

The Physical Storage Capacity consisted of 16,443.262 GB distributed over 224 disk drives each with a formatted capacity of 73.408 GB. There was 878.39 GB (5.34%) of Unused Storage within the Physical Storage Capacity. Global Storage Overhead consisted of 120.259 GB (0.73%) of Physical Storage Capacity. There was 1,702.375 GB (11.02%) of Unused Storage within the Configured Storage Capacity. The Total ASU Capacity utilized 100% of the Addressable Storage Capacity resulting in 0.000 GB (0.00%) of Unused Storage within the Addressable Storage Capacity.

### SPC-1 Storage Capacities and Relationships Illustration

The various storage capacities configured in the benchmark result are illustrated below (not to scale).

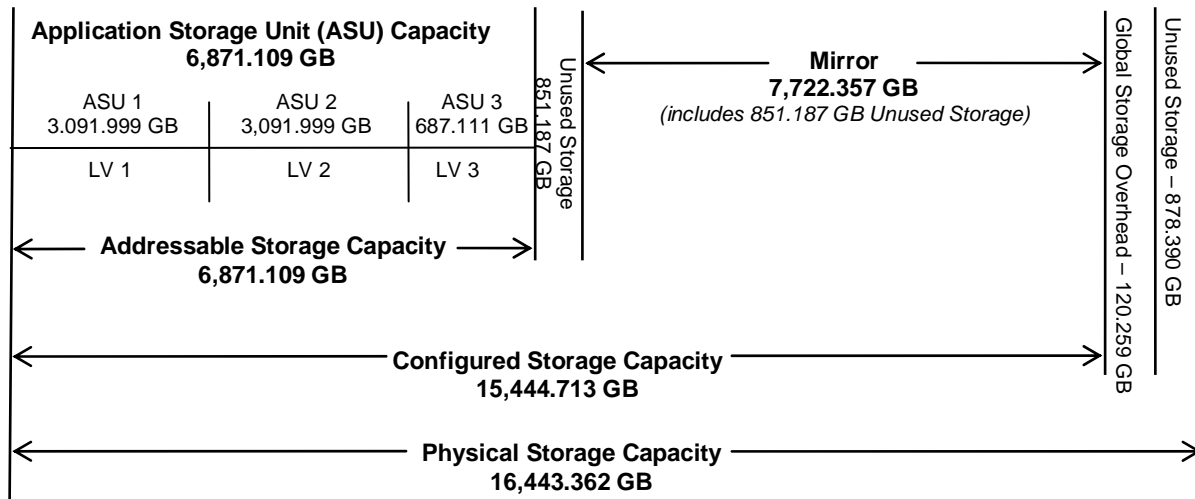

### Logical Volume Capacity and ASU Mapping

*Clause 9.2.4.6.2*

A table illustrating the capacity of each ASU and the mapping of Logical Volumes to ASUs shall be provided in the FDR. ... Logical Volumes shall be sequenced in the table from top to bottom per its position in the contiguous address space of each ASU. The capacity of each Logical Volume shall be stated. ... In conjunction with this table, the Test Sponsor shall provide a complete description of the type of data protection (see Clause 2.4.5) used on each Logical Volume.

| Logical Volume Capacity and Mapping  |   |   |
|--|---|---|
| ASU-1 (3,091.999 GB)   | ASU-2 (3,091.999 GB)  | ASU-3 (687.111 GB)  |
| 1 Logical Volume<br>3,091.999GB per Logical Volume<br>(3,091.999 GB used per Logical Volume) | 1 Logical Volume<br>3,091.999 GB per Logical Volume<br>(3,091.999 GB used per Logical Volume) | 1 Logical Volume<br>687.111 GB per Logical Volume<br>(687.111 GB used per Logical Volume) |

The Data Protection Level used for all Logical Volumes was Mirroring as described on page 10. See “ASU Configuration” in the [IOPS Test Results File](#) for more detailed configuration information.

## **SPC-1 BENCHMARK EXECUTION RESULTS**

### **Definitions**

**Average Response Time:** *The sum of the Response Times for all Measured I/O Requests divided by the total number of Measured I/O Requests.*

**I/O Request Throughput:** *The total number of Measured I/O requests in an SPC-1 Test Run divided by the duration of the Measurement Interval in seconds.*

**Measurement Interval:** *The finite and contiguous time period, after the Tested Storage Configuration (TSC) has reached Steady State, when data is collected by a Test Sponsor to generate an SPC-1 test result or support an SPC-1 test result.*

**Steady State:** *The consistent and sustainable throughput of the TSC. During this period the load presented to the TSC by the Workload Generator is constant. Comment: Steady Stated is achieved only after caches in the TSC have filled and as a result the I/O Request throughput of the TSC has stabilized.*

**Test:** *A collection of Test Phases or Test Runs sharing a common objective.*

**Test Phase:** *A collection of one or more SPC-1 Test Runs sharing a common objective and intended to be run in a specific sequence.*

**Test Run:** *The execution of SPC-1 for the purpose of producing or supporting an SPC-1 test result. SPC-1 Test Runs may have a finite and measured Ramp-Up period, Start-Up period, Shut-Down period, and Ramp-Down period as illustrated in the Figure 5-1 below. All SPC-1 Test Runs shall have a Steady State period and a Measurement Interval.*

The SPC-1 benchmark consists of the following Tests, Test Phases, and Test Runs:

- **Data Persistence Test**
  - Data Persistence Test Run 1
  - Data Persistence Test Run 2
- **Primary Metrics Test**
  - Sustainability Test Phase and Test Run
  - IOPS Test Phase and Test Run
  - Response Time Ramp Test Phase
    - 95% of IOPS Test Run
    - 90% of IOPS Test Run
    - 80% of IOPS Test Run
    - 50% of IOPS Test Run
    - 10% of IOPS Test Run (LRT)
- **Repeatability Test**
  - Repeatability Test Phase 1
    - 10% of IOPS Test Run (LRT)
    - IOPS Test Run
  - Repeatability Test Phase 2
    - 10% of IOPS Test Run (LRT)
    - IOPS Test Run

Each Test is an atomic unit that must be executed from start to finish before any other Test, Test Phase, or Test Run may be executed.

The results from each Test, Test Phase, and Test Run are listed below along with a more detailed explanation of each component.

## **Primary Metrics Test – Sustainability Test Phase**

### Clause 5.4.2.1

*The Sustainability Test Phase consists of one Test Run at the 100% load point with a Measurement Interval of three (3) hours. The intent is to demonstrate a sustained maximum I/O Request Throughput as well as insuring the Tested Storage Configuration (TSC) has reached steady state prior to measuring the maximum I/O Request Throughput (SPC-1™ IOPS).*

*The reported I/O Request Throughput of the Sustainability Test Run must be within 5% of the reported SPC-1™ IOPS primary metric. The Average Response Time measured in Sustainability Test Run cannot exceed thirty (30) milliseconds.*

### Clause 9.2.4.7.1

*For the Sustainability Test Phase the FDR shall contain:*

- 1. A Data Rate Distribution graph and data table.*
- 2. I/O Request Throughput Distribution graph and data table.*
- 3. A Response Time Frequency Distribution graph and table.*
- 4. An Average Response Time Distribution graph and table.*
- 5. The human readable Test Run Results File produced by the Workload Generator (may be included in an appendix).*
- 6. A listing or screen image of all input parameters supplied to the Workload Generator (may be included in an appendix).*
- 7. The Measured Intensity Multiplier for each I/O stream.*
- 8. The variability of the Measured Intensity Multiplier, as defined in Clause 5.3.13.3.*

## **SPC-1 Workload Generator Input Parameters**

The SPC-1 Workload Generator input parameters for the Sustainability, IOPS, and Response Time Ramp Test Runs are listed below.

`java -Xmx256m -Xms256m metrics -b 845 -s 300`

## **Sustainability Test Results File**

A link to the test results file generated from the Sustainability Test Run is listed below.

[Sustainability Test Results File](#)



### Sustainability – Data Rate Distribution Graph

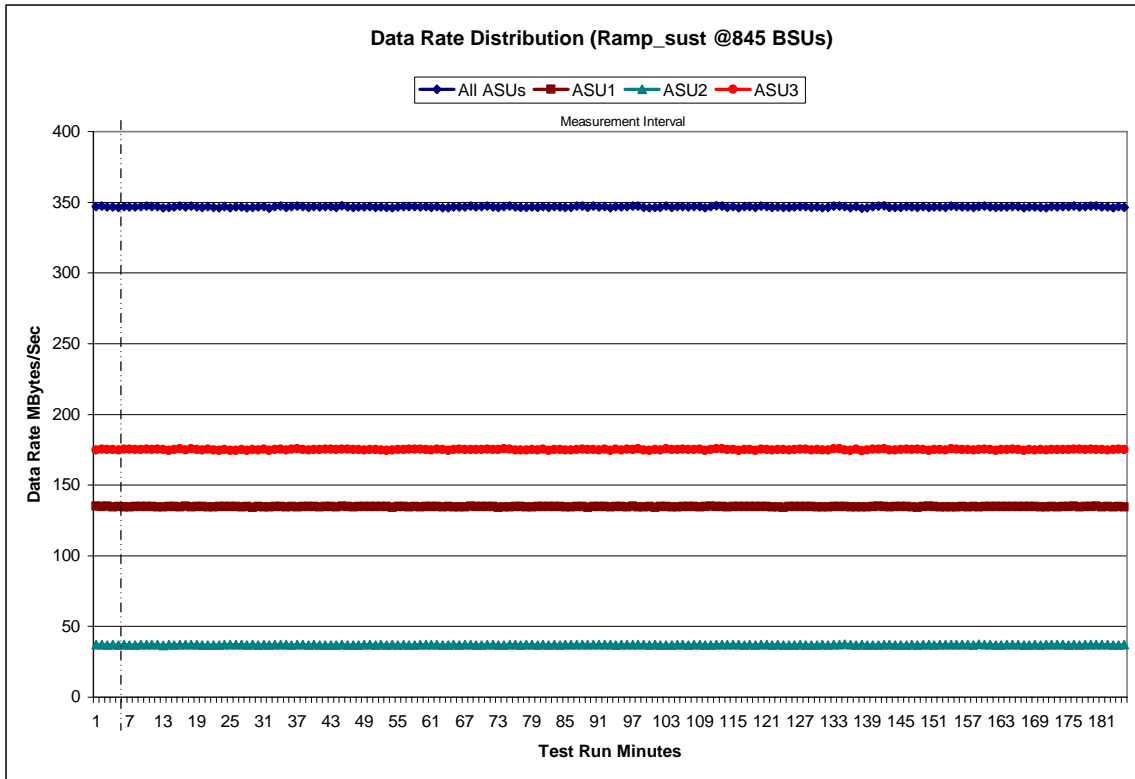





### Sustainability – I/O Request Throughput Distribution Graph

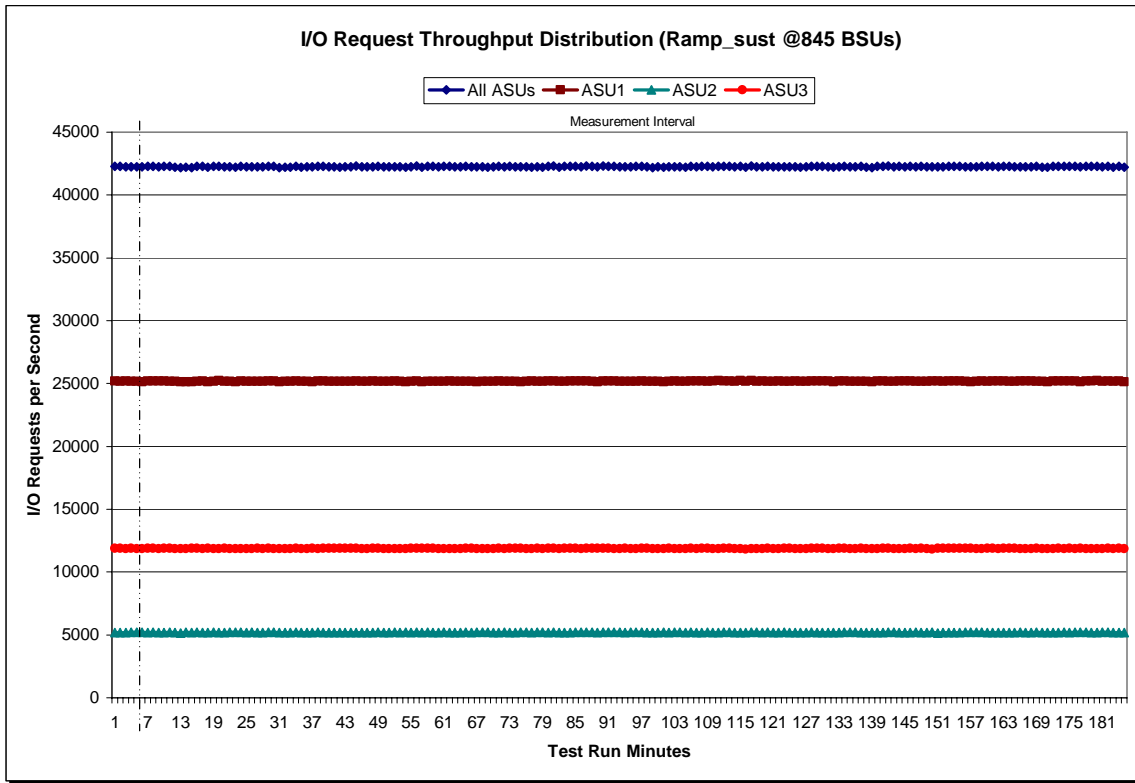

**Sustainability – Average Response Time (ms) Distribution Data**

| Ramp-Up/Start-Up     |          | Start    | Stop     | Interval | Duration |          |       |       |       |          |          |       |       |       |  |
|----------------------|----------|----------|----------|----------|----------|----------|-------|-------|-------|----------|----------|-------|-------|-------|--|
| Measurement Interval |          | 14:22:48 | 14:27:48 | 0-4      | 0:05:00  |          |       |       |       |          |          |       |       |       |  |
| Measurement Interval |          | 14:27:48 | 17:27:48 | 5-184    | 3:00:00  |          |       |       |       |          |          |       |       |       |  |
| Interval             | All ASUs | ASU1     | ASU2     | ASU3     | Interval | All ASUs | ASU1  | ASU2  | ASU3  | Interval | All ASUs | ASU1  | ASU2  | ASU3  |  |
| 0                    | 17.37    | 17.72    | 23.14    | 14.12    | 63       | 16.12    | 16.49 | 21.65 | 12.93 | 126      | 16.62    | 16.93 | 22.25 | 13.50 |  |
| 1                    | 16.51    | 16.83    | 22.15    | 13.37    | 64       | 16.20    | 16.55 | 21.81 | 13.01 | 127      | 16.50    | 16.81 | 22.13 | 13.38 |  |
| 2                    | 16.37    | 16.69    | 21.87    | 13.27    | 65       | 16.34    | 16.68 | 21.82 | 13.22 | 128      | 16.13    | 16.47 | 21.64 | 13.00 |  |
| 3                    | 16.49    | 16.80    | 22.10    | 13.38    | 66       | 16.22    | 16.57 | 21.71 | 13.08 | 129      | 16.45    | 16.79 | 21.98 | 13.33 |  |
| 4                    | 16.41    | 16.74    | 22.00    | 13.26    | 67       | 16.21    | 16.55 | 21.73 | 13.09 | 130      | 16.12    | 16.47 | 21.61 | 12.97 |  |
| 5                    | 16.35    | 16.66    | 21.89    | 13.25    | 68       | 16.37    | 16.70 | 21.87 | 13.26 | 131      | 16.42    | 16.74 | 22.04 | 13.29 |  |
| 6                    | 16.97    | 17.24    | 22.70    | 13.90    | 69       | 16.35    | 16.69 | 21.88 | 13.19 | 132      | 16.21    | 16.56 | 21.69 | 13.06 |  |
| 7                    | 16.21    | 16.55    | 21.73    | 13.09    | 70       | 16.64    | 16.94 | 22.24 | 13.56 | 133      | 16.35    | 16.68 | 21.88 | 13.22 |  |
| 8                    | 16.63    | 16.95    | 22.35    | 13.45    | 71       | 16.04    | 16.38 | 21.57 | 12.87 | 134      | 16.41    | 16.75 | 21.97 | 13.25 |  |
| 9                    | 16.33    | 16.65    | 21.85    | 13.24    | 72       | 16.37    | 16.70 | 21.89 | 13.25 | 135      | 16.20    | 16.56 | 21.71 | 13.01 |  |
| 10                   | 16.44    | 16.77    | 22.00    | 13.31    | 73       | 16.47    | 16.78 | 22.03 | 13.38 | 136      | 16.38    | 16.70 | 21.91 | 13.27 |  |
| 11                   | 16.58    | 16.89    | 22.17    | 13.48    | 74       | 16.37    | 16.70 | 21.87 | 13.25 | 137      | 16.05    | 16.41 | 21.53 | 12.88 |  |
| 12                   | 16.22    | 16.57    | 21.76    | 13.07    | 75       | 16.17    | 16.51 | 21.75 | 13.01 | 138      | 15.92    | 16.28 | 21.39 | 12.75 |  |
| 13                   | 16.18    | 16.53    | 21.71    | 13.01    | 76       | 15.85    | 16.22 | 21.26 | 12.70 | 139      | 16.33    | 16.67 | 21.93 | 13.17 |  |
| 14                   | 16.12    | 16.47    | 21.55    | 12.99    | 77       | 16.43    | 16.75 | 22.02 | 13.28 | 140      | 16.47    | 16.78 | 22.07 | 13.37 |  |
| 15                   | 16.38    | 16.70    | 21.90    | 13.30    | 78       | 16.28    | 16.66 | 21.82 | 13.04 | 141      | 16.47    | 16.79 | 22.05 | 13.35 |  |
| 16                   | 16.28    | 16.64    | 21.87    | 13.07    | 79       | 18.26    | 18.65 | 24.23 | 14.82 | 142      | 16.06    | 16.41 | 21.56 | 12.88 |  |
| 17                   | 16.15    | 16.50    | 21.70    | 12.98    | 80       | 16.73    | 17.05 | 22.40 | 13.58 | 143      | 16.13    | 16.50 | 21.62 | 12.95 |  |
| 18                   | 16.25    | 16.60    | 21.83    | 13.06    | 81       | 16.05    | 16.39 | 21.53 | 12.91 | 144      | 16.44    | 16.76 | 21.97 | 13.36 |  |
| 19                   | 16.61    | 16.91    | 22.26    | 13.52    | 82       | 16.27    | 16.63 | 21.82 | 13.10 | 145      | 16.60    | 16.91 | 22.14 | 13.52 |  |
| 20                   | 16.35    | 16.68    | 21.86    | 13.25    | 83       | 16.57    | 16.88 | 22.16 | 13.45 | 146      | 16.54    | 16.88 | 22.12 | 13.38 |  |
| 21                   | 16.31    | 16.64    | 21.88    | 13.18    | 84       | 16.34    | 16.69 | 21.87 | 13.18 | 147      | 16.28    | 16.61 | 21.83 | 13.16 |  |
| 22                   | 15.95    | 16.34    | 21.45    | 12.72    | 85       | 16.52    | 16.84 | 22.08 | 13.42 | 148      | 16.23    | 16.58 | 21.75 | 13.08 |  |
| 23                   | 16.35    | 16.67    | 21.85    | 13.24    | 86       | 16.17    | 16.52 | 21.65 | 13.03 | 149      | 15.84    | 16.23 | 21.26 | 12.64 |  |
| 24                   | 16.11    | 16.45    | 21.65    | 12.96    | 87       | 16.39    | 16.73 | 21.92 | 13.23 | 150      | 16.17    | 16.51 | 21.64 | 13.07 |  |
| 25                   | 16.09    | 16.44    | 21.66    | 12.90    | 88       | 16.42    | 16.75 | 21.97 | 13.30 | 151      | 16.75    | 17.07 | 22.39 | 13.62 |  |
| 26                   | 16.20    | 16.54    | 21.62    | 13.10    | 89       | 16.47    | 16.78 | 22.02 | 13.38 | 152      | 16.24    | 16.58 | 21.82 | 13.09 |  |
| 27                   | 16.33    | 16.67    | 21.81    | 13.19    | 90       | 16.36    | 16.70 | 21.94 | 13.19 | 153      | 16.41    | 16.73 | 21.99 | 13.29 |  |
| 28                   | 16.47    | 16.79    | 22.01    | 13.34    | 91       | 16.21    | 16.55 | 21.77 | 13.05 | 154      | 16.31    | 16.66 | 21.87 | 13.16 |  |
| 29                   | 16.66    | 16.98    | 22.26    | 13.53    | 92       | 16.23    | 16.59 | 21.75 | 13.05 | 155      | 16.19    | 16.52 | 21.70 | 13.06 |  |
| 30                   | 16.23    | 16.56    | 21.69    | 13.14    | 93       | 16.17    | 16.52 | 21.67 | 13.03 | 156      | 16.30    | 16.63 | 21.79 | 13.19 |  |
| 31                   | 15.89    | 16.25    | 21.35    | 12.72    | 94       | 16.07    | 16.41 | 21.51 | 12.95 | 157      | 16.06    | 16.43 | 21.54 | 12.89 |  |
| 32                   | 16.38    | 16.70    | 21.89    | 13.28    | 95       | 16.25    | 16.57 | 21.89 | 13.10 | 158      | 16.30    | 16.64 | 21.85 | 13.16 |  |
| 33                   | 16.36    | 16.68    | 21.90    | 13.25    | 96       | 16.58    | 16.90 | 22.15 | 13.49 | 159      | 16.54    | 16.85 | 22.17 | 13.43 |  |
| 34                   | 16.05    | 16.40    | 21.55    | 12.91    | 97       | 16.33    | 16.65 | 21.86 | 13.21 | 160      | 16.62    | 16.94 | 22.22 | 13.50 |  |
| 35                   | 16.48    | 16.79    | 22.02    | 13.39    | 98       | 16.11    | 16.46 | 21.52 | 12.99 | 161      | 16.07    | 16.42 | 21.54 | 12.93 |  |
| 36                   | 16.60    | 16.93    | 22.22    | 13.44    | 99       | 16.01    | 16.38 | 21.56 | 12.79 | 162      | 16.20    | 16.56 | 21.68 | 13.07 |  |
| 37                   | 16.43    | 16.74    | 21.98    | 13.32    | 100      | 16.10    | 16.45 | 21.65 | 12.92 | 163      | 16.45    | 16.78 | 22.06 | 13.32 |  |
| 38                   | 16.07    | 16.40    | 21.54    | 12.96    | 101      | 16.19    | 16.54 | 21.77 | 12.99 | 164      | 16.38    | 16.75 | 21.98 | 13.13 |  |
| 39                   | 16.41    | 16.73    | 22.00    | 13.29    | 102      | 16.27    | 16.61 | 21.76 | 13.14 | 165      | 17.04    | 17.39 | 22.84 | 13.75 |  |
| 40                   | 16.31    | 16.66    | 21.83    | 13.16    | 103      | 16.58    | 16.90 | 22.16 | 13.47 | 166      | 16.20    | 16.57 | 21.74 | 13.01 |  |
| 41                   | 16.36    | 16.68    | 21.97    | 13.23    | 104      | 16.37    | 16.73 | 21.84 | 13.21 | 167      | 16.45    | 16.78 | 21.95 | 13.33 |  |
| 42                   | 16.39    | 16.74    | 21.87    | 13.27    | 105      | 16.61    | 16.90 | 22.10 | 13.59 | 168      | 16.39    | 16.73 | 21.89 | 13.26 |  |
| 43                   | 16.62    | 17.04    | 22.25    | 13.27    | 106      | 16.42    | 16.74 | 21.95 | 13.31 | 169      | 16.08    | 16.44 | 21.51 | 12.93 |  |
| 44                   | 16.69    | 17.03    | 22.42    | 13.48    | 107      | 16.09    | 16.44 | 21.63 | 12.93 | 170      | 15.87    | 16.23 | 21.33 | 12.69 |  |
| 45                   | 16.39    | 16.71    | 22.01    | 13.24    | 108      | 16.73    | 17.03 | 22.37 | 13.62 | 171      | 16.24    | 16.58 | 21.78 | 13.12 |  |
| 46                   | 16.36    | 16.69    | 21.88    | 13.24    | 109      | 15.99    | 16.36 | 21.45 | 12.83 | 172      | 16.21    | 16.57 | 21.66 | 13.06 |  |
| 47                   | 16.32    | 16.65    | 21.86    | 13.20    | 110      | 16.37    | 16.69 | 21.93 | 13.25 | 173      | 16.42    | 16.74 | 21.97 | 13.30 |  |
| 48                   | 16.18    | 16.54    | 21.77    | 12.98    | 111      | 16.50    | 16.83 | 22.10 | 13.35 | 174      | 16.09    | 16.45 | 21.61 | 12.92 |  |
| 49                   | 15.97    | 16.35    | 21.41    | 12.79    | 112      | 16.55    | 16.87 | 22.17 | 13.43 | 175      | 16.29    | 16.63 | 21.82 | 13.15 |  |
| 50                   | 16.21    | 16.54    | 21.76    | 13.08    | 113      | 16.16    | 16.50 | 21.67 | 13.04 | 176      | 16.21    | 16.56 | 21.67 | 13.06 |  |
| 51                   | 16.12    | 16.45    | 21.58    | 13.01    | 114      | 16.32    | 16.66 | 21.89 | 13.17 | 177      | 16.40    | 16.71 | 21.94 | 13.31 |  |
| 52                   | 15.96    | 16.32    | 21.46    | 12.80    | 115      | 15.90    | 16.26 | 21.37 | 12.74 | 178      | 16.36    | 16.68 | 21.96 | 13.23 |  |
| 53                   | 16.01    | 16.38    | 21.45    | 12.85    | 116      | 16.33    | 16.67 | 21.85 | 13.19 | 179      | 16.13    | 16.48 | 21.55 | 13.01 |  |
| 54                   | 16.39    | 16.72    | 21.83    | 13.30    | 117      | 16.38    | 16.72 | 21.87 | 13.25 | 180      | 16.06    | 16.41 | 21.62 | 12.89 |  |
| 55                   | 16.56    | 16.88    | 22.19    | 13.42    | 118      | 16.09    | 16.44 | 21.57 | 12.95 | 181      | 16.62    | 16.94 | 22.29 | 13.46 |  |
| 56                   | 16.18    | 16.53    | 21.69    | 13.04    | 119      | 16.32    | 16.65 | 21.92 | 13.16 | 182      | 16.29    | 16.61 | 21.82 | 13.22 |  |
| 57                   | 16.35    | 16.68    | 21.92    | 13.22    | 120      | 16.22    | 16.58 | 21.66 | 13.07 | 183      | 16.17    | 16.51 | 21.62 | 13.07 |  |
| 58                   | 16.29    | 16.63    | 21.84    | 13.16    | 121      | 16.69    | 17.07 | 22.39 | 13.39 | 184      | 16.12    | 16.47 | 21.57 | 12.98 |  |
| 59                   | 16.11    | 16.47    | 21.61    | 12.95    | 122      | 16.60    | 16.94 | 22.29 | 13.39 | Average  | 16.32    | 16.66 | 21.86 | 13.18 |  |
| 60                   | 16.31    | 16.66    | 21.83    | 13.16    | 123      | 16.18    | 16.52 | 21.67 | 13.06 |          |          |       |       |       |  |
| 61                   | 16.33    | 16.64    | 21.88    | 13.25    | 124      | 16.55    | 16.86 | 22.09 | 13.47 |          |          |       |       |       |  |
| 62                   | 16.17    | 16.51    | 21.65    | 13.04    | 125      | 16.24    | 16.58 | 21.68 | 13.15 |          |          |       |       |       |  |

### Sustainability – Average Response Time (ms) Distribution Graph

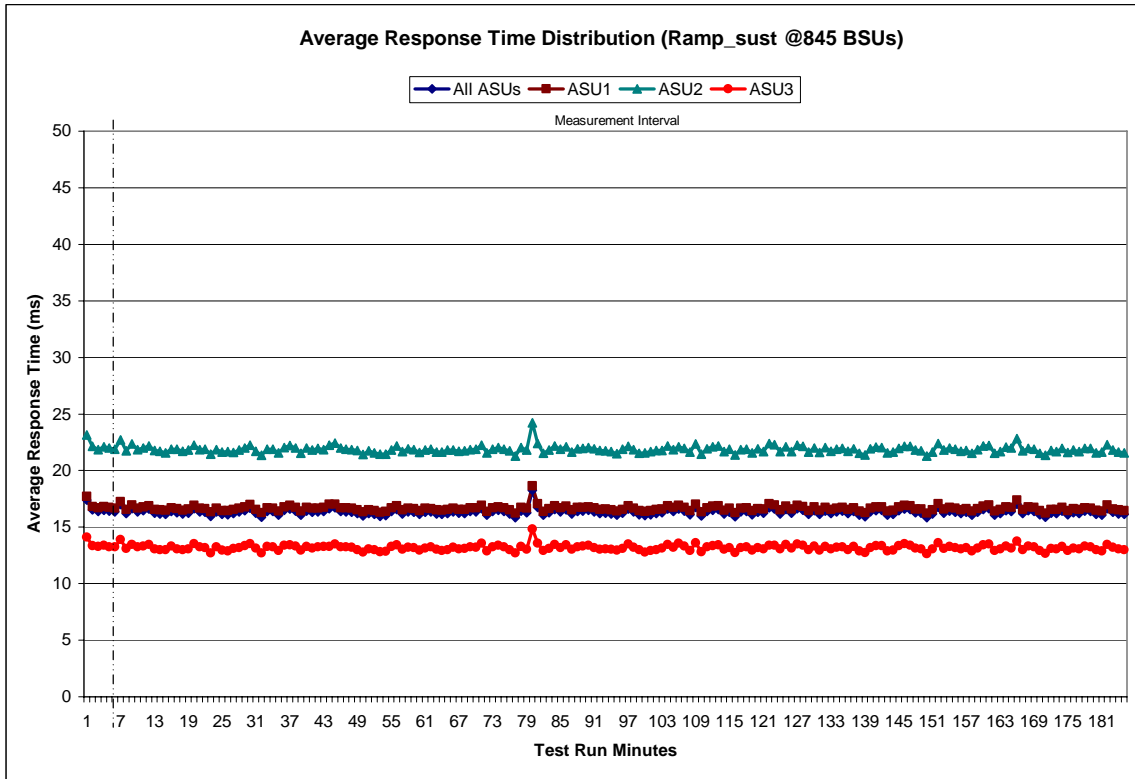

**Sustainability – Response Time Frequency Distribution Data**

| Response Time (ms) | 0-0.25     | >0.25-0.5  | >0.5-0.75  | >0.75-1.0   | >1.0-1.25  | >1.25-1.5  | >1.5-1.75  | >1.75-2.0  |
|--------------------|------------|------------|------------|-------------|------------|------------|------------|------------|
| Read               | 13388      | 246,919    | 272,203    | 200,985     | 188,090    | 157,716    | 119,378    | 85,536     |
| Write              | 0          | 115        | 1,159      | 4,103       | 12,779     | 29,851     | 55,495     | 73,384     |
| All ASUs           | 13388      | 247,034    | 273,362    | 205,088     | 200,869    | 187,567    | 174,873    | 158,920    |
| ASU1               | 12564      | 231,105    | 254,999    | 189,453     | 180,888    | 160,583    | 136,582    | 113,724    |
| ASU2               | 824        | 15,895     | 17,986     | 14,200      | 15,052     | 15,125     | 15,892     | 15,145     |
| ASU3               | 0          | 34         | 377        | 1,435       | 4,929      | 11,859     | 22,399     | 30,051     |
| Response Time (ms) | >2.0-2.5   | >2.5-3.0   | >3.0-3.5   | >3.5-4.0    | >4.0-4.5   | >4.5-5.0   | >5.0-6.0   | >6.0-7.0   |
| Read               | 222,052    | 192,576    | 280,276    | 328,228     | 640,729    | 792,401    | 2,643,831  | 4,583,899  |
| Write              | 434,332    | 715,664    | 1,396,579  | 1,750,023   | 3,387,070  | 3,721,839  | 10,451,219 | 15,408,238 |
| All ASUs           | 656,384    | 908,240    | 1,676,855  | 2,078,251   | 4,027,799  | 4,514,240  | 13,095,050 | 19,992,137 |
| ASU1               | 409,634    | 513,781    | 912,879    | 1,115,919   | 2,161,136  | 2,443,367  | 7,191,080  | 11,135,038 |
| ASU2               | 65,838     | 92,628     | 170,656    | 208,305     | 401,162    | 443,733    | 1,286,148  | 1,988,151  |
| ASU3               | 180,912    | 301,831    | 593,320    | 754,027     | 1,465,501  | 1,627,140  | 4,617,822  | 6,868,948  |
| Response Time (ms) | >7.0-8.0   | >8.0-9.0   | >9.0-10.0  | >10.0-15.0  | >15.0-20.0 | >20.0-25.0 | >25.0-30.0 | >30.0      |
| Read               | 5,914,692  | 7,704,126  | 8,161,200  | 44,784,619  | 33,797,652 | 21,357,968 | 13,666,520 | 33,629,412 |
| Write              | 17,432,593 | 21,178,375 | 21,023,818 | 97,794,179  | 52,260,174 | 19,706,534 | 6,019,684  | 3,496,321  |
| All ASUs           | 23,347,285 | 28,882,501 | 29,185,018 | 142,578,798 | 86,057,826 | 41,064,502 | 19,686,204 | 37,125,733 |
| ASU1               | 13,134,822 | 16,328,344 | 16,555,619 | 82,121,927  | 51,514,254 | 26,388,173 | 13,787,453 | 24,990,836 |
| ASU2               | 2,360,157  | 2,963,319  | 3,027,042  | 14,986,609  | 9,540,894  | 5,097,285  | 2,962,719  | 10,422,090 |
| ASU3               | 7,852,306  | 9,590,838  | 9,602,357  | 45,470,262  | 25,002,678 | 9,579,044  | 2,936,032  | 1,712,807  |

**Sustainability – Response Time Frequency Distribution Graph**

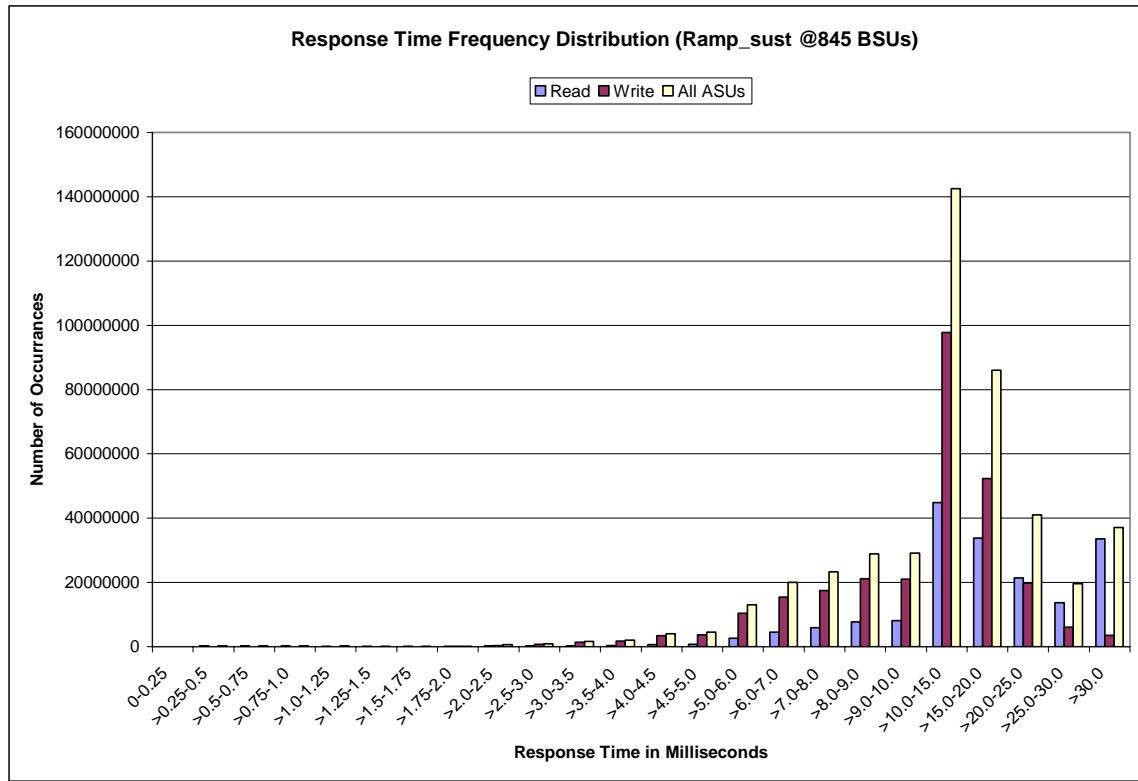

**Sustainability – Measured Intensity Multiplier and Coefficient of Variation**

|     | ASU1-1 | ASU1-2 | ASU1-3 | ASU1-4 | ASU2-1 | ASU2-2 | ASU2-3 | ASU3-1 |
|-----|--------|--------|--------|--------|--------|--------|--------|--------|
| IM  | 0.0350 | 0.2810 | 0.0700 | 0.2100 | 0.0180 | 0.0700 | 0.0350 | 0.2810 |
| MIM | 0.0350 | 0.2810 | 0.0700 | 0.2100 | 0.0180 | 0.0700 | 0.0350 | 0.2810 |
| COV | 0.004  | 0.001  | 0.002  | 0.001  | 0.004  | 0.003  | 0.003  | 0.001  |

Clause 3.4.3

**IM – Intensity Multiplier:** The ratio of I/Os for each I/O stream relative to the total I/Os for all I/O streams (ASU1-1 – ASU3-1) as required by the benchmark specification.

Clauses 5.1.0 and 5.3.13.2

**MIM – Measured Intensity Multiplier:** The Measured Intensity Multiplier represents the ratio of measured I/Os for each I/O stream relative to the total I/Os measured for all I/O streams (ASU1-1 – ASU3-1). This value may differ from the corresponding Expected Intensity Multiplier by no more than 5%.

Clause 5.3.13.3

**COV – Coefficient of Variation:** This measure of variation for the Measured Intensity Multiplier cannot exceed 0.2.

## Primary Metrics Test – IOPS Test Phase

### Clause 5.4.4.2

*The IOPS Test Phase consists of one Test Run at the 100% load point with a Measurement Interval of ten (10) minutes. The IOPS Test Phase immediately follows the Sustainability Test Phase without any interruption or manual intervention.*

*The IOPS Test Run generates the SPC-1 IOPS™ primary metric, which is computed as the I/O Request Throughput for the Measurement Interval of the IOPS Test Run.*

*The Average Response Time is computed for the IOPS Test Run and cannot exceed 30 milliseconds. If the Average Response Time exceeds the 30 millisecond constraint, the measurement is invalid.*

### Clause 9.2.4.7.2

*For the IOPS Test Phase the FDR shall contain:*

- 1. I/O Request Throughput Distribution graph and table.*
- 2. A Response Time Frequency Distribution graph and table.*
- 3. An Average Response Time Distribution graph and table.*
- 4. The human readable Test Run Results File produced by the Workload Generator.*
- 5. A listing or screen image of all input parameters supplied to the Workload Generator.*
- 6. The total number of I/O Requests completed in the Measurement Interval as well as the number of I/O Requests with a Response Time less than or equal to 30 milliseconds and the number of I/O Requests with a Response Time greater than 30 milliseconds.*

## SPC-1 Workload Generator Input Parameters

The SPC-1 Workload Generator input parameters for the Sustainability, IOPS, and Response Time Ramp Test Runs are listed below.

```
java -Xmx256m -Xms256m metrics -b 845 -s 300
```

## IOPS Test Results File

A link to the test results file generated from the IOPS Test Run is listed below.

[IOPS Test Results File](#)

**IOPS Test Run – I/O Request Throughput Distribution Data**

| 845 BSUs                    |           |           |          |           |
|-----------------------------|-----------|-----------|----------|-----------|
|                             | Start     | Stop      | Interval | Duration  |
| <i>Start-Up/Ramp-Up</i>     | 17:28:10  | 17:33:11  | 0-4      | 0:05:01   |
| <i>Measurement Interval</i> | 17:33:11  | 17:43:11  | 5-14     | 0:10:00   |
| 60 second intervals         | All ASUs  | ASU1      | ASU2     | ASU3      |
| 0                           | 42,236.43 | 25,200.50 | 5,189.47 | 11,846.47 |
| 1                           | 42,258.13 | 25,177.70 | 5,201.17 | 11,879.27 |
| 2                           | 42,198.58 | 25,171.52 | 5,193.45 | 11,833.62 |
| 3                           | 42,215.47 | 25,174.78 | 5,188.65 | 11,852.03 |
| 4                           | 42,278.58 | 25,182.28 | 5,208.03 | 11,888.27 |
| 5                           | 42,241.83 | 25,190.90 | 5,198.25 | 11,852.68 |
| 6                           | 42,237.38 | 25,169.63 | 5,188.07 | 11,879.68 |
| 7                           | 42,282.78 | 25,214.03 | 5,208.52 | 11,860.23 |
| 8                           | 42,278.03 | 25,200.03 | 5,201.02 | 11,876.98 |
| 9                           | 42,223.32 | 25,148.77 | 5,209.00 | 11,865.55 |
| 10                          | 42,219.23 | 25,173.02 | 5,189.30 | 11,856.92 |
| 11                          | 42,260.78 | 25,159.70 | 5,191.35 | 11,909.73 |
| 12                          | 42,285.35 | 25,212.53 | 5,188.78 | 11,884.03 |
| 13                          | 42,242.62 | 25,175.75 | 5,186.07 | 11,880.80 |
| 14                          | 42,269.33 | 25,171.48 | 5,205.75 | 11,892.10 |
| <b>Average</b>              | 42,254.07 | 25,181.59 | 5,196.61 | 11,875.87 |

**IOPS Test Run – I/O Request Throughput Distribution Graph**

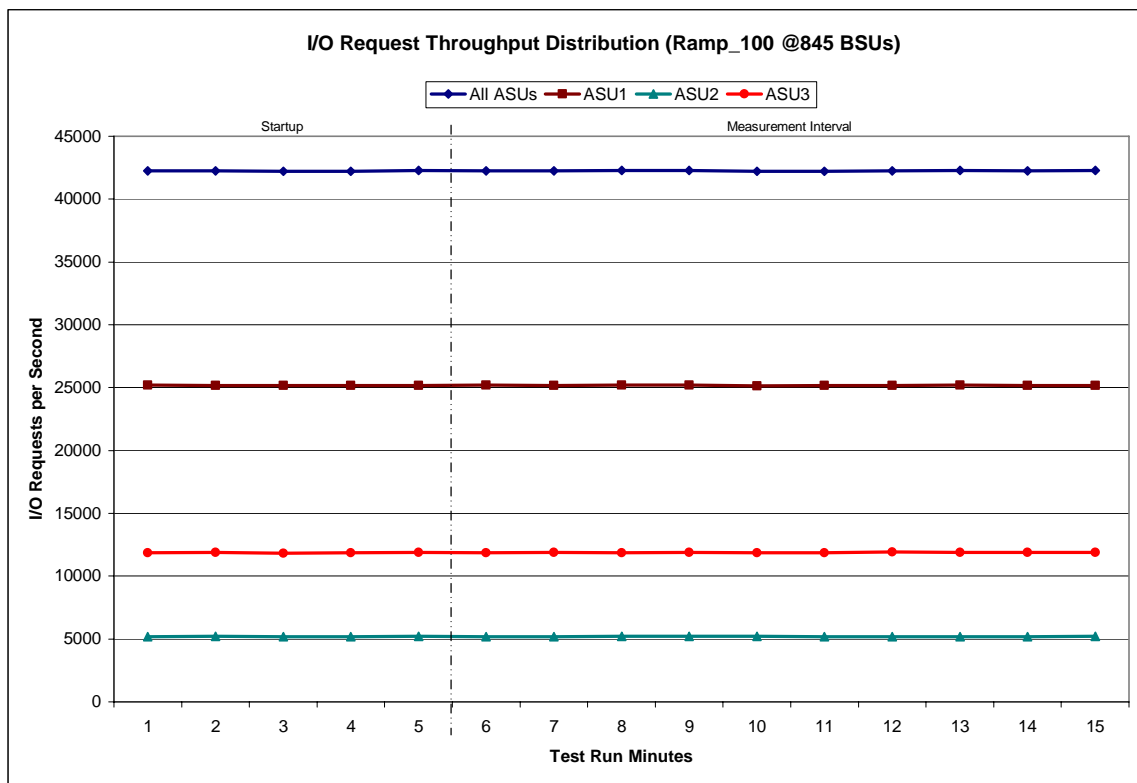

**IOPS Test Run – Response Time Frequency Distribution Data**

| Response Time (ms) | 0-0.25 | >0.25-0.5 | >0.5-0.75 | >0.75-1.0 | >1.0-1.25 | >1.25-1.5 | >1.5-1.75 | >1.75-2.0 |
|--------------------|--------|-----------|-----------|-----------|-----------|-----------|-----------|-----------|
| Read               | 839    | 14,768    | 16,537    | 12,176    | 11,208    | 9,365     | 7,190     | 5,182     |
| Write              | 0      | 4         | 39        | 146       | 570       | 1,378     | 2,699     | 3,752     |
| All ASUs           | 839    | 14,772    | 16,576    | 12,322    | 11,778    | 10,743    | 9,889     | 8,934     |
| ASU1               | 798    | 13,943    | 15,532    | 11,485    | 10,693    | 9,369     | 7,979     | 6,607     |
| ASU2               | 41     | 829       | 1,035     | 787       | 863       | 815       | 814       | 791       |
| ASU3               | 0      | -         | 9         | 50        | 222       | 559       | 1,096     | 1,536     |

  

| Response Time (ms) | >2.0-2.5 | >2.5-3.0 | >3.0-3.5 | >3.5-4.0 | >4.0-4.5 | >4.5-5.0 | >5.0-6.0 | >6.0-7.0  |
|--------------------|----------|----------|----------|----------|----------|----------|----------|-----------|
| Read               | 13,237   | 11,033   | 15,889   | 18,277   | 35,696   | 43,455   | 146,443  | 252,210   |
| Write              | 22,960   | 39,107   | 77,969   | 98,577   | 191,650  | 207,993  | 576,160  | 850,067   |
| All ASUs           | 36,197   | 50,140   | 93,858   | 116,854  | 227,346  | 251,448  | 722,603  | 1,102,277 |
| ASU1               | 23,157   | 28,783   | 51,507   | 62,628   | 121,750  | 135,893  | 397,328  | 613,805   |
| ASU2               | 3,508    | 5,006    | 9,481    | 11,781   | 22,583   | 24,472   | 70,942   | 109,282   |
| ASU3               | 9,532    | 16,351   | 32,870   | 42,445   | 83,013   | 91,083   | 254,333  | 379,190   |

| Response Time (ms) | >7.0-8.0  | >8.0-9.0  | >9.0-10.0 | >10.0-15.0 | >15.0-20.0 | >20.0-25.0 | >25.0-30.0 | >30.0     |
|--------------------|-----------|-----------|-----------|------------|------------|------------|------------|-----------|
| Read               | 325,108   | 424,973   | 450,325   | 2,475,281  | 1,876,168  | 1,189,523  | 762,571    | 1,878,981 |
| Write              | 966,513   | 1,172,977 | 1,165,841 | 5,399,038  | 2,909,541  | 1,111,807  | 350,182    | 206,320   |
| All ASUs           | 1,291,621 | 1,597,950 | 1,616,166 | 7,874,319  | 4,785,709  | 2,301,330  | 1,112,753  | 2,085,301 |
| ASU1               | 725,857   | 902,418   | 915,986   | 4,536,888  | 2,863,673  | 1,476,186  | 775,244    | 1,400,999 |
| ASU2               | 130,400   | 163,994   | 167,712   | 826,748    | 530,873    | 285,484    | 166,350    | 583,263   |
| ASU3               | 435,364   | 531,538   | 532,468   | 2,510,683  | 1,391,163  | 539,660    | 171,159    | 101,039   |

**IOPS Test Run –Response Time Frequency Distribution Graph**



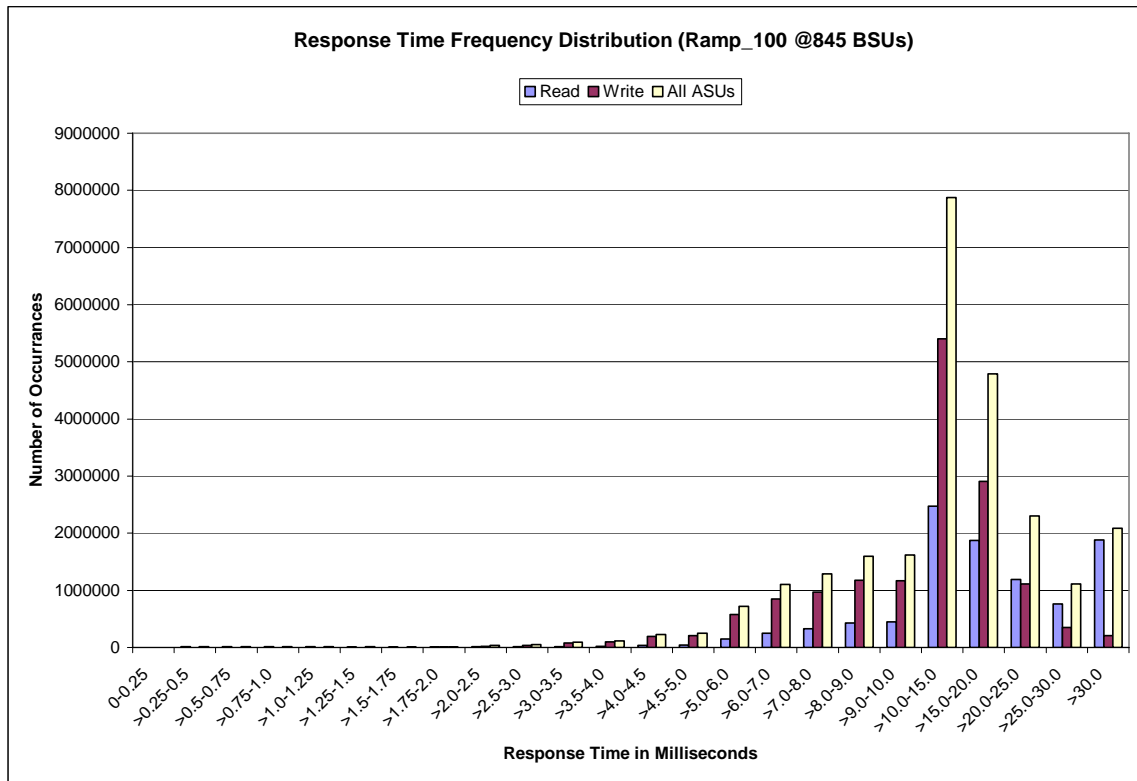

**IOPS Test Run – Average Response Time (ms) Distribution Data**

| 845 BSUs                    | Start    | Stop     | Interval | Duration |
|-----------------------------|----------|----------|----------|----------|
| <i>Start-Up/Ramp-Up</i>     | 17:28:10 | 17:33:11 | 0-4      | 0:05:01  |
| <i>Measurement Interval</i> | 17:33:11 | 17:43:11 | 5-14     | 0:10:00  |
| 60 second intervals         | All ASUs | ASU1     | ASU2     | ASU3     |
| 0                           | 16.65    | 16.95    | 21.99    | 13.66    |
| 1                           | 16.23    | 16.56    | 21.75    | 13.12    |
| 2                           | 16.14    | 16.48    | 21.72    | 12.96    |
| 3                           | 16.08    | 16.43    | 21.62    | 12.91    |
| 4                           | 16.38    | 16.71    | 21.92    | 13.25    |
| 5                           | 16.23    | 16.57    | 21.76    | 13.07    |
| 6                           | 16.22    | 16.57    | 21.73    | 13.07    |
| 7                           | 16.54    | 16.85    | 22.19    | 13.42    |
| 8                           | 16.61    | 16.90    | 22.24    | 13.51    |
| 9                           | 16.19    | 16.53    | 21.72    | 13.05    |
| 10                          | 16.03    | 16.38    | 21.58    | 12.84    |
| 11                          | 16.41    | 16.72    | 21.99    | 13.31    |
| 12                          | 16.57    | 16.89    | 22.17    | 13.44    |
| 13                          | 16.59    | 16.88    | 22.20    | 13.51    |
| 14                          | 16.26    | 16.62    | 21.83    | 13.07    |
| <b>Average</b>              | 16.36    | 16.69    | 21.94    | 13.23    |

**IOPS Test Run – Average Response Time (ms) Distribution Graph**

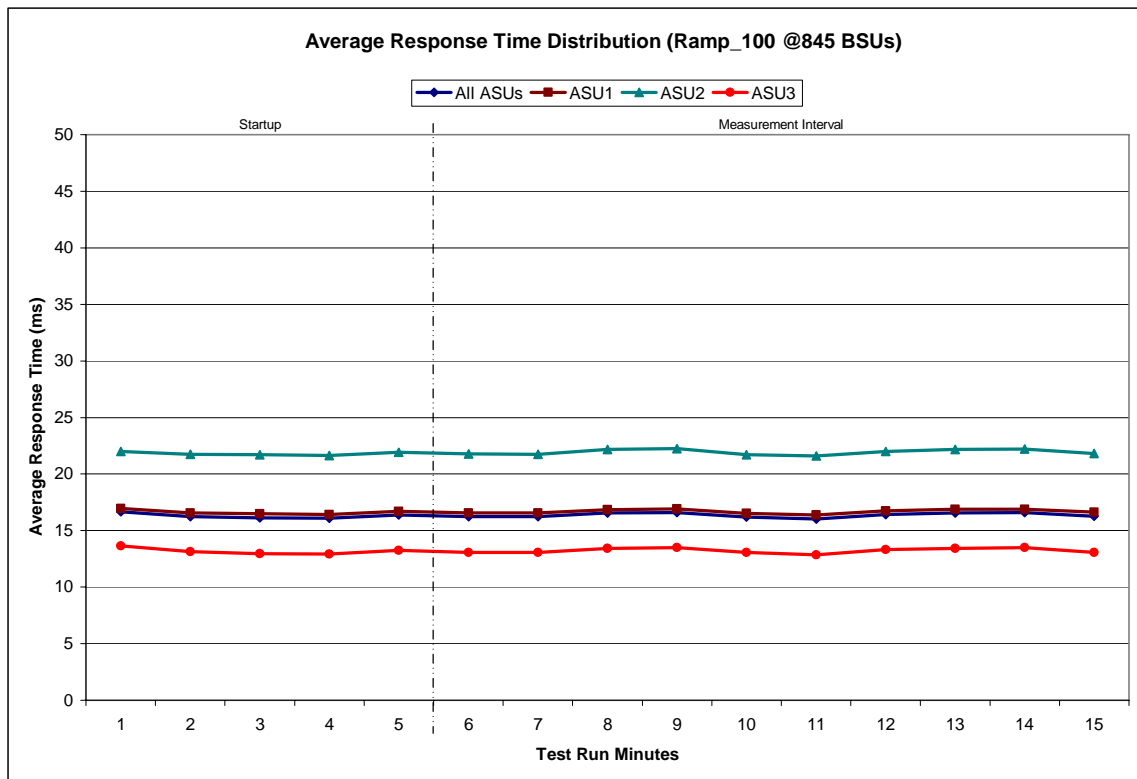

**IOPS Test Run – I/O Request Information**

| I/O Requests Completed in the Measurement Interval | I/O Requests Completed with Response Time = or < 30 ms | I/O Requests Completed with Response Time > 30 ms |
|--|--|---|
| 25,351,725   | 23,266,424   | 2,085,301   |

**IOPS Test Run – Measured Intensity Multiplier and Coefficient of Variation**

|     | ASU1-1 | ASU1-2 | ASU1-3 | ASU1-4 | ASU2-1 | ASU2-2 | ASU2-3 | ASU3-1 |
|-----|--------|--------|--------|--------|--------|--------|--------|--------|
| IM  | 0.0350 | 0.2810 | 0.0700 | 0.2100 | 0.0180 | 0.0700 | 0.0350 | 0.2810 |
| MIM | 0.0350 | 0.2809 | 0.0701 | 0.2100 | 0.0180 | 0.0700 | 0.0350 | 0.2811 |
| COV | 0.003  | 0.001  | 0.001  | 0.001  | 0.005  | 0.003  | 0.002  | 0.001  |

Clause 3.4.3

**IM – Intensity Multiplier:** The ratio of I/Os for each I/O stream relative to the total I/Os for all I/O streams (ASU1-1 – ASU3-1) as required by the benchmark specification.

Clauses 5.1.0 and 5.3.13.2

**MIM – Measured Intensity Multiplier:** The Measured Intensity Multiplier represents the ratio of measured I/Os for each I/O stream relative to the total I/Os measured for all I/O streams (ASU1-1 – ASU3-1). This value may differ from the corresponding Expected Intensity Multiplier by no more than 5%.

Clause 5.3.13.3

**COV – Coefficient of Variation:** This measure of variation for the Measured Intensity Multiplier cannot exceed 0.2.

## Primary Metrics Test – Response Time Ramp Test Phase

### Clause 5.4.4.3

The Response Time Ramp Test Phase consists of five Test Runs, one each at 95%, 90%, 80%, 50%, and 10% of the load point (100%) used to generate the SPC-1 IOPS™ primary metric. Each of the five Test Runs has a Measurement Interval of ten (10) minutes. The Response Time Ramp Test Phase immediately follows the IOPS Test Phase without any interruption or manual intervention.

The five Response Time Ramp Test Runs, in conjunction with the IOPS Test Run (100%), demonstrate the relationship between Average Response Time and I/O Request Throughput for the Tested Storage Configuration (TSC) as illustrated in the response time/throughput curve on page 11.

In addition, the Average Response Time measured during the 10% Test Run is the value for the SPC-1 LRT™ metric. That value represents the Average Response Time of a lightly loaded TSC.

### Clause 9.2.4.7.3

The following content shall appear in the FDR for the Response Time Ramp Phase:

1. A Response Time Ramp Distribution graph.
2. The human readable Test Run Results File produced by the Workload Generator for each Test Run within the Response Time Ramp Test Phase.
3. For the 10% Load Level Test Run (SPC-1 LRT™ metric) an Average Response Time Distribution graph and table.
4. A listing or screen image of all input parameters supplied to the Workload Generator.

## SPC-1 Workload Generator Input Parameters

The SPC-1 Workload Generator input parameters for the Sustainability, IOPS, and Response Time Ramp Test Runs are listed below.

```
java -Xmx256m -Xms256m metrics -b 845 -s 300
```

## Response Time Ramp Test Results File

A link to each test result file generated from each Response Time Ramp Test Run list listed below.

[95% Load Level](#)

[90% Load Level](#)

[80% Load Level](#)

[50% Load Level](#)

[10% Load Level](#)

**Response Time Ramp Distribution (IOPS) Data**

The five Test Runs that comprise the Response Time Ramp Phase are executed at 95%, 90%, 80%, 50%, and 10% of the Business Scaling Unit (BSU) load level used to produce the SPC-1 IOPS™ primary metric. The 100% BSU load level is included in the following Response Time Ramp data tables and graphs for completeness.

| 100% Load Level - 845 BSUs   |           |           |          |           | 95% Load Level - 802 BSUs    |           |           |          |           |
|------------------------------|-----------|-----------|----------|-----------|------------------------------|-----------|-----------|----------|-----------|
| Start                        | Stop      | Interval  | Duration |           | Start                        | Stop      | Interval  | Duration |           |
| 17:28:10                     | 17:33:11  | 0-4       | 0:05:01  |           | 17:43:30                     | 17:48:31  | 0-4       | 0:05:01  |           |
| 17:33:11                     | 17:43:11  | 5-14      | 0:10:00  |           | 17:48:31                     | 17:58:31  | 5-14      | 0:10:00  |           |
| <i>(60 second intervals)</i> |           |           |          |           | <i>(60 second intervals)</i> |           |           |          |           |
| All ASUs                     | ASU-1     | ASU-2     | ASU-3    |           | All ASUs                     | ASU-1     | ASU-2     | ASU-3    |           |
| 0                            | 42,236.43 | 25,200.50 | 5,189.47 | 11,846.47 | 0                            | 40,111.92 | 23,874.58 | 4,943.18 | 11,294.15 |
| 1                            | 42,258.13 | 25,177.70 | 5,201.17 | 11,879.27 | 1                            | 40,097.77 | 23,913.58 | 4,910.28 | 11,273.90 |
| 2                            | 42,198.58 | 25,171.52 | 5,193.45 | 11,833.62 | 2                            | 40,111.52 | 23,897.45 | 4,930.15 | 11,283.92 |
| 3                            | 42,215.47 | 25,174.78 | 5,188.65 | 11,852.03 | 3                            | 40,045.75 | 23,864.63 | 4,931.67 | 11,249.45 |
| 4                            | 42,278.58 | 25,182.28 | 5,208.03 | 11,888.27 | 4                            | 40,100.77 | 23,908.70 | 4,928.60 | 11,263.47 |
| 5                            | 42,241.83 | 25,190.90 | 5,198.25 | 11,852.68 | 5                            | 40,085.65 | 23,899.43 | 4,936.57 | 11,249.65 |
| 6                            | 42,237.38 | 25,169.63 | 5,188.07 | 11,879.68 | 6                            | 40,102.83 | 23,882.38 | 4,946.42 | 11,274.03 |
| 7                            | 42,282.78 | 25,214.03 | 5,208.52 | 11,860.23 | 7                            | 40,155.90 | 23,939.17 | 4,944.82 | 11,271.92 |
| 8                            | 42,278.03 | 25,200.03 | 5,201.02 | 11,876.98 | 8                            | 40,048.32 | 23,865.18 | 4,922.97 | 11,260.17 |
| 9                            | 42,223.32 | 25,148.77 | 5,209.00 | 11,865.55 | 9                            | 40,067.95 | 23,880.60 | 4,927.25 | 11,260.10 |
| 10                           | 42,219.23 | 25,173.02 | 5,189.30 | 11,856.92 | 10                           | 40,099.37 | 23,897.15 | 4,928.07 | 11,274.15 |
| 11                           | 42,260.78 | 25,159.70 | 5,191.35 | 11,909.73 | 11                           | 40,073.67 | 23,883.92 | 4,927.77 | 11,261.98 |
| 12                           | 42,285.35 | 25,212.53 | 5,188.78 | 11,884.03 | 12                           | 40,093.98 | 23,875.93 | 4,942.08 | 11,275.97 |
| 13                           | 42,242.62 | 25,175.75 | 5,186.07 | 11,880.80 | 13                           | 40,099.60 | 23,896.58 | 4,940.35 | 11,262.67 |
| 14                           | 42,269.33 | 25,171.48 | 5,205.75 | 11,892.10 | 14                           | 40,089.58 | 23,860.92 | 4,938.80 | 11,289.87 |
| Average                      | 42,254.07 | 25,181.59 | 5,196.61 | 11,875.87 | Average                      | 40,091.69 | 23,888.13 | 4,935.51 | 11,268.05 |
| 90% Load Level - 760 BSUs    |           |           |          |           | 80% Load Level - 676 BSUs    |           |           |          |           |
| Start                        | Stop      | Interval  | Duration |           | Start                        | Stop      | Interval  | Duration |           |
| 17:58:49                     | 18:03:50  | 0-4       | 0:05:01  |           | 18:14:08                     | 18:19:09  | 0-4       | 0:05:01  |           |
| 18:03:50                     | 18:13:50  | 5-14      | 0:10:00  |           | 18:19:09                     | 18:29:09  | 5-14      | 0:10:00  |           |
| <i>(60 second intervals)</i> |           |           |          |           | <i>(60 second intervals)</i> |           |           |          |           |
| All ASUs                     | ASU-1     | ASU-2     | ASU-3    |           | All ASUs                     | ASU-1     | ASU-2     | ASU-3    |           |
| 0                            | 38,021.38 | 22,620.80 | 4,678.62 | 10,721.97 | 0                            | 33,777.48 | 20,124.17 | 4,153.27 | 9,500.05  |
| 1                            | 38,028.32 | 22,676.62 | 4,671.40 | 10,680.30 | 1                            | 33,858.85 | 20,199.42 | 4,169.22 | 9,490.22  |
| 2                            | 37,962.05 | 22,618.18 | 4,665.17 | 10,678.70 | 2                            | 33,790.92 | 20,150.43 | 4,157.82 | 9,482.67  |
| 3                            | 37,962.55 | 22,634.43 | 4,680.50 | 10,647.62 | 3                            | 33,788.55 | 20,126.62 | 4,154.63 | 9,507.30  |
| 4                            | 37,995.40 | 22,654.50 | 4,680.28 | 10,660.62 | 4                            | 33,786.50 | 20,135.62 | 4,158.37 | 9,492.52  |
| 5                            | 37,965.92 | 22,621.33 | 4,677.87 | 10,666.72 | 5                            | 33,773.25 | 20,133.72 | 4,143.48 | 9,496.05  |
| 6                            | 37,963.18 | 22,616.27 | 4,673.68 | 10,673.23 | 6                            | 33,811.73 | 20,168.53 | 4,151.60 | 9,491.60  |
| 7                            | 38,004.98 | 22,662.43 | 4,668.92 | 10,673.63 | 7                            | 33,791.47 | 20,142.93 | 4,154.33 | 9,494.20  |
| 8                            | 38,008.33 | 22,663.18 | 4,680.35 | 10,664.80 | 8                            | 33,856.78 | 20,179.12 | 4,159.13 | 9,518.53  |
| 9                            | 38,012.28 | 22,656.62 | 4,679.48 | 10,676.18 | 9                            | 33,767.48 | 20,143.93 | 4,149.87 | 9,473.68  |
| 10                           | 37,972.35 | 22,634.78 | 4,666.75 | 10,670.82 | 10                           | 33,792.58 | 20,156.18 | 4,136.08 | 9,500.32  |
| 11                           | 38,023.27 | 22,659.82 | 4,663.78 | 10,699.67 | 11                           | 33,819.33 | 20,161.25 | 4,140.32 | 9,517.77  |
| 12                           | 38,014.38 | 22,651.48 | 4,677.60 | 10,685.30 | 12                           | 33,820.58 | 20,173.70 | 4,153.72 | 9,493.17  |
| 13                           | 38,040.83 | 22,657.88 | 4,691.70 | 10,691.25 | 13                           | 33,802.03 | 20,146.47 | 4,168.15 | 9,487.42  |
| 14                           | 38,026.80 | 22,644.95 | 4,683.08 | 10,698.77 | 14                           | 33,793.92 | 20,161.38 | 4,148.30 | 9,484.23  |
| Average                      | 38,003.23 | 22,646.88 | 4,676.32 | 10,680.04 | Average                      | 33,802.92 | 20,156.72 | 4,150.50 | 9,495.70  |
| 50% Load Level - 422 BSUs    |           |           |          |           | 10% Load Level - 84 BSUs     |           |           |          |           |
| Start                        | Stop      | Interval  | Duration |           | Start                        | Stop      | Interval  | Duration |           |
| 18:29:26                     | 18:34:27  | 0-4       | 0:05:01  |           | 18:44:44                     | 18:49:45  | 0-4       | 0:05:01  |           |
| 18:34:27                     | 18:44:27  | 5-14      | 0:10:00  |           | 18:49:45                     | 18:59:45  | 5-14      | 0:10:00  |           |
| <i>(60 second intervals)</i> |           |           |          |           | <i>(60 second intervals)</i> |           |           |          |           |
| All ASUs                     | ASU-1     | ASU-2     | ASU-3    |           | All ASUs                     | ASU-1     | ASU-2     | ASU-3    |           |
| 0                            | 21,104.75 | 12,581.00 | 2,603.72 | 5,920.03  | 0                            | 4,209.40  | 2,509.63  | 516.88   | 1,182.88  |
| 1                            | 21,065.98 | 12,555.22 | 2,584.65 | 5,926.12  | 1                            | 4,201.83  | 2,506.30  | 517.73   | 1,177.80  |
| 2                            | 21,136.22 | 12,603.65 | 2,597.60 | 5,934.97  | 2                            | 4,214.50  | 2,517.85  | 513.52   | 1,183.13  |
| 3                            | 21,120.42 | 12,584.22 | 2,600.53 | 5,935.67  | 3                            | 4,216.18  | 2,521.22  | 517.17   | 1,177.80  |
| 4                            | 21,115.27 | 12,579.87 | 2,596.50 | 5,938.90  | 4                            | 4,202.58  | 2,507.35  | 513.45   | 1,181.78  |
| 5                            | 21,092.15 | 12,563.18 | 2,599.25 | 5,929.72  | 5                            | 4,189.88  | 2,498.27  | 516.40   | 1,175.22  |
| 6                            | 21,075.17 | 12,566.52 | 2,584.52 | 5,924.13  | 6                            | 4,199.53  | 2,507.97  | 513.82   | 1,177.75  |
| 7                            | 21,100.72 | 12,587.02 | 2,584.70 | 5,929.00  | 7                            | 4,202.27  | 2,503.13  | 519.25   | 1,179.88  |
| 8                            | 21,099.15 | 12,568.08 | 2,592.40 | 5,938.67  | 8                            | 4,211.68  | 2,507.38  | 518.13   | 1,186.17  |
| 9                            | 21,101.28 | 12,588.42 | 2,594.95 | 5,917.92  | 9                            | 4,193.30  | 2,496.02  | 517.10   | 1,180.18  |
| 10                           | 21,107.77 | 12,584.92 | 2,587.88 | 5,934.97  | 10                           | 4,199.15  | 2,499.65  | 518.05   | 1,181.45  |
| 11                           | 21,122.93 | 12,590.22 | 2,598.42 | 5,934.30  | 11                           | 4,205.87  | 2,507.97  | 519.82   | 1,178.08  |
| 12                           | 21,091.37 | 12,589.52 | 2,586.70 | 5,915.15  | 12                           | 4,201.12  | 2,502.02  | 516.00   | 1,183.10  |
| 13                           | 21,106.15 | 12,576.27 | 2,597.52 | 5,932.37  | 13                           | 4,193.92  | 2,507.05  | 516.55   | 1,170.32  |
| 14                           | 21,127.65 | 12,584.17 | 2,597.65 | 5,945.83  | 14                           | 4,200.98  | 2,502.73  | 514.13   | 1,184.12  |
| Average                      | 21,102.43 | 12,579.83 | 2,592.40 | 5,930.21  | Average                      | 4,199.77  | 2,503.22  | 516.93   | 1,179.63  |

### Response Time Ramp Distribution (IOPS) Graph

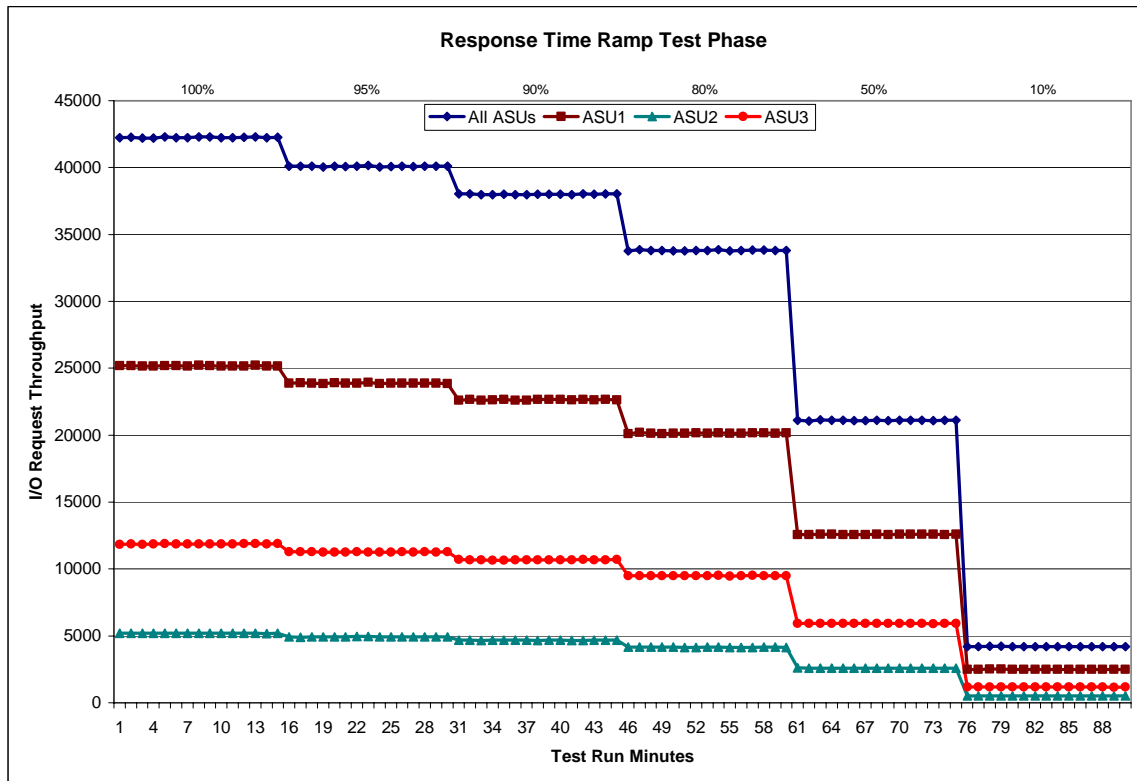

**SPC-1 LRT™ Average Response Time (ms) Distribution Data**

| 84 BSUs                     | Start    | Stop     | Interval | Duration |
|-----------------------------|----------|----------|----------|----------|
| <i>Start-Up/Ramp-Up</i>     | 18:44:44 | 18:49:45 | 0-4      | 0:05:01  |
| <i>Measurement Interval</i> | 18:49:45 | 18:59:45 | 5-14     | 0:10:00  |
| 60 second intervals         | All ASUs | ASU1     | ASU2     | ASU3     |
| 0                           | 2.06     | 2.69     | 2.62     | 0.48     |
| 1                           | 2.12     | 2.75     | 2.74     | 0.50     |
| 2                           | 2.12     | 2.75     | 2.75     | 0.50     |
| 3                           | 2.12     | 2.75     | 2.73     | 0.50     |
| 4                           | 2.12     | 2.76     | 2.74     | 0.50     |
| 5                           | 2.12     | 2.75     | 2.74     | 0.50     |
| 6                           | 2.12     | 2.76     | 2.72     | 0.50     |
| 7                           | 2.12     | 2.75     | 2.75     | 0.50     |
| 8                           | 2.12     | 2.76     | 2.76     | 0.51     |
| 9                           | 2.13     | 2.77     | 2.75     | 0.50     |
| 10                          | 2.12     | 2.75     | 2.75     | 0.50     |
| 11                          | 2.13     | 2.76     | 2.73     | 0.51     |
| 12                          | 2.12     | 2.75     | 2.79     | 0.50     |
| 13                          | 2.13     | 2.76     | 2.74     | 0.50     |
| 14                          | 2.12     | 2.75     | 2.75     | 0.50     |
| <b>Average</b>              | 2.12     | 2.76     | 2.75     | 0.50     |

**SPC-1 LRT™ Average Response Time (ms) Distribution Graph**

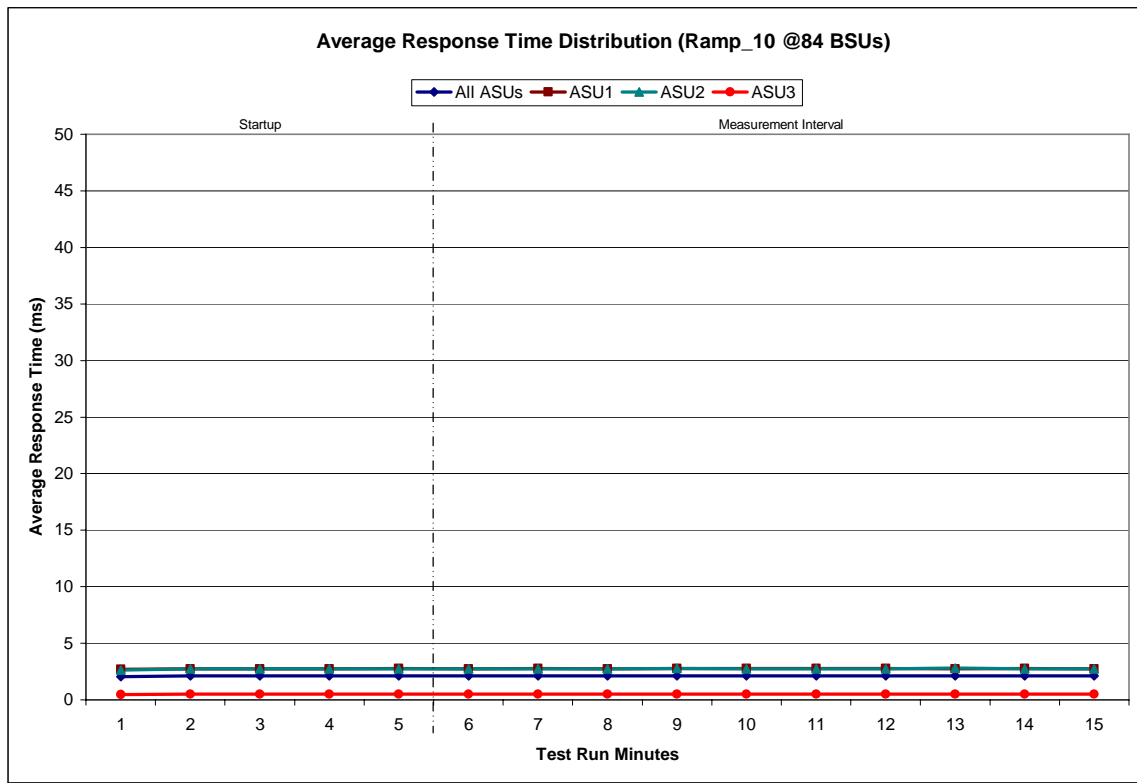

**SPC-1 LRT™ (10%) – Measured Intensity Multiplier and Coefficient of Variation**

|     | ASU1-1 | ASU1-2 | ASU1-3 | ASU1-4 | ASU2-1 | ASU2-2 | ASU2-3 | ASU3-1 |
|-----|--------|--------|--------|--------|--------|--------|--------|--------|
| IM  | 0.0350 | 0.2810 | 0.0700 | 0.2100 | 0.0180 | 0.0700 | 0.0350 | 0.2810 |
| MIM | 0.0350 | 0.2813 | 0.0699 | 0.2099 | 0.0180 | 0.0701 | 0.0350 | 0.2809 |
| COV | 0.012  | 0.004  | 0.007  | 0.004  | 0.009  | 0.006  | 0.009  | 0.003  |

Clause 3.4.3

**IM – Intensity Multiplier:** The ratio of I/Os for each I/O stream relative to the total I/Os for all I/O streams (ASU1-1 – ASU3-1) as required by the benchmark specification.

Clauses 5.1.0 and 5.3.13.2

**MIM – Measured Intensity Multiplier:** The Measured Intensity Multiplier represents the ratio of measured I/Os for each I/O stream relative to the total I/Os measured for all I/O streams (ASU1-1 – ASU3-1). This value may differ from the corresponding Expected Intensity Multiplier by no more than 5%.

Clause 5.3.13.3

**COV – Coefficient of Variation:** This measure of variation for the Measured Intensity Multiplier cannot exceed 0.2.

## Repeatability Test

### Clause 5.4.5

*The Repeatability Test demonstrates the repeatability and reproducibility of the SPC-1 IOPS™ primary metric and SPC-1 LRT™ metric generated in earlier Test Runs.*

*There are two identical Repeatability Test Phases. Each Test Phase contains two Test Runs. Each of the Test Runs will have a Measurement Interval of no less than ten (10) minutes. The two Test Runs in each Test Phase will be executed without interruption or any type of manual intervention.*

*The first Test Run in each Test Phase is executed at the 10% load point. The Average Response Time from each of the Test Runs is compared to the SPC-1 LRT™ metric. Each Average Response Time value must be less than the SPC-1 LRT™ metric plus 5%.*

*The second Test Run in each Test Phase is executed at the 100% load point. The I/O Request Throughput from the Test Runs is compared to the SPC-1 IOPS™ primary metric. Each I/O Request Throughput value must be greater than the SPC-1 IOPS™ primary metric minus 5%. In addition, the Average Response Time for each Test Run cannot exceed 30 milliseconds.*

*If any of the above constraints are not met, the benchmark measurement is invalid.*

### Clause 9.2.4.7.4

*The following content shall appear in the FDR for each Test Run in the two Repeatability Test Phases:*

- 1. A table containing the results of the Repeatability Test.*
- 2. An I/O Request Throughput Distribution graph and table.*
- 3. An Average Response Time Distribution graph and table.*
- 4. The human readable Test Run Results File produced by the Workload Generator.*
- 5. A listing or screen image of all input parameters supplied to the Workload Generator.*

## SPC-1 Workload Generator Input Parameters

The SPC-1 Workload Generator input parameters for the Repeatability Test Runs are listed below.

`java -Xmx256m -Xms256m repeat1 -b 845 -s 300`

`java -Xmx256m -Xms256m repeat2 -b 845 -s 300`



### Repeatability Test Results File

The values for the SPC-1 IOPS™, SPC-1 LRT™, and the Repeatability Test measurements are listed below.

|                            | SPC-1 IOPS™ | SPC-1 LRT™ |
|----------------------------|-------------|------------|
| <i>Primary Metrics</i>     | 42,254.07   | 2.12       |
| Repeatability Test Phase 1 | 42,249.90   | 2.14       |
| Repeatability Test Phase 2 | 42,247.81   | 2.15       |

A link to the test result file generated from each Repeatability Test Run list is listed below.

[Repeatability Test Phase 1, Test Run 1 \(LRT\)](#)

[Repeatability Test Phase 1, Test Run 2 \(IOPS\)](#)

[Repeatability Test Phase 2, Test Run 1 \(LRT\)](#)

[Repeatability Test Phase 2, Test Run 2 \(IOPS\)](#)

**Repeatability 1 LRT - I/O Request Throughput Distribution Data**

| 84 BSUs                     | Start    | Stop     | Interval | Duration |
|-----------------------------|----------|----------|----------|----------|
| <i>Start-Up/Ramp-Up</i>     | 19:00:07 | 19:05:07 | 0-4      | 0:05:00  |
| <i>Measurement Interval</i> | 19:05:07 | 19:15:07 | 5-14     | 0:10:00  |
| 60 second intervals         | All ASUs | ASU1     | ASU2     | ASU3     |
| 0                           | 4,187.38 | 2,490.92 | 520.53   | 1,175.93 |
| 1                           | 4,209.83 | 2,505.28 | 519.25   | 1,185.30 |
| 2                           | 4,215.43 | 2,517.28 | 522.40   | 1,175.75 |
| 3                           | 4,212.68 | 2,508.73 | 519.30   | 1,184.65 |
| 4                           | 4,213.15 | 2,510.20 | 518.37   | 1,184.58 |
| 5                           | 4,212.40 | 2,508.07 | 516.63   | 1,187.70 |
| 6                           | 4,210.82 | 2,507.77 | 520.45   | 1,182.60 |
| 7                           | 4,209.75 | 2,506.40 | 516.22   | 1,187.13 |
| 8                           | 4,202.78 | 2,497.87 | 514.55   | 1,190.37 |
| 9                           | 4,198.33 | 2,500.30 | 515.48   | 1,182.55 |
| 10                          | 4,197.00 | 2,505.97 | 515.38   | 1,175.65 |
| 11                          | 4,204.27 | 2,507.78 | 518.43   | 1,178.05 |
| 12                          | 4,209.85 | 2,514.48 | 519.65   | 1,175.72 |
| 13                          | 4,200.00 | 2,503.45 | 516.25   | 1,180.30 |
| 14                          | 4,207.47 | 2,507.23 | 517.75   | 1,182.48 |
| <b>Average</b>              | 4,205.27 | 2,505.93 | 517.08   | 1,182.26 |

**Repeatability 1 LRT - I/O Request Throughput Distribution Graph**

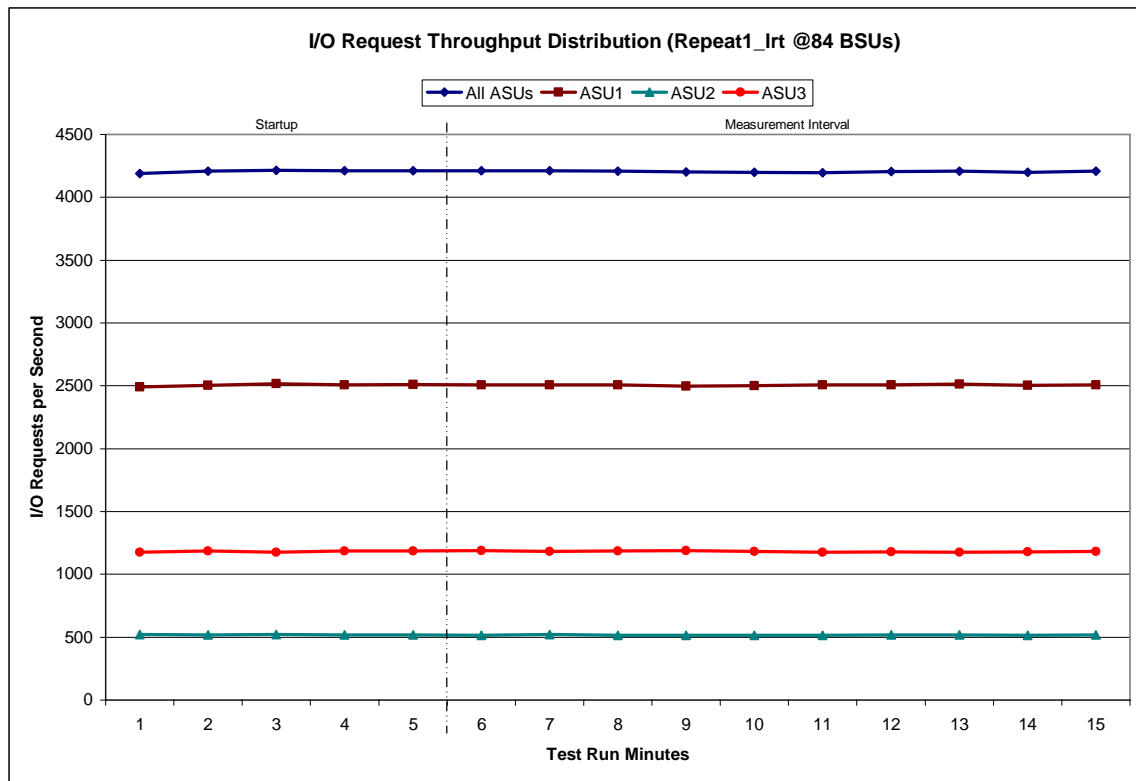

**Repeatability 1 LRT –Average Response Time (ms) Distribution Data**

| 84 BSUs                     | Start    | Stop     | Interval | Duration |
|-----------------------------|----------|----------|----------|----------|
| <i>Start-Up/Ramp-Up</i>     | 19:00:07 | 19:05:07 | 0-4      | 0:05:00  |
| <i>Measurement Interval</i> | 19:05:07 | 19:15:07 | 5-14     | 0:10:00  |
| 60 second intervals         | All ASUs | ASU1     | ASU2     | ASU3     |
| 0                           | 2.06     | 2.69     | 2.60     | 0.46     |
| 1                           | 2.11     | 2.75     | 2.75     | 0.50     |
| 2                           | 2.13     | 2.76     | 2.73     | 0.50     |
| 3                           | 2.13     | 2.77     | 2.75     | 0.51     |
| 4                           | 2.13     | 2.76     | 2.76     | 0.50     |
| 5                           | 2.13     | 2.77     | 2.74     | 0.50     |
| 6                           | 2.13     | 2.77     | 2.76     | 0.51     |
| 7                           | 2.15     | 2.81     | 2.78     | 0.50     |
| 8                           | 2.16     | 2.81     | 2.78     | 0.51     |
| 9                           | 2.22     | 2.90     | 2.90     | 0.50     |
| 10                          | 2.13     | 2.77     | 2.77     | 0.50     |
| 11                          | 2.13     | 2.76     | 2.74     | 0.51     |
| 12                          | 2.14     | 2.77     | 2.80     | 0.50     |
| 13                          | 2.13     | 2.77     | 2.75     | 0.50     |
| 14                          | 2.12     | 2.75     | 2.70     | 0.51     |
| Average                     | 2.14     | 2.79     | 2.77     | 0.50     |

**Repeatability 1 LRT –Average Response Time (ms) Distribution Graph**

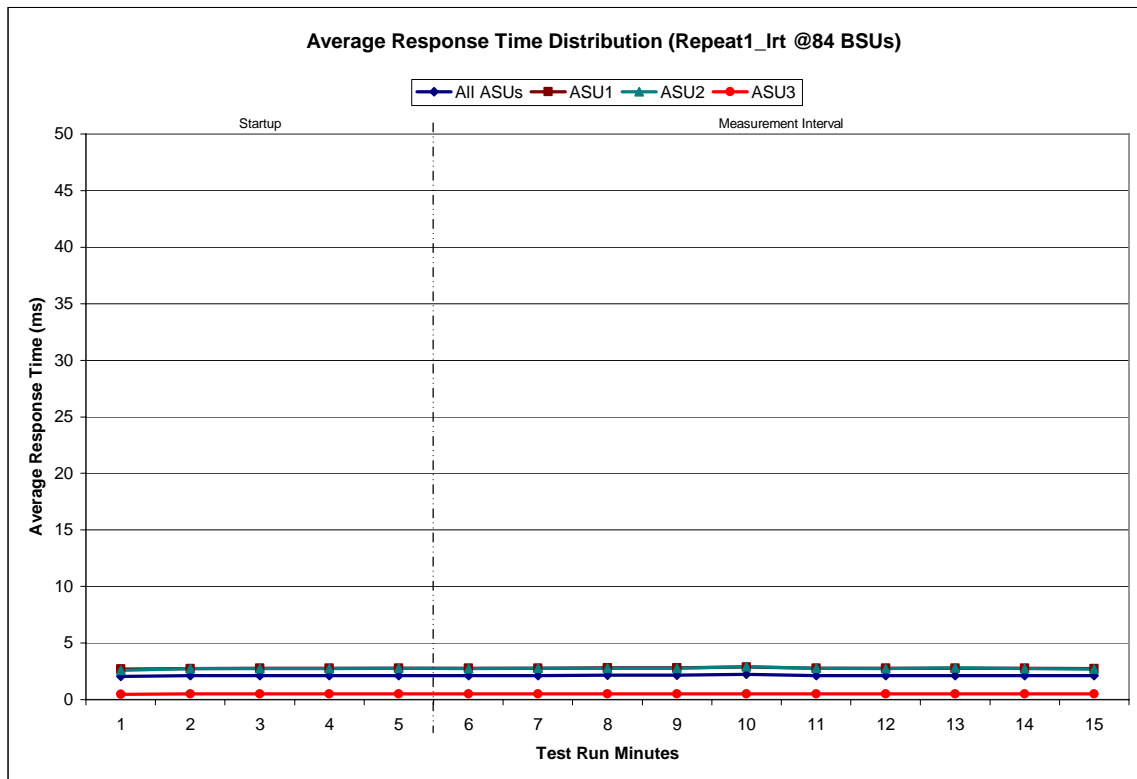

**Repeatability 1 IOPS - I/O Request Throughput Distribution Data**

| 845 BSUs                    | Start     | Stop      | Interval | Duration  |
|-----------------------------|-----------|-----------|----------|-----------|
| <i>Start-Up/Ramp-Up</i>     | 19:15:25  | 19:20:26  | 0-4      | 0:05:01   |
| <i>Measurement Interval</i> | 19:20:26  | 19:30:26  | 5-14     | 0:10:00   |
| 60 second intervals         | All ASUs  | ASU1      | ASU2     | ASU3      |
| 0                           | 42,273.45 | 25,203.12 | 5,185.72 | 11,884.62 |
| 1                           | 42,279.35 | 25,208.03 | 5,193.35 | 11,877.97 |
| 2                           | 42,230.23 | 25,154.92 | 5,192.82 | 11,882.50 |
| 3                           | 42,275.05 | 25,199.95 | 5,206.88 | 11,868.22 |
| 4                           | 42,220.05 | 25,159.62 | 5,192.80 | 11,867.63 |
| 5                           | 42,290.98 | 25,206.83 | 5,205.37 | 11,878.78 |
| 6                           | 42,202.93 | 25,142.13 | 5,178.55 | 11,882.25 |
| 7                           | 42,203.67 | 25,150.45 | 5,198.65 | 11,854.57 |
| 8                           | 42,234.23 | 25,173.27 | 5,183.42 | 11,877.55 |
| 9                           | 42,262.18 | 25,190.25 | 5,193.80 | 11,878.13 |
| 10                          | 42,251.93 | 25,189.08 | 5,199.08 | 11,863.77 |
| 11                          | 42,266.62 | 25,195.67 | 5,200.65 | 11,870.30 |
| 12                          | 42,248.37 | 25,220.80 | 5,183.73 | 11,843.83 |
| 13                          | 42,280.80 | 25,220.43 | 5,195.97 | 11,864.40 |
| 14                          | 42,257.30 | 25,172.52 | 5,199.08 | 11,885.70 |
| <b>Average</b>              | 42,249.90 | 25,186.14 | 5,193.83 | 11,869.93 |

**Repeatability 1 IOPS - I/O Request Throughput Distribution Graph**

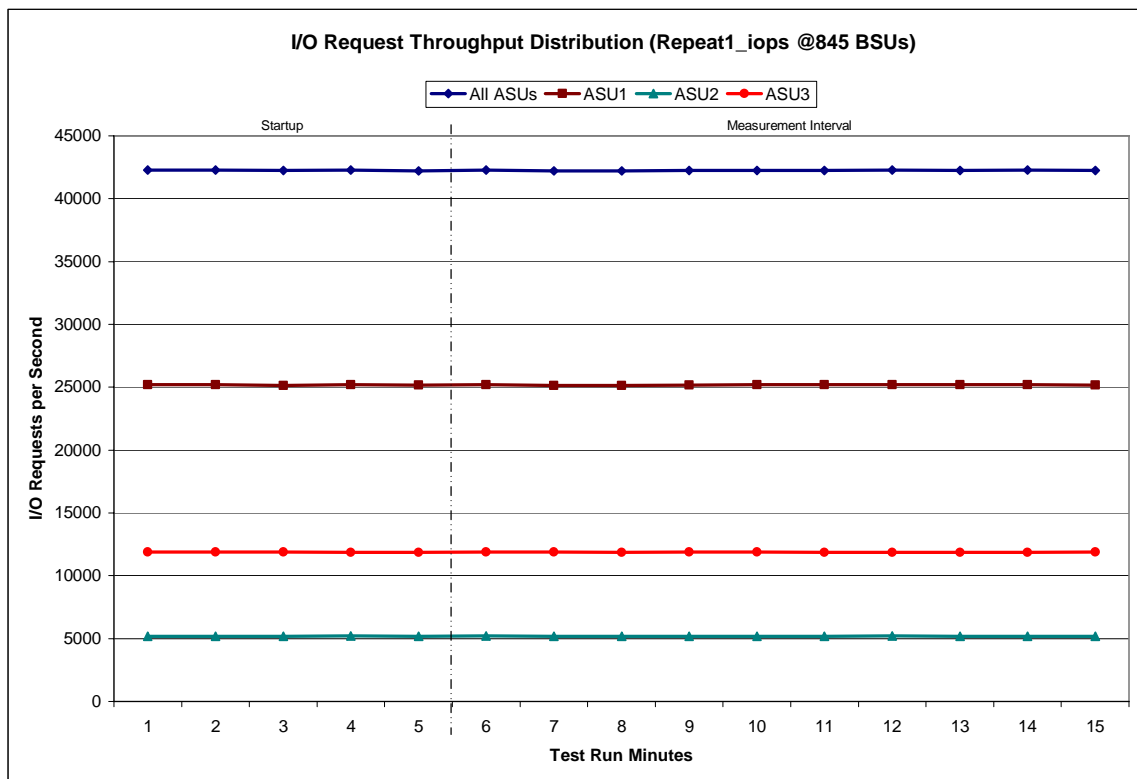

**Repeatability 1 IOPS –Average Response Time (ms) Distribution Data**

| 845 BSUs                    | Start    | Stop     | Interval | Duration |
|-----------------------------|----------|----------|----------|----------|
| <i>Start-Up/Ramp-Up</i>     | 19:15:25 | 19:20:26 | 0-4      | 0:05:01  |
| <i>Measurement Interval</i> | 19:20:26 | 19:30:26 | 5-14     | 0:10:00  |
| 60 second intervals         | All ASUs | ASU1     | ASU2     | ASU3     |
| 0                           | 20.66    | 20.90    | 26.11    | 17.78    |
| 1                           | 16.14    | 16.46    | 21.67    | 13.07    |
| 2                           | 16.45    | 16.76    | 22.00    | 13.36    |
| 3                           | 16.46    | 16.77    | 22.01    | 13.35    |
| 4                           | 16.12    | 16.46    | 21.64    | 12.98    |
| 5                           | 16.30    | 16.63    | 21.84    | 13.16    |
| 6                           | 16.13    | 16.47    | 21.66    | 12.98    |
| 7                           | 16.17    | 16.50    | 21.70    | 13.05    |
| 8                           | 16.23    | 16.56    | 21.75    | 13.11    |
| 9                           | 16.04    | 16.38    | 21.64    | 12.87    |
| 10                          | 16.20    | 16.54    | 21.69    | 13.07    |
| 11                          | 16.41    | 16.72    | 22.02    | 13.27    |
| 12                          | 16.19    | 16.52    | 21.65    | 13.07    |
| 13                          | 16.36    | 16.68    | 21.95    | 13.21    |
| 14                          | 16.32    | 16.65    | 21.82    | 13.22    |
| <b>Average</b>              | 16.23    | 16.57    | 21.78    | 13.10    |

**Repeatability 1 IOPS –Average Response Time (ms) Distribution Graph**

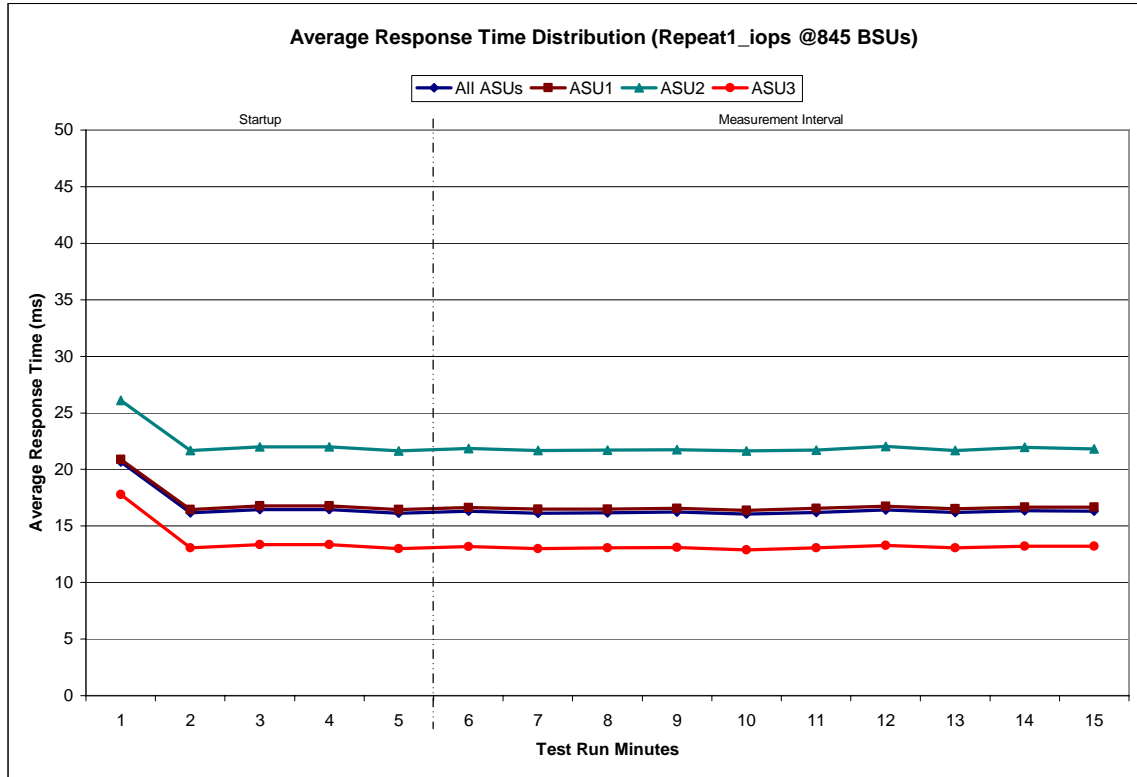

**Repeatability 2 LRT - I/O Request Throughput Distribution Data**

| 84 BSUs                     | Start    | Stop     | Interval | Duration |
|-----------------------------|----------|----------|----------|----------|
| <i>Start-Up/Ramp-Up</i>     | 19:30:49 | 19:35:49 | 0-4      | 0:05:00  |
| <i>Measurement Interval</i> | 19:35:49 | 19:45:49 | 5-14     | 0:10:00  |
| 60 second intervals         | All ASUs | ASU1     | ASU2     | ASU3     |
| 0                           | 4,196.40 | 2,493.87 | 513.45   | 1,189.08 |
| 1                           | 4,212.82 | 2,514.67 | 517.97   | 1,180.18 |
| 2                           | 4,214.77 | 2,508.67 | 517.65   | 1,188.45 |
| 3                           | 4,206.68 | 2,508.83 | 515.72   | 1,182.13 |
| 4                           | 4,203.22 | 2,508.20 | 517.90   | 1,177.12 |
| 5                           | 4,210.15 | 2,513.88 | 518.33   | 1,177.93 |
| 6                           | 4,203.53 | 2,506.12 | 511.97   | 1,185.45 |
| 7                           | 4,205.05 | 2,508.58 | 518.98   | 1,177.48 |
| 8                           | 4,195.25 | 2,504.52 | 509.18   | 1,181.55 |
| 9                           | 4,202.35 | 2,498.93 | 517.28   | 1,186.13 |
| 10                          | 4,207.83 | 2,506.77 | 518.32   | 1,182.75 |
| 11                          | 4,203.38 | 2,498.12 | 525.02   | 1,180.25 |
| 12                          | 4,206.52 | 2,509.00 | 519.07   | 1,178.45 |
| 13                          | 4,208.77 | 2,511.70 | 516.28   | 1,180.78 |
| 14                          | 4,201.80 | 2,511.77 | 515.00   | 1,175.03 |
| <b>Average</b>              | 4,204.46 | 2,506.94 | 516.94   | 1,180.58 |

**Repeatability 2 LRT - I/O Request Throughput Distribution Graph**

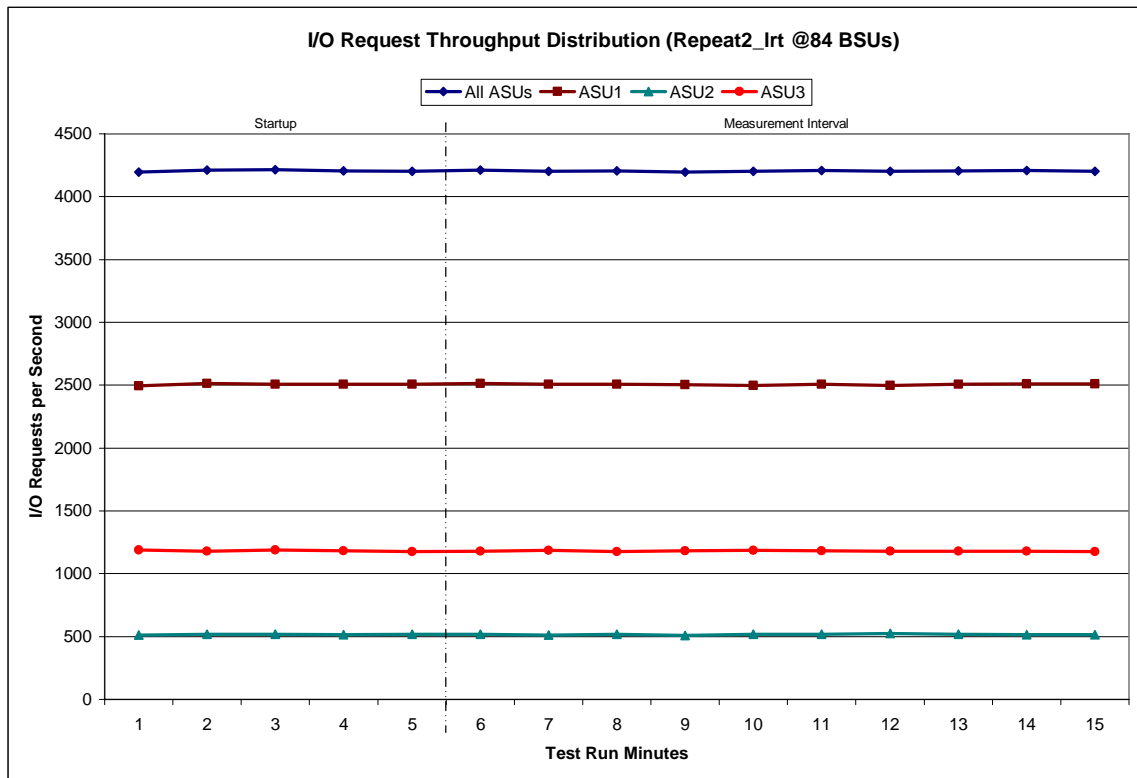

**Repeatability 2 LRT –Average Response Time (ms) Distribution Data**

| 84 BSUs                     | Start    | Stop     | Interval | Duration |
|-----------------------------|----------|----------|----------|----------|
| <i>Start-Up/Ramp-Up</i>     | 19:30:49 | 19:35:49 | 0-4      | 0:05:00  |
| <i>Measurement Interval</i> | 19:35:49 | 19:45:49 | 5-14     | 0:10:00  |
| 60 second intervals         | All ASUs | ASU1     | ASU2     | ASU3     |
| 0                           | 2.05     | 2.69     | 2.65     | 0.46     |
| 1                           | 2.13     | 2.76     | 2.73     | 0.50     |
| 2                           | 2.13     | 2.77     | 2.74     | 0.50     |
| 3                           | 2.13     | 2.76     | 2.76     | 0.51     |
| 4                           | 2.12     | 2.75     | 2.74     | 0.50     |
| 5                           | 2.13     | 2.76     | 2.80     | 0.50     |
| 6                           | 2.11     | 2.75     | 2.73     | 0.50     |
| 7                           | 2.13     | 2.77     | 2.74     | 0.51     |
| 8                           | 2.13     | 2.77     | 2.73     | 0.50     |
| 9                           | 2.11     | 2.76     | 2.70     | 0.50     |
| 10                          | 2.12     | 2.75     | 2.76     | 0.50     |
| 11                          | 2.13     | 2.77     | 2.74     | 0.50     |
| 12                          | 2.13     | 2.77     | 2.73     | 0.50     |
| 13                          | 2.17     | 2.83     | 2.75     | 0.52     |
| 14                          | 2.34     | 3.05     | 3.09     | 0.50     |
| <b>Average</b>              | 2.15     | 2.80     | 2.78     | 0.50     |

**Repeatability 2 LRT –Average Response Time (ms) Distribution Graph**

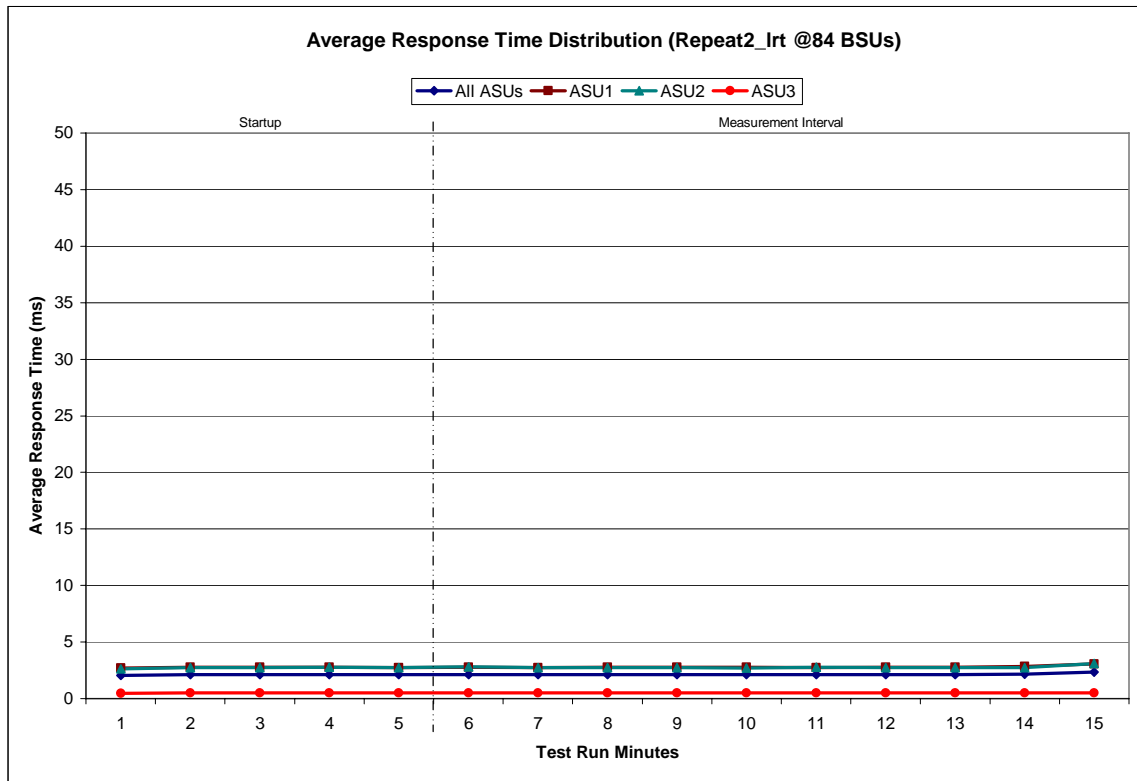

**Repeatability 2 IOPS - I/O Request Throughput Distribution Data**

| 845 BSUs             | Start     | Stop      | Interval | Duration  |
|----------------------|-----------|-----------|----------|-----------|
| Start-Up/Ramp-Up     | 19:46:08  | 19:51:09  | 0-4      | 0:05:01   |
| Measurement Interval | 19:51:09  | 20:01:09  | 5-14     | 0:10:00   |
| 60 second intervals  | All ASUs  | ASU1      | ASU2     | ASU3      |
| 0                    | 42,273.32 | 25,193.63 | 5,210.87 | 11,868.82 |
| 1                    | 42,226.05 | 25,184.88 | 5,177.68 | 11,863.48 |
| 2                    | 42,237.38 | 25,176.25 | 5,190.30 | 11,870.83 |
| 3                    | 42,242.60 | 25,164.63 | 5,189.72 | 11,888.25 |
| 4                    | 42,290.40 | 25,235.90 | 5,185.95 | 11,868.55 |
| 5                    | 42,222.03 | 25,189.35 | 5,186.40 | 11,846.28 |
| 6                    | 42,296.47 | 25,192.57 | 5,213.32 | 11,890.58 |
| 7                    | 42,231.95 | 25,164.62 | 5,186.10 | 11,881.23 |
| 8                    | 42,244.70 | 25,180.63 | 5,193.02 | 11,871.05 |
| 9                    | 42,258.02 | 25,192.27 | 5,195.72 | 11,870.03 |
| 10                   | 42,252.68 | 25,180.87 | 5,206.53 | 11,865.28 |
| 11                   | 42,258.47 | 25,199.53 | 5,190.13 | 11,868.80 |
| 12                   | 42,222.68 | 25,146.60 | 5,201.48 | 11,874.60 |
| 13                   | 42,270.03 | 25,205.55 | 5,199.45 | 11,865.03 |
| 14                   | 42,221.07 | 25,154.77 | 5,197.28 | 11,869.02 |
| Average              | 42,247.81 | 25,180.68 | 5,196.94 | 11,870.19 |

**Repeatability 2 IOPS - I/O Request Throughput Distribution Graph**

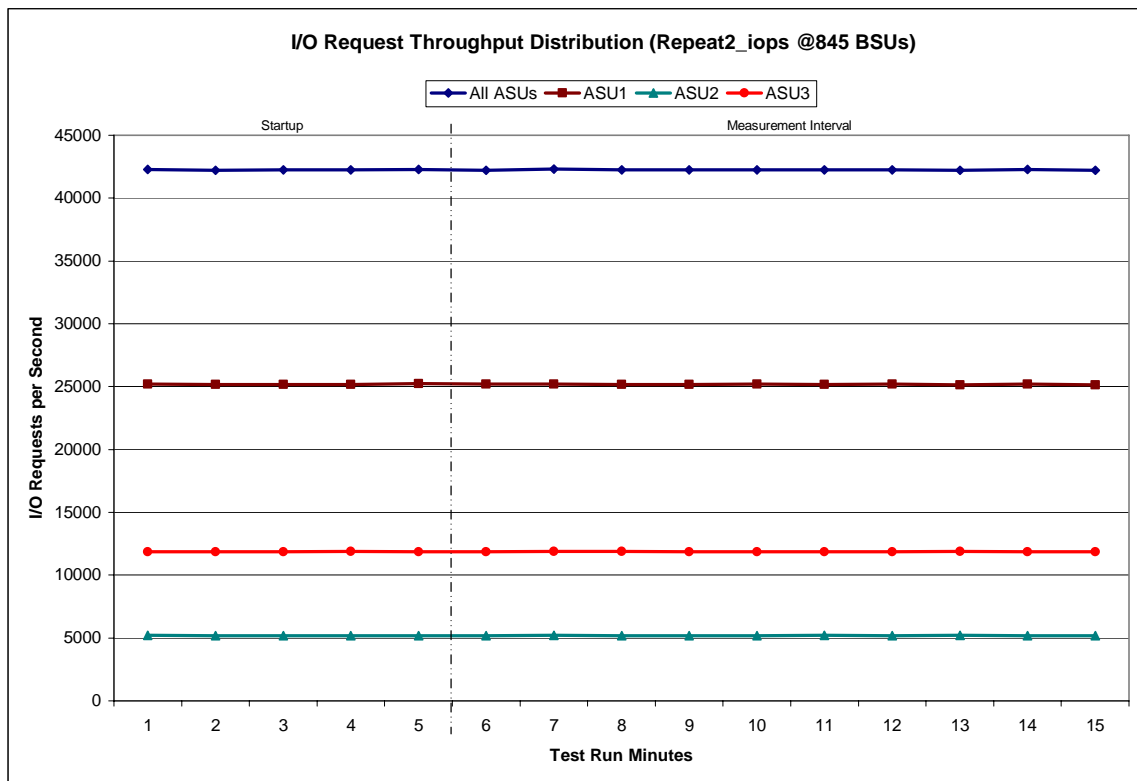



**Repeatability 2 IOPS –Average Response Time (ms) Distribution Data**

| 845 BSUs                    | Start    | Stop     | Interval | Duration |
|-----------------------------|----------|----------|----------|----------|
| <i>Start-Up/Ramp-Up</i>     | 19:46:08 | 19:51:09 | 0-4      | 0:05:01  |
| <i>Measurement Interval</i> | 19:51:09 | 20:01:09 | 5-14     | 0:10:00  |
| 60 second intervals         | All ASUs | ASU1     | ASU2     | ASU3     |
| 0                           | 19.34    | 19.54    | 24.82    | 16.50    |
| 1                           | 16.37    | 16.68    | 21.98    | 13.26    |
| 2                           | 15.99    | 16.34    | 21.41    | 12.85    |
| 3                           | 17.09    | 17.38    | 22.83    | 13.98    |
| 4                           | 16.38    | 16.72    | 22.05    | 13.19    |
| 5                           | 16.00    | 16.37    | 21.40    | 12.85    |
| 6                           | 16.59    | 16.88    | 22.14    | 13.54    |
| 7                           | 16.36    | 16.70    | 21.93    | 13.21    |
| 8                           | 16.25    | 16.58    | 21.79    | 13.13    |
| 9                           | 16.73    | 17.02    | 22.32    | 13.65    |
| 10                          | 16.37    | 16.73    | 21.91    | 13.18    |
| 11                          | 16.28    | 16.64    | 21.95    | 13.06    |
| 12                          | 16.43    | 16.77    | 22.01    | 13.26    |
| 13                          | 16.17    | 16.54    | 21.76    | 12.95    |
| 14                          | 16.43    | 16.75    | 21.95    | 13.35    |
| <b>Average</b>              | 16.36    | 16.70    | 21.92    | 13.22    |

**Repeatability 2 IOPS –Average Response Time (ms) Distribution Graph**

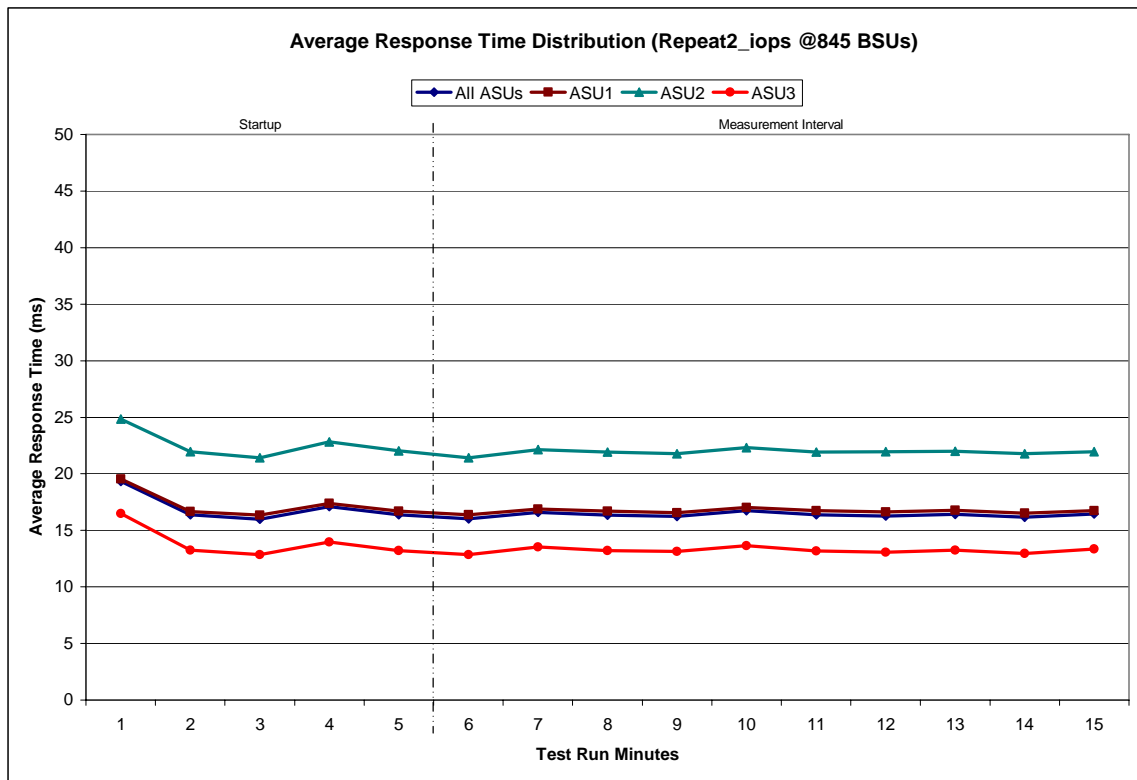

**Repeatability 1 (LRT)**  
**Measured Intensity Multiplier and Coefficient of Variation**

|     | ASU1-1 | ASU1-2 | ASU1-3 | ASU1-4 | ASU2-1 | ASU2-2 | ASU2-3 | ASU3-1 |
|-----|--------|--------|--------|--------|--------|--------|--------|--------|
| IM  | 0.0350 | 0.2810 | 0.0700 | 0.2100 | 0.0180 | 0.0700 | 0.0350 | 0.2810 |
| MIM | 0.0350 | 0.2808 | 0.0701 | 0.2100 | 0.0179 | 0.0701 | 0.0350 | 0.2811 |
| COV | 0.006  | 0.002  | 0.006  | 0.003  | 0.013  | 0.006  | 0.009  | 0.004  |

Clause 3.4.3

**IM - Intensity Multiplier:** The ratio of I/Os for each I/O stream relative to the total I/Os for all I/O streams (ASU1-1 – ASU3-1) as required by the benchmark specification.

Clauses 5.1.0 and 5.3.13.2

**MIM - Measured Intensity Multiplier:** The Measured Intensity Multiplier represents the ratio of measured I/Os for each I/O stream relative to the total I/Os measured for all I/O streams (ASU1-1 – ASU3-1). This value may differ from the corresponding Expected Intensity Multiplier by no more than 5%.

Clause 5.3.13.3

**COV - Coefficient of Variation:** This measure of variation for the Measured Intensity Multiplier cannot exceed 0.2.

**Repeatability 1 (IOPS)**  
**Measured Intensity Multiplier and Coefficient of Variation**

|     | ASU1-1 | ASU1-2 | ASU1-3 | ASU1-4 | ASU2-1 | ASU2-2 | ASU2-3 | ASU3-1 |
|-----|--------|--------|--------|--------|--------|--------|--------|--------|
| IM  | 0.0350 | 0.2810 | 0.0700 | 0.2100 | 0.0180 | 0.0700 | 0.0350 | 0.2810 |
| MIM | 0.0350 | 0.2811 | 0.0700 | 0.2100 | 0.0180 | 0.0699 | 0.0350 | 0.2809 |
| COV | 0.003  | 0.001  | 0.002  | 0.002  | 0.005  | 0.003  | 0.004  | 0.001  |

**Repeatability 2 (LRT)**  
**Measured Intensity Multiplier and Coefficient of Variation**

|     | ASU1-1 | ASU1-2 | ASU1-3 | ASU1-4 | ASU2-1 | ASU2-2 | ASU2-3 | ASU3-1 |
|-----|--------|--------|--------|--------|--------|--------|--------|--------|
| IM  | 0.0350 | 0.2810 | 0.0700 | 0.2100 | 0.0180 | 0.0700 | 0.0350 | 0.2810 |
| MIM | 0.0350 | 0.2811 | 0.0700 | 0.2102 | 0.0180 | 0.0703 | 0.0347 | 0.2808 |
| COV | 0.014  | 0.003  | 0.005  | 0.003  | 0.011  | 0.009  | 0.012  | 0.003  |

**Repeatability 2 (IOPS)**  
**Measured Intensity Multiplier and Coefficient of Variation**

|           | ASU1-1 | ASU1-2 | ASU1-3 | ASU1-4 | ASU2-1 | ASU2-2 | ASU2-3 | ASU3-1 |
|-----------|--------|--------|--------|--------|--------|--------|--------|--------|
| <i>IM</i> | 0.0350 | 0.2810 | 0.0700 | 0.2100 | 0.0180 | 0.0700 | 0.0350 | 0.2810 |
| MIM       | 0.0350 | 0.2810 | 0.0700 | 0.2100 | 0.0180 | 0.0700 | 0.0350 | 0.2810 |
| COV       | 0.005  | 0.001  | 0.002  | 0.001  | 0.004  | 0.002  | 0.004  | 0.001  |

## Data Persistence Test

### Clause 6

*The Data Persistence Test demonstrates the Tested Storage Configuration (TSC):*

- *Is capable of maintain data integrity across a power cycle.*
- *Ensures the transfer of data between Logical Volumes and host systems occurs without corruption or loss.*

*The SPC-1 Workload Generator will write 16 block I/O requests at random over the total Addressable Storage Capacity of the TSC for ten (10) minutes at a minimum of 25% of the load used to generate the SPC-1 IOP™ primary metric. The bit pattern selected to be written to each block as well as the address of the block will be retained in a log file.*

*The Benchmark Configuration will be shutdown and restarted using a power off/power on cycle at the end of the above sequence of write operations. In addition, any caches employing battery backup must be flushed/emptied.*

*The SPC-1 Workload Generator will then use the above log file to verify each block written contains the correct bit pattern.*

### Clause 9.2.4.8

*The following content shall appear in this section of the FDR:*

1. *A listing or screen image of all input parameters supplied to the Workload Generator.*
2. *For the successful Data Persistence Test Run, a table illustrating key results. .... Information displayed in this table shall be obtained from the Test Run Results File referenced below in #3.*
3. *For the successful Data Persistence Test Run, the human readable Test Run Results File produced by the Workload Generator.*

## SPC-1 Workload Generator Input Parameters

The SPC-1 Workload Generator input parameters for the Persistence Test Run 1 and Persistence Test Run 2 are listed below.

```
java -Xms512m -Xmx512m persist1 -b 845
```

```
java -Xms512m -Xmx512m persist2
```

## Data Persistence Test Results File

A link to each test result file generated from each Data Persistence Test is listed below.

[Persistence 1 Test Results File](#)

[Persistence 2 Test Results File](#)

### Data Persistence Test Results

| <b>Data Persistence Test Results</b>                     |            |
|--|------------|
| Data Persistence Test Run Number: 1                      |            |
| Total Number of Logical Blocks Written                   | 48,807,872 |
| Total Number of Logical Blocks Verified                  | 44,089,264 |
| Total Number of Logical Blocks that Failed Verification  | 0          |
| Time Duration for Writing Test Logical Blocks            | 10 minutes |
| Size in Bytes of each Logical Block                      | 512        |
| Number of Failed I/O Requests in the process of the Test | 0          |

In some cases the same address was the target of multiple writes, which resulted in more Logical Blocks Written than Logical Blocks Verified. In the case of multiple writes to the same address, the pattern written and verified must be associated with the last write to that address.

## **PRICED STORAGE CONFIGURATION AVAILABILITY DATE**

### Clause 9.2.4.9

*The committed delivery data for general availability (Availability Date) of all products that comprise the Priced Storage Configuration must be reported. When the Priced Storage Configuration includes products or components with different availability dates, the reported Availability Date must be the date at which all components are committed to be available.*

*The FDR shall state: "The Priced Storage Configuration, as documented in this Full Disclosure Report will be available for shipment to customers on MMMM DD, YYYY." Where Priced Storage Configuration is the TSC Configuration Name as described in Clause 9.2.4.3.3 and MMMM is the alphanumeric month, DD is the numeric day, and YYYY is the numeric year of the date that the Priced Storage Configuration, as documented, is available for shipment to customers as described above.*

**The Sun StorageTek® FlexLine™ FLX380 Storage System, as documented in this Full Disclosure Report will become available for customer purchase and shipment on May 16, 2005.**

## **PRICING INFORMATION**

### Clause 9.2.4.11.1

*A statement of the respective calculations for pricing must be included.*

### Clause 9.2.4.11.3

*A list of all differences between the Tested Storage Configuration (TSC) and Priced Storage Configuration must be included.*

**Pricing information may found in the Tested Storage Configuration Pricing section on page 12. A list of all differences between the Tested Storage Configuration (TSC) and Priced Storage Configuration may be found in the Executive Summary portion of this document on page 12.**

## **ANOMALIES OR IRREGULARITIES**

### Clause 9.2.4.10

*The FDR shall include a clear and complete description of any anomalies or irregularities encountered in the course of executing the SPC-1 benchmark that may in any way call into question the accuracy, verifiability, or authenticity of information published in this FDR.*

**There were no anomalies or irregularities encountered during the SPC-1 Remote Audit of the Sun StorageTek® FlexLine™ FLX380 Storage System.**

## **APPENDIX A: CUSTOMER TUNABLE PARAMETERS AND OPTIONS**

### **Windows 2000 Registry Changes**

HKEY\_LOCAL\_MACHINE\SYSTEM\CurrentControlSet\Services\  
ql2300\Device\MaximumSGList=0xff

HKEY\_LOCAL\_MACHINE\SYSTEM\CurrentControlSet\Services\  
ql2300\Device\NumberOfRequests=0xfe

HKEY\_LOCAL\_MACHINE\SYSTEM\CurrentControlSet\Services\  
Disk\TimeOutValue=0x78

HKEY\_LOCAL\_MACHINE\SYSTEM\CurrentControlSet\Services\  
ql2300\Device\DriverParameters=UseSameNN=1;BusChange=0;

### **Storage Array Cache Flush Settings**

**Start Flush:** changed from default of 80 to new value of 50

**Stop Flush:** changed from default of 80 to new value of 50

### **RDAC Failover Options**

| Host Region | Offset | Default | New Value |
|-------------|--------|---------|-----------|
| 3           | 0x24   | 1       | 0         |
| 9           | 0x24   | 1       | 0         |
| 10          | 0x24   | 1       | 0         |
| 11          | 0x24   | 1       | 0         |
| 12          | 0x24   | 1       | 0         |
| 13          | 0x24   | 1       | 0         |
| 14          | 0x24   | 1       | 0         |

## Host Bus Adapter Options

The table below lists the Host Bus Adapter BIOS options that were changed from their default values.

| Host Bus Adapter Settings         |          |           |
|-----------------------------------|----------|-----------|
| Item                              | Default  | New Value |
| <b>Adapter Settings:</b>          |          |           |
| Loop Reset Delay                  | 5        | 8         |
| Adapter Hard Loop ID              | Disabled | Enabled   |
| Hard Loop ID (unique for each)    | 0        | Eg. 22    |
| Fibre Channel Tape Support        | Enabled  | Disabled  |
| <b>Advanced Adapter Settings:</b> |          |           |
| Execution Throttle                | 16       | 255       |
| LUNs per Target                   | 8        | 0         |
| Login Retry Count                 | 8        | 30        |
| Port Down Retry Count             | 8        | 70        |
| Link Down Timeout                 | 30       | 60        |



## **APPENDIX B: TESTED STORAGE CONFIGURATION (TSC) CREATION**

The storage management utility, SANtricity, was used to create eight volume groups on the storage subsystem, each volume group contains a single volume. The SANtricity script is listed below. These eight volumes are visible by each of the attached hosts. There are four hosts used in this benchmark. One host is the “master”, and is not configured to issue IO to the storage subsystem. The other three “slave” hosts, configured with three JVM's each, perform the IO for the benchmark. The steps that follow are required to define the Windows partitions, volumes, and stripe sets that will be used by the SPC-1 benchmark. Steps 1-8 below are performed on only one of the hosts

- (1) Use diskpar.exe to set the starting offset for each of the storage system volumes. Starting offset is 65536. Use all of the remaining capacity in the partition.
- (2) Start Windows Disk Administrator.
- (3) Convert all of the storage system volumes to Dynamic Disks.
- (4) Create a Windows Striped (RAID 0) volume using all eight 32MB volumes.
- (5) Delete the large volume on each of the Dynamic Disks.
- (6) Create a Windows Striped (RAID 0) volume for ASU 3.
  - a. Select all eight volumes.
  - b. Set capacity to 81910MB.
  - c. Assign drive letter “N” to the volume. Do not format the volume.
- (7) Create the Windows Striped (RAID0) volume for ASU 1.
  - a. Select all eight volumes.
  - b. Set capacity to 368595MB.
  - c. Assign drive letter “L” to the volume. Do not format the volume.
- (8) Create the Windows Striped (RAID 0 ) volume for ASU 2.
  - a. Select all eight volumes.
  - b. Set capacity to 368595MB.
  - c. Assign drive letter “M” to the volume. Do not format the volume.
- (9) Reboot all four host systems.
- (10) After reboot completes, start Disk Administrator on each of the host systems.
- (11) Import foreign disks, or reactive the Windows stripe sets as necessary. On each host, assign drive letters to the stripe sets as they were assigned in steps 6, 7, and 8.

## SANtricity Volume Creation Script

```
set controller[b] mode = Active;

create volume drives[ 10,1 10,2 30,1 30,2 10,3 10,4 30,3 30,4 10,5 30,5 10,6
30,6 10,7 10,8
30,7 30,8 10,9 10,10 30,9 30,10 10,11 10,12 30,11 30,12 10,13
10,14 30,13 30,14 ]
RAIDLevel=1
segmentSize=128
userLabel="LUN_0"
capacity=899gb
owner = A;
create volume drives[ 11,1 11,2 31,1 31,2 11,3 11,4 31,3 31,4 11,5 11,6 31,5
31,6 11,7 11,8
31,7 31,8 11,9 11,10 31,9 31,10 11,11 11,12 31,11 31,12 11,13
11,14 31,13 31,14 ]
RAIDLevel=1
segmentSize=128
userLabel="LUN_1"
capacity=899gb
owner = A;
create volume drives[ 12,1 12,2 32,1 32,2 12,3 12,4 32,3 32,4 12,5 12,6 32,5
32,6 12,7 12,8
32,7 32,8 12,9 12,10 32,9 32,10 12,11 12,12 32,11 32,12 12,13
12,14 32,13 32,14 ]
RAIDLevel=1
segmentSize=128
userLabel="LUN_2"
capacity=899gb
owner = A;
create volume drives[ 13,1 13,2 33,1 33,2 13,3 13,4 33,3 33,4 13,5 13,6 33,5
33,6 13,7 13,8
33,7 33,8 13,9 13,10 33,9 33,10 13,11 13,12 33,11 33,12 13,13
13,14 33,13 33,14 ]
RAIDLevel=1
segmentSize=128
userLabel="LUN_3"
capacity=899gb
owner = A;
create volume drives[ 20,1 20,2 40,1 40,2 20,3 20,4 40,3 40,4 20,5 20,6 40,5
40,6 20,7 20,8
40,7 40,8 20,9 20,10 40,9 40,10 20,11 20,12 40,11 40,12 20,13
20,14 40,13 40,14 ]
RAIDLevel=1
segmentSize=128
userLabel="LUN_4"
capacity=899gb
owner = b;
create volume drives[ 21,1 21,2 41,1 41,2 21,3 21,4 41,3 41,4 21,5 21,6 41,5
41,6 21,7 21,8
41,7 41,8 21,9 21,10 41,9 41,10 21,11 21,12 41,11 41,12 21,13
21,14 41,13 41,14 ]
RAIDLevel=1
segmentSize=128
userLabel="LUN_5"
capacity=899gb
owner = b;
create volume drives[ 22,1 22,2 42,1 42,2 22,3 22,4 42,3 42,4 22,5 22,6 42,5
42,6 22,7 22,8
```

```

                42,7 42,8 22,9 22,10 42,9 42,10 22,11 22,12 42,11 42,12 22,13
22,14 42,13 42,14 ]
RAIDLevel=1
segmentSize=128
userLabel="LUN_6"
capacity=899gb
owner = b;
create volume drives[ 23,1 23,2 43,1 43,2 23,3 23,4 43,3 43,4 23,5 23,6 43,5
43,6 23,7 23,8
                43,7 43,8 23,9 23,10 43,9 43,10 23,11 23,12 43,11 43,12 23,13
23,14 43,13 43,14 ]
RAIDLevel=1
segmentSize=128
userLabel="LUN_7"
capacity=899gb
owner = b;

set volume["LUN_0"] mirrorEnabled = True writeCacheEnabled = True
cacheWithoutBatteryEnabled = True readAheadMultiplier = 0;
set volume["LUN_1"] mirrorEnabled = True writeCacheEnabled = True
cacheWithoutBatteryEnabled = True readAheadMultiplier = 0;
set volume["LUN_2"] mirrorEnabled = True writeCacheEnabled = True
cacheWithoutBatteryEnabled = True readAheadMultiplier = 0;
set volume["LUN_3"] mirrorEnabled = True writeCacheEnabled = True
cacheWithoutBatteryEnabled = True readAheadMultiplier = 0;
set volume["LUN_4"] mirrorEnabled = True writeCacheEnabled = True
cacheWithoutBatteryEnabled = True readAheadMultiplier = 0;
set volume["LUN_5"] mirrorEnabled = True writeCacheEnabled = True
cacheWithoutBatteryEnabled = True readAheadMultiplier = 0;
set volume["LUN_6"] mirrorEnabled = True writeCacheEnabled = True
cacheWithoutBatteryEnabled = True readAheadMultiplier = 0;
set volume["LUN_7"] mirrorEnabled = True writeCacheEnabled = True
cacheWithoutBatteryEnabled = True readAheadMultiplier = 0;

set storageArray cacheBlockSize = 4;
set storageArray cacheFlushStart = 50 cacheFlushStop = 50;

set storageArray defaultHostType = "Windows 2000/Server 2003 Non-Clustered";

set controller[a] HostNVS RAMByte[0x01, 0x17]=0x01;
set controller[b] HostNVS RAMByte[0x01, 0x17]=0x01;

/* Setup for RDAC failover environment */

set controller[a] HostNVS RAMByte[0x00, 0x24]=0x00;
set controller[a] HostNVS RAMByte[0x01, 0x24]=0x00;
set controller[a] HostNVS RAMByte[0x02, 0x24]=0x00;
set controller[a] HostNVS RAMByte[0x03, 0x24]=0x00;
set controller[a] HostNVS RAMByte[0x04, 0x24]=0x00;
set controller[a] HostNVS RAMByte[0x05, 0x24]=0x00;
set controller[a] HostNVS RAMByte[0x06, 0x24]=0x00;
set controller[a] HostNVS RAMByte[0x07, 0x24]=0x00;
set controller[a] HostNVS RAMByte[0x08, 0x24]=0x00;
set controller[a] HostNVS RAMByte[0x09, 0x24]=0x00;
set controller[a] HostNVS RAMByte[0x0a, 0x24]=0x00;
set controller[a] HostNVS RAMByte[0x0b, 0x24]=0x00;
set controller[a] HostNVS RAMByte[0x0c, 0x24]=0x00;
set controller[a] HostNVS RAMByte[0x0d, 0x24]=0x00;
set controller[a] HostNVS RAMByte[0x0e, 0x24]=0x00;
set controller[a] HostNVS RAMByte[0x0f, 0x24]=0x00;

set controller[b] HostNVS RAMByte[0x00, 0x24]=0x00;
set controller[b] HostNVS RAMByte[0x01, 0x24]=0x00;
```

**APPENDIX B:**  
**TESTED STORAGE CONFIGURATION (TSC) CREATION**

```
set controller[b] HostNVSARAMByte[0x02, 0x24]=0x00;  
set controller[b] HostNVSARAMByte[0x03, 0x24]=0x00;  
set controller[b] HostNVSARAMByte[0x04, 0x24]=0x00;  
set controller[b] HostNVSARAMByte[0x05, 0x24]=0x00;  
set controller[b] HostNVSARAMByte[0x06, 0x24]=0x00;  
set controller[b] HostNVSARAMByte[0x07, 0x24]=0x00;  
set controller[b] HostNVSARAMByte[0x08, 0x24]=0x00;  
set controller[b] HostNVSARAMByte[0x09, 0x24]=0x00;  
set controller[b] HostNVSARAMByte[0x0a, 0x24]=0x00;  
set controller[b] HostNVSARAMByte[0x0b, 0x24]=0x00;  
set controller[b] HostNVSARAMByte[0x0c, 0x24]=0x00;  
set controller[b] HostNVSARAMByte[0x0d, 0x24]=0x00;  
set controller[b] HostNVSARAMByte[0x0e, 0x24]=0x00;  
set controller[b] HostNVSARAMByte[0x0f, 0x24]=0x00;
```

## **APPENDIX C: SPC-1 WORKLOAD GENERATOR STORAGE COMMANDS AND PARAMETERS**

The contents of the SPC-1 Workload Generator command and parameter file is listed below.

### **Master Host System**

```
* spc1.cfg

host=master
slaves=(bm2650i_s1,bm2650i_s2,bm2650i_s3,bm2650n_s1,bm2650n_s2,bm2650n_s3,bm
2650o_s1,bm2650o_s2,bm2650o_s3)

javaparms="-Xmx256m -Xms256m"

sd=asu1_1,lun=\\.\\L:,size=3091998965760
sd=asu2_1,lun=\\.\\M:,size=3091998965760
sd=asu3_1,lun=\\.\\N:,size=687110881280

eof
```

### **Slave Host Systems**

One of the SPC-1 Workload Generator command and parameter files is listed below. The files were identical for each slave system with the exception of the "host=" value, which varied dependent upon the system.

```
*slavel.parm

host=bm2650i_s1
master=bm2650j

sd=asu1_1,lun=\\.\\L:,size=3091998965760
sd=asu2_1,lun=\\.\\M:,size=3091998965760
sd=asu3_1,lun=\\.\\N:,size=687110881280

eof
```