



SPC BENCHMARK 1™
FULL DISCLOSURE REPORT

HUAWEI TECHNOLOGIES CO., LTD.
OCEANSTOR 5310 V5

SPC-1 V3.8.0

SUBMISSION IDENTIFIER: A32013

SUBMITTED FOR REVIEW: MARCH 16, 2020

First Edition – March 2020

THE INFORMATION CONTAINED IN THIS DOCUMENT IS DISTRIBUTED ON AN AS IS BASIS WITHOUT ANY WARRANTY EITHER EXPRESS OR IMPLIED. The use of this information or the implementation of any of these techniques is the customer's responsibility and depends on the customer's ability to evaluate and integrate them into the customer's operational environment. While each item has been reviewed by Huawei Technologies Co., Ltd. for accuracy in a specific situation, there is no guarantee that the same or similar results will be obtained elsewhere. Customers attempting to adapt these techniques to their own environment do so at their own risk.

This publication was produced in the United States. Huawei Technologies Co., Ltd. may not offer the products, services, or features discussed in this document in other countries, and the information is subject to change with notice. Consult your local Huawei Technologies Co., Ltd. representative for information on products and services available in your area.

© Copyright Huawei Technologies Co., Ltd. 2020. All rights reserved.

Permission is hereby granted to publicly disclose and reproduce this document, in whole or in part, provided the copyright notice as printed above is set forth in full text on the title page of each item reproduced.

Trademarks

SPC Benchmark 1, SPC-1, SPC-1 IOPS, SPC-1 LRT and SPC-1 Price-Performance are trademarks of the Storage Performance Council.

Huawei, the Huawei logo, FusionServer, and OceanStor are trademarks or registered trademarks of Huawei Technologies Co., Ltd. in the United States and other countries. All other brands, trademarks, and product names are the property of their respective owners.

Benchmark Specification and Glossary

The official SPC Benchmark 1™ (SPC-1™) specification is available on the website of the Storage Performance Council (SPC) at www.spcresults.org.

The SPC-1™ specification contains a glossary of the SPC-1™ terms used in this publication.

Table of Contents

Audit Certification.....	4
Letter Of Good Faith.....	6
Executive Summary	7
Configuration Information	13
Benchmark Configuration and Tested Storage Configuration.....	13
Benchmark Configuration Creation Process	15
Benchmark Execution Results.....	17
Benchmark Execution Overview	17
SUSTAIN Test Phase.....	18
RAMPD_100 Test Phase.....	21
Response Time Ramp Test.....	24
Repeatability Test	26
Space Optimization Techniques.....	29
Data Persistence Test	30
Appendix A: Supporting Files	31
Appendix B: Third Party Quotation	32
Appendix C: Tuning Parameters and Options	33
Appendix D: Storage Configuration Creation	34
Step 1: Create Disk Domains, Storage Pools, LUNs, LUN Group.....	34
Step 2: Create Mapping View, Host Group and Host	35
Step 3: Create Volumes on the Master Host System.....	36
Step 4: Change the Scheduler on each Host System	36
Step 5: Change the nr_requests on each Host System	37
Step 6: Change the aio-max-nr on each Host System.....	37
Referenced Scripts.....	37
Appendix E: Configuration Inventory.....	38
Appendix F: Workload Generator	39

AUDIT CERTIFICATION

Zhong Xu
 Huawei Technologies Co., Ltd.
 Huawei Industrial Base, Bantian, Longgang
 Shenzhen city
 Guangdong province
 China

March 16, 2020

I verified the SPC Benchmark 1™ (SPC-1™ V3.8) test execution and performance results of the following Tested Storage Product:

OceanStor 5310 V5

The results were:

SPC-1 IOPS™	1,600,658
SPC-1 Price-Performance™	¥3,115.89/SPC-1 KIOPS™
SPC-1 IOPS™ Response Time	0.677 ms
SPC-1 Overall Response Time	0.353 ms
SPC-1 ASU Capacity	38,225 GB
SPC-1 ASU Price	¥130.48/GB
SPC-1 Total System Price	¥4,987,470.87

In my opinion, these performance results were produced in compliance with the SPC requirements for the benchmark.

The testing was executed using the SPC-1 Toolkit Version v3.0.2-1-g823a. The audit process was conducted in accordance with the SPC Policies and met the requirements for the benchmark.

A Letter of Good Faith was issued by the Test Sponsor, stating the accuracy and completeness of the documentation and testing data provided in support of the audit of this result.

A Full Disclosure Report for this result was prepared by InfoSizing, reviewed and approved by the Test Sponsor, and can be found at www.spcresults.org under the Submission Identifier A32013.

63 Lourdes Dr. | Leominster, MA 01453 | 978-343-6562 | www.sizing.com

Huawei Technologies Co., Ltd.

OceanStor 5310 V5

A32013

The independent audit process conducted by InfoSizing included the verifications of the following items:

- The physical capacity of the data repository;
- The total capacity of the Application Storage Unit (ASU);
- The accuracy of the Benchmark Configuration diagram;
- The tuning parameters used to configure the Benchmark Configuration;
- The Workload Generator commands used to execute the testing;
- The validity and integrity of the test result files;
- The compliance of the results from each performance test;
- The compliance of the results from each persistence test;
- The compliance of the submitted pricing model; and
- The differences between the tested and the priced configuration, if any.

The Full Disclosure Report for this result was prepared in accordance with the disclosure requirements set forth in the specification for the benchmark.

The following benchmark requirements, if any, were waived in accordance with the SPC Policies:

None.

Respectfully Yours,



Doug Johnson, Certified SPC Auditor

63 Lourdes Dr. | Leominster, MA 01453 | 978-343-6562 | www.sizing.com

LETTER OF GOOD FAITH



©Huawei Technologies Co., Ltd.
Huawei Industrial Base, Bantian, Longgang
Shenzhen city
Guangdong province
China
Tel: 0086-755-28780808
<http://www.huawei.com/cn/>

Date: March 16, 2020

From: Huawei Technologies Co., Ltd.

To: Doug Johnson, SPC Auditor
PerfLabs, Inc. DBA InfoSizing
63 Lourdes Drive
Leominster, MA 01453-6709 USA

Subject: SPC-1 Letter of Good Faith for the Huawei OceanStor 5310V5

Huawei Technologies Co., Ltd. is the SPC-1 Test Sponsor for the above listed product. To the best of our knowledge and belief, the required SPC-1 benchmark results and materials we have submitted for that product are complete, accurate, and in full compliance with V3.8 of the SPC-1 benchmark specification.

In addition, we have reported any items in the Benchmark Configuration and execution of the benchmark that affected the reported results even if the items are not explicitly required to be disclosed by the SPC-1 benchmark specification.

Signed:

A handwritten signature in black ink, appearing to read "Yuefeng Zhou", written over a horizontal line.

Yuefeng Zhou
Intelligent Data & Storage Product Line

Date:

A handwritten date "3/16/2020" in black ink, written over a horizontal line.



SPC BENCHMARK 1™

EXECUTIVE SUMMARY

HUAWEI TECHNOLOGIES CO., LTD. OCEANSTOR 5310 V5

SPC-1 IOPS™	1,600,658
SPC-1 Price-Performance™	¥3,115.89/SPC-1 KIOPS™
SPC-1 IOPS™ Response Time	0.677 ms
SPC-1 Overall Response Time	0.353 ms
SPC-1 ASU Capacity	38,225 GB
SPC-1 Space Effectiveness Ratio	NA
SPC-1 ASU Price	¥130.48/GB
SPC-1 Total System Price	¥4,987,470.87
Data Protection Level	Protected 2 (RAID10 and full redundancy)
Physical Storage Capacity	92,160 GB
Pricing Currency / Target Country	CNY / China

SPC-1 V3.8.0

SUBMISSION IDENTIFIER: A32013

SUBMITTED FOR REVIEW: MARCH 16, 2020

Benchmark Configuration Diagram

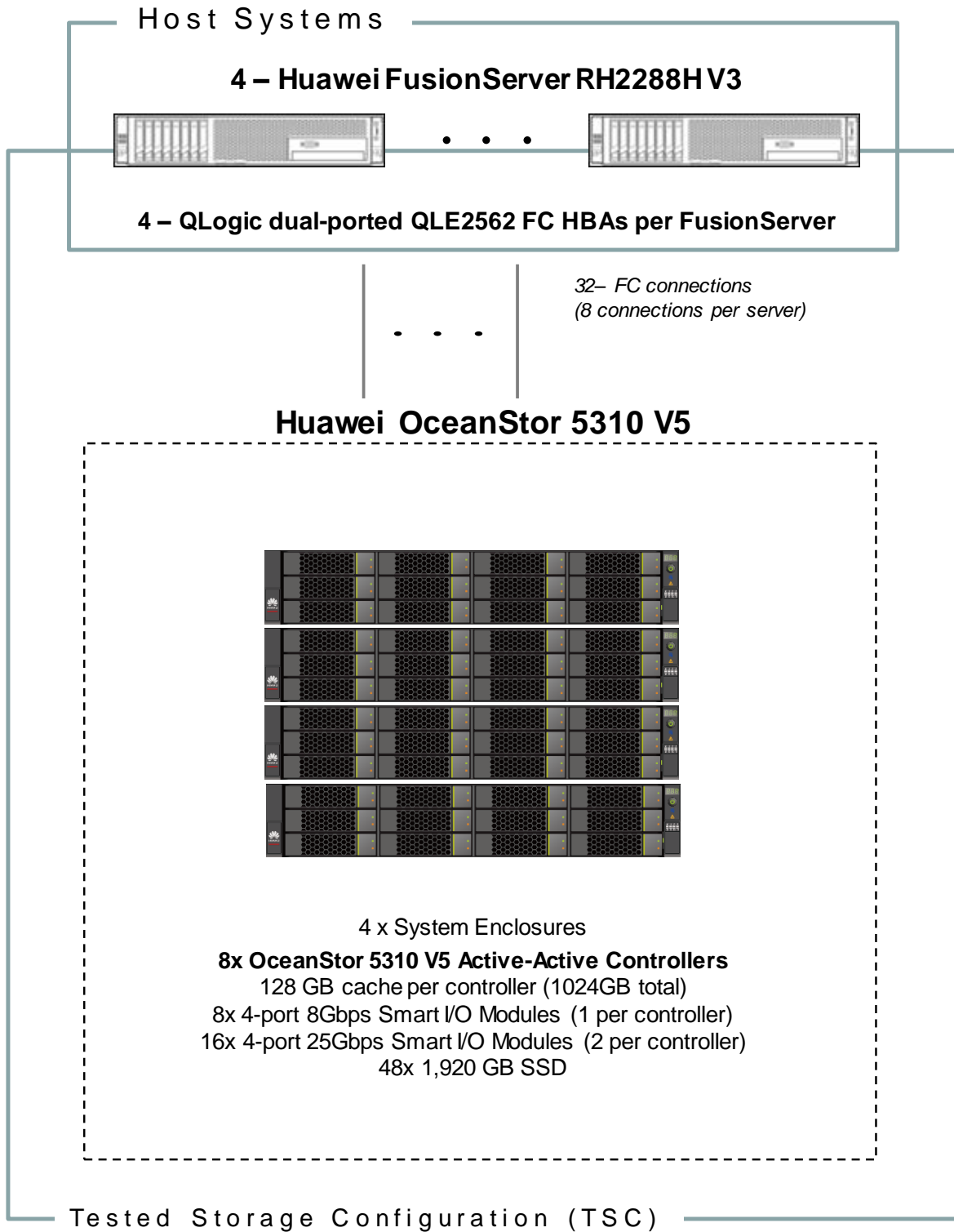

Tested Storage Product Description

The new generation of mid-range hybrid flash storage, dedicated to providing the reliable and efficient data services for enterprises.

Cloud-ready operating system, flash-enabled performance, and intelligent management software, delivering top-of-the-line functionality, performance, efficiency, reliability, and ease of use.

Satisfies the data storage requirements of large-database OLTP/OLAP, cloud computing, and many other applications, making it a perfect choice for sectors such as government, finance, telecommunications, and manufacturing.

For more details, visit:

<https://e.huawei.com/cn/products/cloud-computing-dc/storage/hybrid-flash-storage/oceanstor-5X10-v5>

Priced Storage Configuration Components

16 x QLogic dual-ported QLE2562 8 Gbps FC HBAs
8 x OceanStor 5310 V5 Active-Active Controllers (2 per enclosure), each with: 128 GB cache (1,024 GB total) 8 x 4-port 8 Gbps Smart I/O Modules (1 per controller) 16 x 4-port 25 Gbps Smart I/O Modules (2 per controller) 48 x 1,920 GB SSD Storage Devices (12 per enclosure)
4 x System/Disk Enclosures

Storage Configuration Pricing

Part No.	Description	Source	Qty	Unit Price	Ext. Price	Disc.	Disc. Price
Hardware & Software							
5310 V5-25-256-AC	5310 V5(2U,Dual Ctrl,SAS,AC)240V HVDC,256GB Cache,8*1Gb ETH,8*10Gb ETH,4*(4*12Gb) SAS,25*2.5",include 4*2*8Gb HBA)	1	4	1,249,907.25	4,999,629.00	73.5%	1,324,901.69
SMART8GbFE	4 ports SmartIO I/O module(SFP+,8Gb FC)	1	8	61,900.00	495,200.00	73.5%	131,228.00
25GeScale	4 ports 25Gb RDMA I/O module(SFP28,Scale-out for direct connection)	1	16	63,649.00	1,018,384.00	73.5%	269,871.76
L3-S-SSD1920	1.92TB SSD SAS Disk Unit(2.5")	1	48	237,180.00	11,384,640.00	73.5%	3,016,929.60
SN2F01FCPC	Patch Cord,DLC/PC,DLC/PC,Multi-mode,3m,A1a.2,2mm,42mm DLC,OM3 bending insensitive	1	32	50.00	1,600.00	0.0%	1,600.00
SFP28-AOC-010	Active Optical Cable Assembly,SFP28 AOC,25.78125G,0.01km	1	32	2,190.00	70,080.00	0.0%	70,080.00
LIC-53X0-BS	Basic Software License (Including DeviceManager,SmartThin,SmartMulti-Tenant,SmartMigration,SmartErase,SmartMotion,SystemReporter,eService,SmartQuota,NFS,CIFS,NDMP)	1	1	67,670.00	67,670.00	73.5%	17,932.55
LIC-53X0-ULTRAPATH	OceanStor UltraPath Software License	1	1	67,670.00	67,670.00	73.5%	17,932.55
Hardware & Software Subtotal							4,850,476.15
Support & Maintenance							
02352SCG_88136S CH-242_36	5310 V5(2U,Dual Ctrl,SAS,AC)240V HVDC,256GB Cache,8*1Gb ETH,8*10Gb ETH,4*(4*12Gb) SAS,25*2.5",SPE35C0225)_Hi-Care Onsite Premier OceanStor 5310 V5 Controller Enclosure_36Month(s)	1	4	15,457.50	61,830.00	0.0%	61,830.00
02352WEQ_88136S CH-129_36	1.92TB SSD SAS Disk Unit(2.5")_Hi-Care Onsite Premier OceanStor 1.92TB SSD_36Month(s)	1	48	328.50	15,768.00	0.0%	15,768.00
88035TBJ_88134U GC-OMA_36	Basic Software License (Including DeviceManager,SmartThin,SmartMulti-Tenant,SmartMigration,SmartErase,SmartMotion,SystemReporter,eService,SmartQuota,NFS,CIFS,NDMP)_Hi-Care Application Software Upgrade Support Service OceanStor 5310 V5 Basic Software License_36Month(s)	1	1	14,211.00	14,211.00	0.0%	14,211.00
88035TDQ_88134U GC-ON2_36	OceanStor UltraPath Software License_Hi-Care Application Software Upgrade Support Service OceanStor 5310 V5 OceanStor UltraPath Software License_36Month(s)	1	1	17,256.00	17,256.00	0.0%	17,256.00
8812153243	OceanStor 5310 V5 OceanStor 5300 Series Enterprise Storage Hardware Installation Service	1	1	27,929.72	27,929.72	0.0%	27,929.72
Support & Maintenance Subtotal							136,994.72
SPC-1 Total System Price							4,987,470.87
SPC-1 IOPS™							1,600,658
SPC-1 Price-Performance™ (¥/SPC-1 KIOPS™)							3,115.89
SPC-1 ASU Capacity (GB)							38,225
SPC-1 ASU Price (¥/GB)							130.48

Pricing Details: All prices are in CNY and reflect prices generally available in China.

Discount Details: The discounts shown are based on the storage capacity purchased and are generally available.

Warranty: Hi-Care Premier On-Site Service include: 7*24 Technical Assistance Center Access. Access to all new software updates and Online Support. 24*7*4 Hours Onsite Hardware Replacement.

Availability Date: March 10, 2020.

Response Time and Throughput Graph

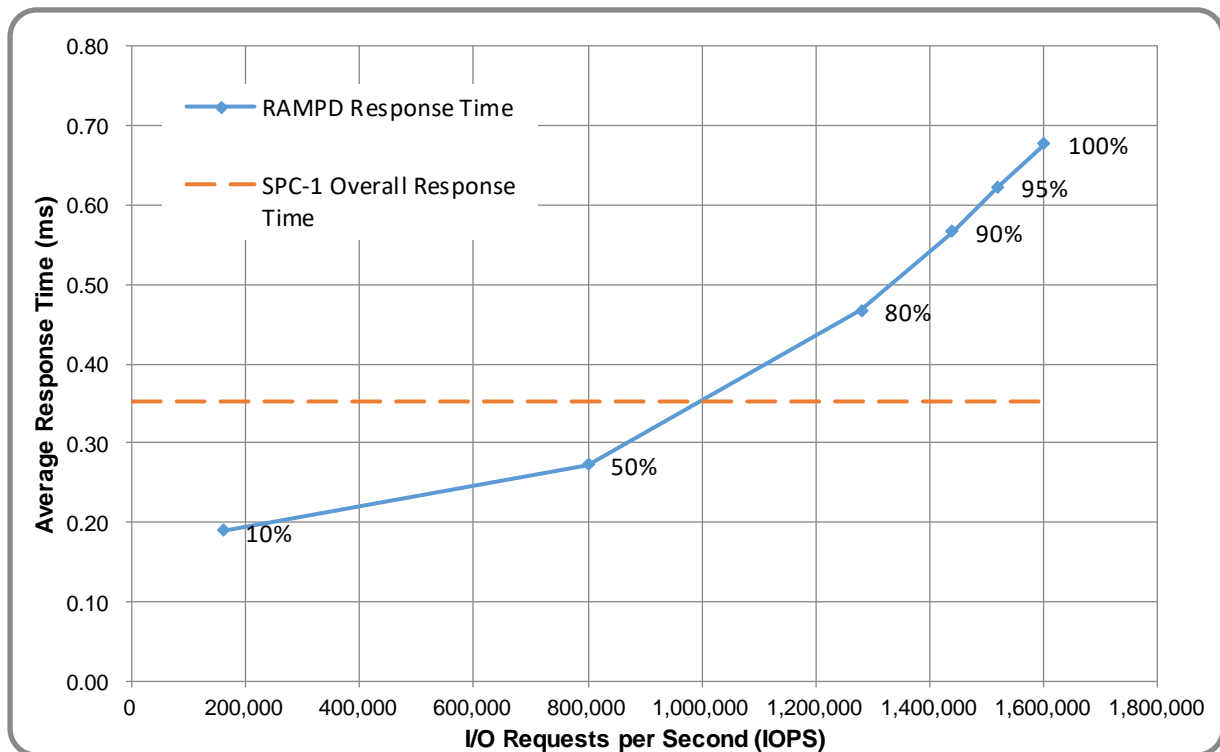

Contact Information	
Test Sponsor Primary Contact	Huawei Technologies Co., Ltd. – www.huawei.com LiFei lu – luolifei@huawei.com
SPC Auditor	InfoSizing – www.sizing.com Doug Johnson – doug@sizing.com

Revision Information	
SPC Benchmark 1™ Revision	V3.8.0
SPC-1 Workload Generator Revision	v3.0.2-1-g823a
Publication Revision History	Initial Publication

CONFIGURATION INFORMATION

Benchmark Configuration and Tested Storage Configuration

The following diagram illustrates the Benchmark Configuration (BC), including the Tested Storage Configuration (TSC) and the Host System(s).

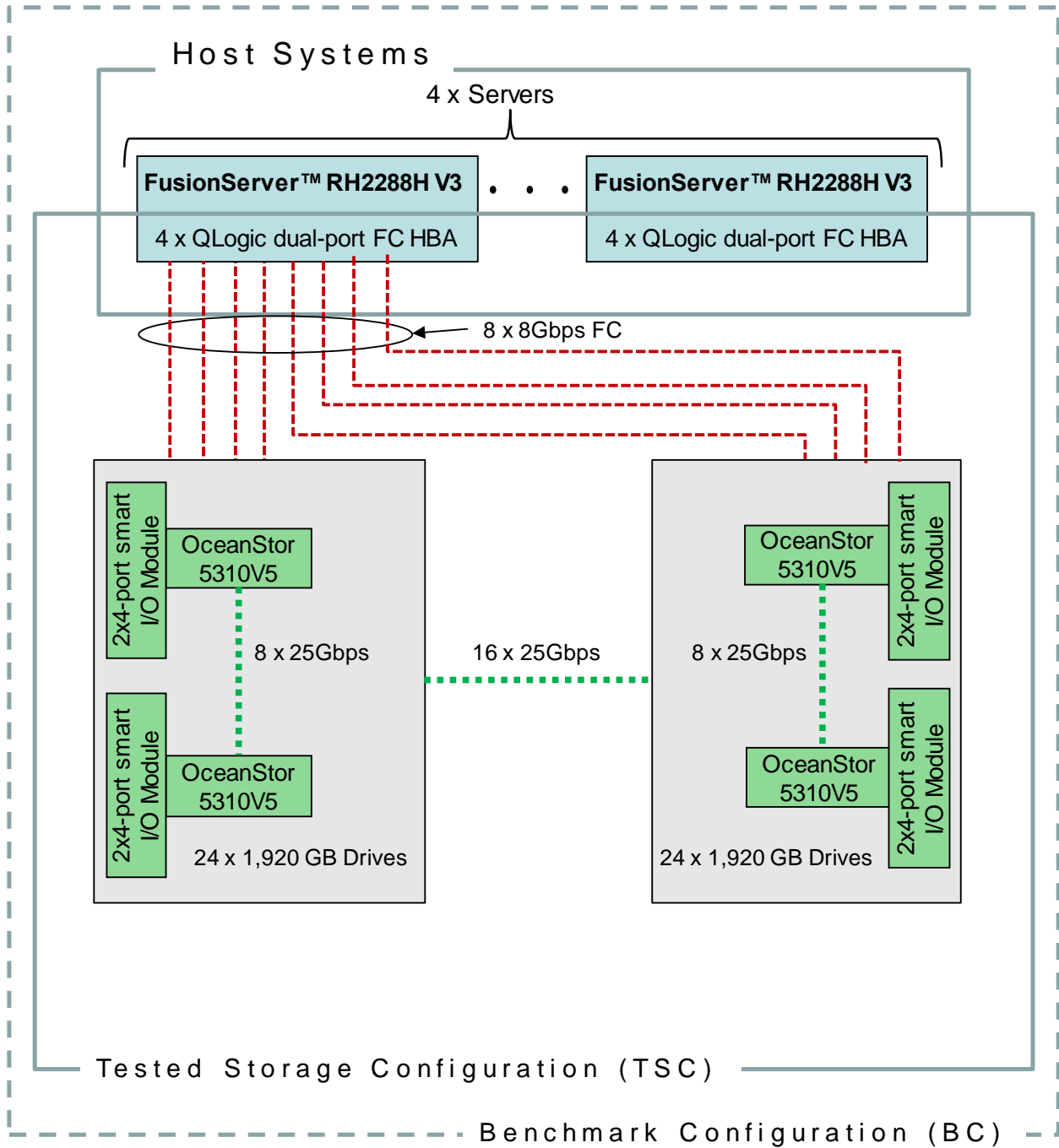

Storage Network Configuration

The Test Storage Configuration (TSC) utilized an external storage subsystem made of 8 Huawei OceanStor 5310 V5, driven by 4 host systems (FusionServer RH2288H V3). Each FusionServer host system connected one-to-one to each OceanStor controller via 8 Gbps FC.

Host System and Tested Storage Configuration Components

The following table lists the components of the Host System(s) and the TSC.

Host Systems
4 x Huawei FusionServer RH2288H V3 2 x Intel® Xeon® CPU E5-2680 v3 (2.50 GHz, 12 Core, 30 MB L3) 128 GB Main Memory Red Hat Enterprise Linux Server Release 7.3 Huawei OceanStor UltraPath software
Tested Storage Configuration
16 x QLogic dual-ported QLE2562 8 Gbps FC HBAs 8 x OceanStor 5310 V5 Active-Active Controllers, each with: 128 GB cache (1,024 GB total) 8 x 4-port 8 Gbps Smart I/O Modules (1 per controller) 16 x 4-port 25 GB Smart I/O Modules (2 per controller) 48 x 1,920 GB SSD Storage Devices (12 per enclosure)
4 x System/Disk Enclosures

Differences Between Tested and Priced Storage Configurations

There were no differences between the TSC and the Priced Storage Configuration.

Component Changes in Revised Full Disclosure Report

The following table outlines component changes that were made in revisions to this Full Disclosure Report.

Original Component	Revised Component	Description of Change
n/a	n/a	Initial submission

Benchmark Configuration Creation Process

Customer Tuning Parameters and Options

All the customer tuning parameters and options that have been altered from their default values for this benchmark are included in Appendix C and in the Supporting Files (see Appendix A).

Tested Storage Configuration Creation

A detailed description of how the logical representation of the TSC was created is included in Appendix D and in the Supporting Files (see Appendix A).

Tested Storage Configuration Inventory

An inventory of the components in the TSC, as seen by the Benchmark Configuration, is included in Appendix E and in the Supporting Files (see Appendix A).

Workload Generator Storage Configuration

The SPC-1 Workload Generator storage configuration commands and parameters used to invoke the execution of the tests are included in Appendix F and in the Supporting Files (see Appendix A).

Logical Volume Capacity and Application Storage Unit Mapping

The following table details the capacity of the Application Storage Units (ASUs) and how they are mapped to logical volumes (LVs). All capacities are reported in GB.

	LV per ASU	LV Capacity	Used per LV	Total per ASU	% ASU Capacity	Optimized*
ASU-1	18	955.6	955.6	17,201.3	45.0%	No
ASU-2	18	955.6	955.6	17,201.3	45.0%	No
ASU-3	2	1,911.2	1,911.2	3,822.5	10.0%	No
SPC-1 ASU Capacity				38,225	*See Space Optimization Techniques	

Physical Storage Capacity and Utilization

The following table details the Physical Capacity of the storage devices and the Physical Capacity Utilization (percentage of Total Physical Capacity used) in support of hosting the ASUs. All capacities are reported in GB.

Devices	Count	Physical Capacity	Total Capacity
SSD	48	1,920.0	92,160.0
Total Physical Capacity			92,160
Physical Capacity Utilization			41.48%

Data Protection

The data protection level used for all LVs was **Protected 2 (RAID10 and full redundancy)**, which was accomplished by configuring dual controllers, dual power, dual fans and RAID-10 device protection.

BENCHMARK EXECUTION RESULTS

This portion of the Full Disclosure Report documents the results of the various SPC-1 Tests, Test Phases, and Test Runs.

Benchmark Execution Overview

Workload Generator Input Parameters

The SPC-1 Workload Generator commands and input parameters for the Test Phases are presented in the Supporting Files (see Appendix A).

Primary Metrics Test Phases

The benchmark execution consists of the Primary Metrics Test Phases, including the Test Phases SUSTAIN, RAMPD_100 to RAMPD_10, RAMPU_50 to RAMPU_100, RAMP_0, REPEAT_1 and REPEAT_2.

Each Test Phase starts with a transition period followed by a Measurement Interval (MI).

Measurement Intervals by Test Phase Graph

The following graph presents the average IOPS and the average Response Times measured over the MI of each Test Phase.

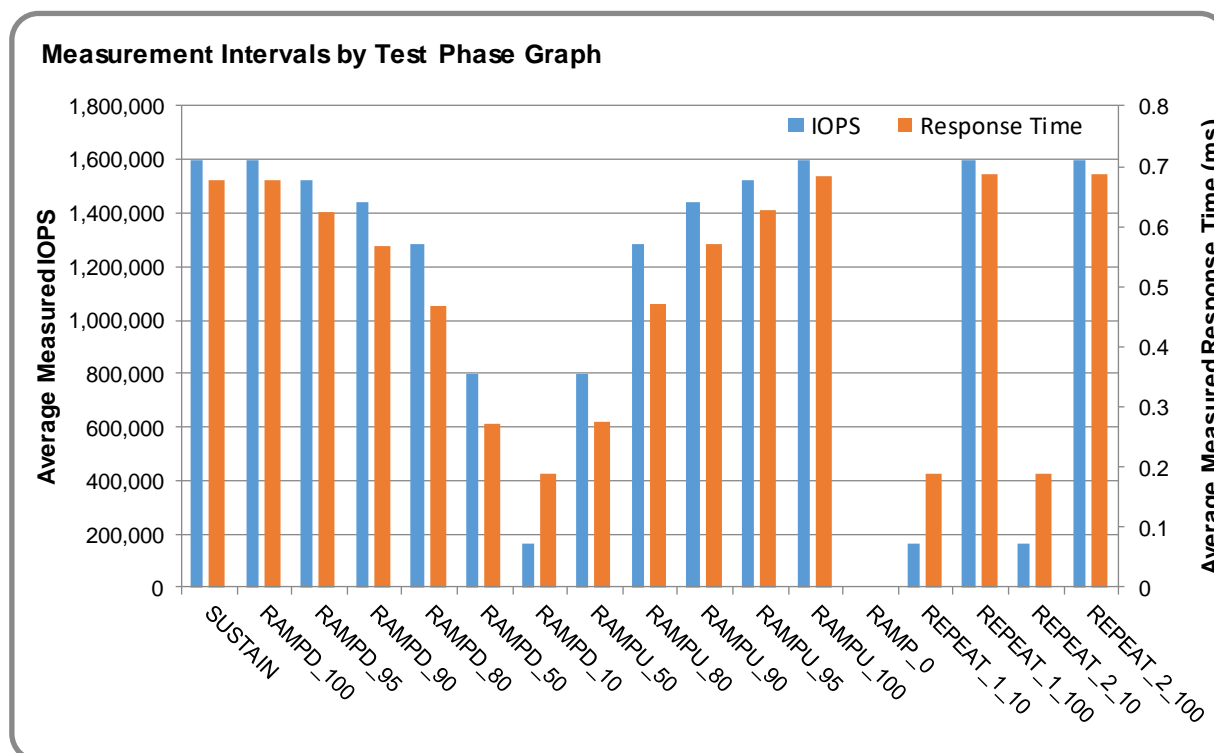

Exception and Waiver

None.

SUSTAIN Test Phase

SUSTAIN – Results File

The results file generated during the execution of the SUSTAIN Test Phase is included in the Supporting Files (see Appendix A) as follows:

- SPC1_METRICS_0_Raw_Results.xlsx

SUSTAIN – Execution Times

Interval	Start Date & Time	End Date & Time	Duration
Transition Period	13-Mar-20 16:59:27	13-Mar-20 18:39:27	1:40:00
Measurement Interval	13-Mar-20 18:39:27	14-Mar-20 02:39:27	8:00:00

SUSTAIN – Throughput Graph

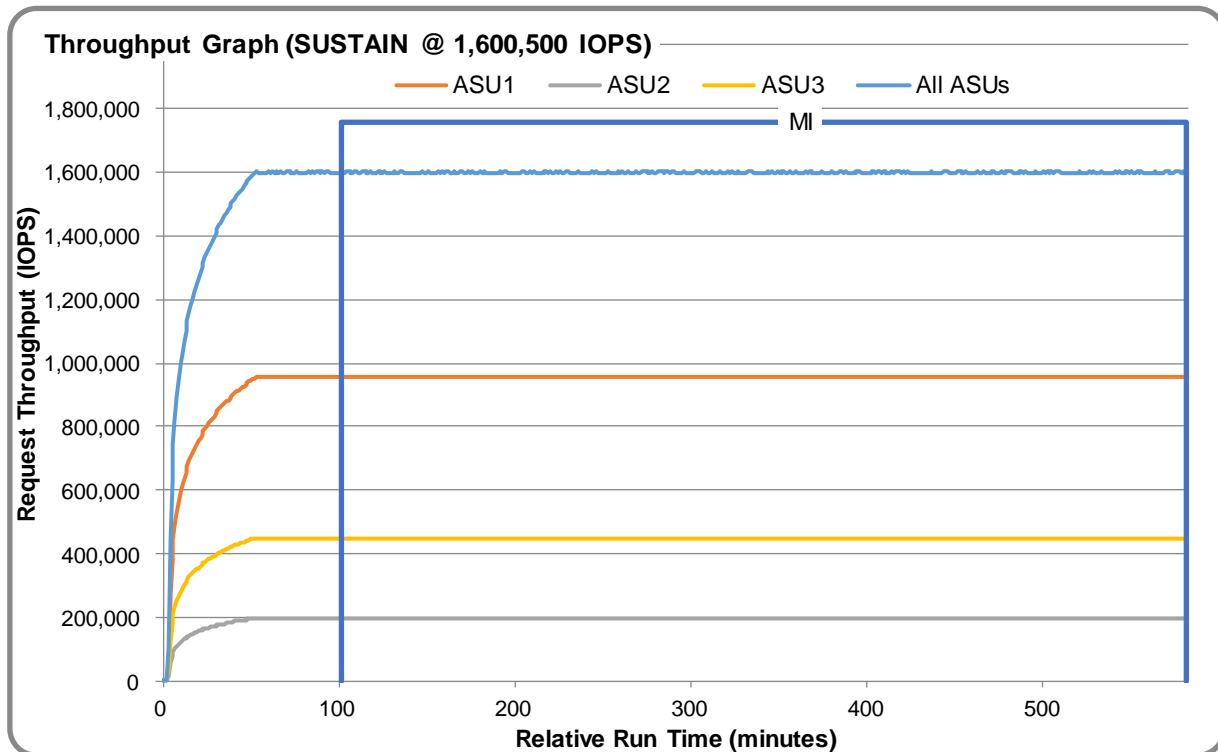

SUSTAIN – Response Time Graph

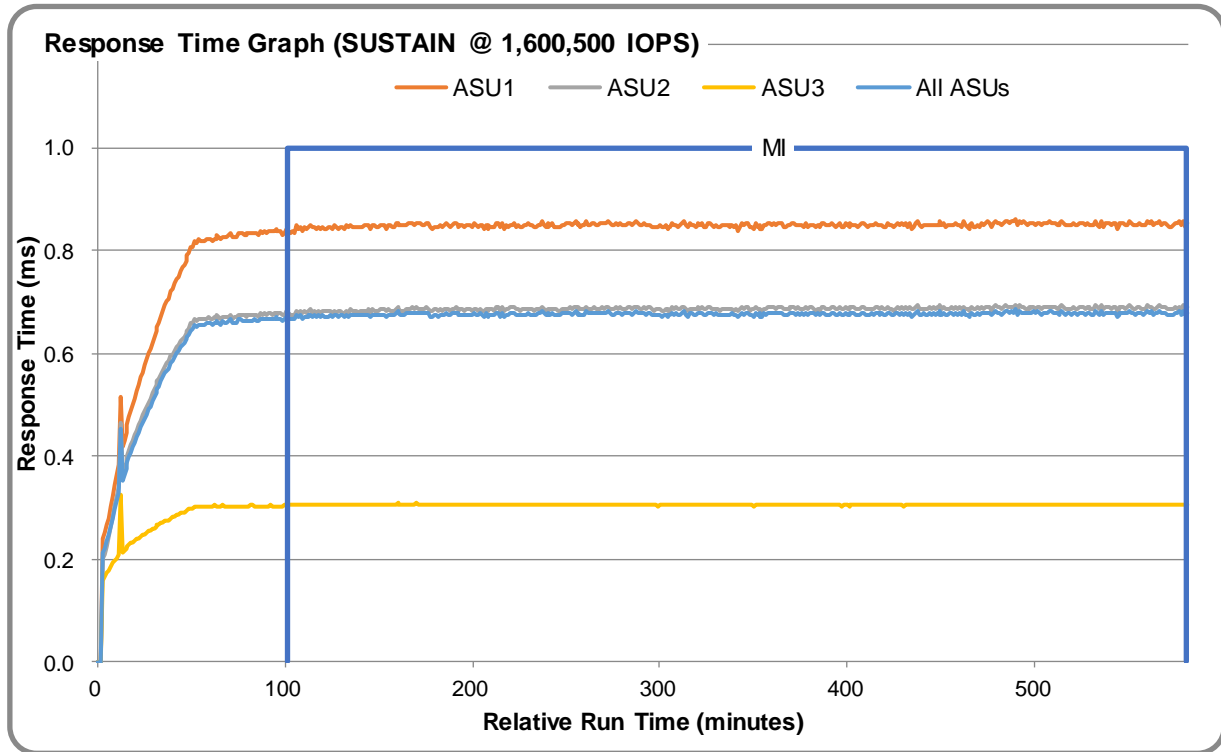

SUSTAIN – Data Rate Graph

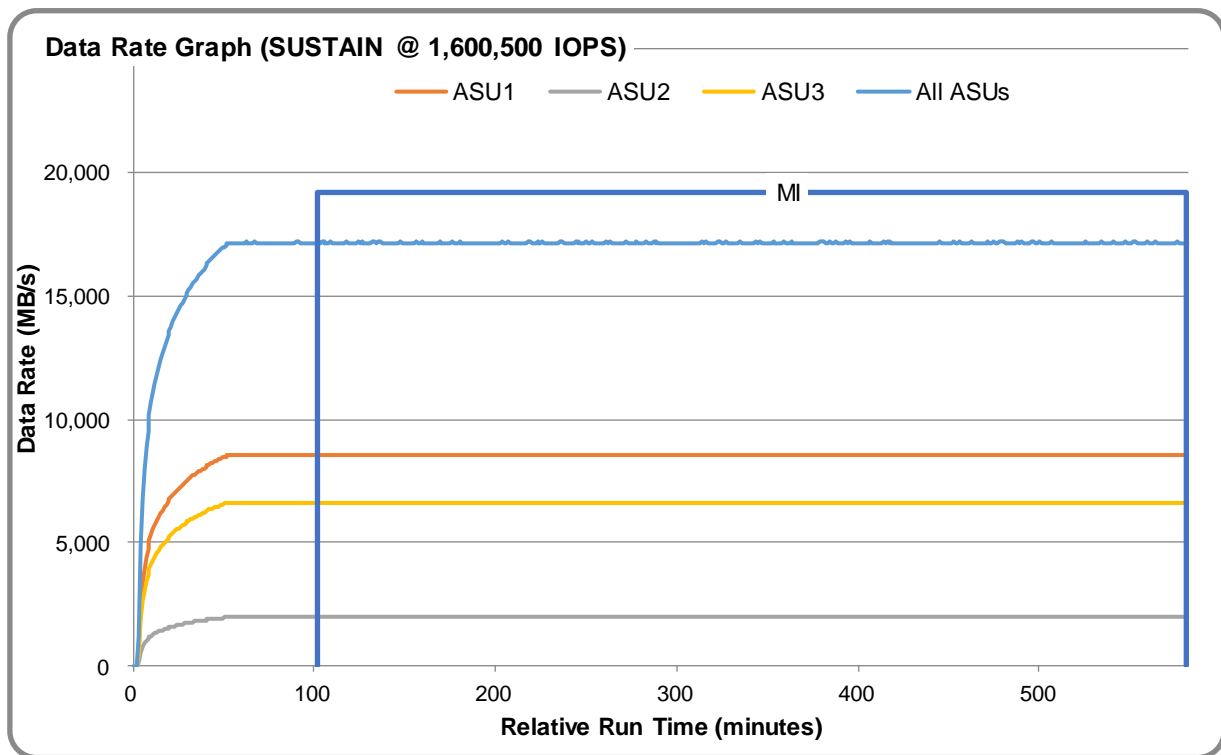

SUSTAIN – Response Time Frequency Graph

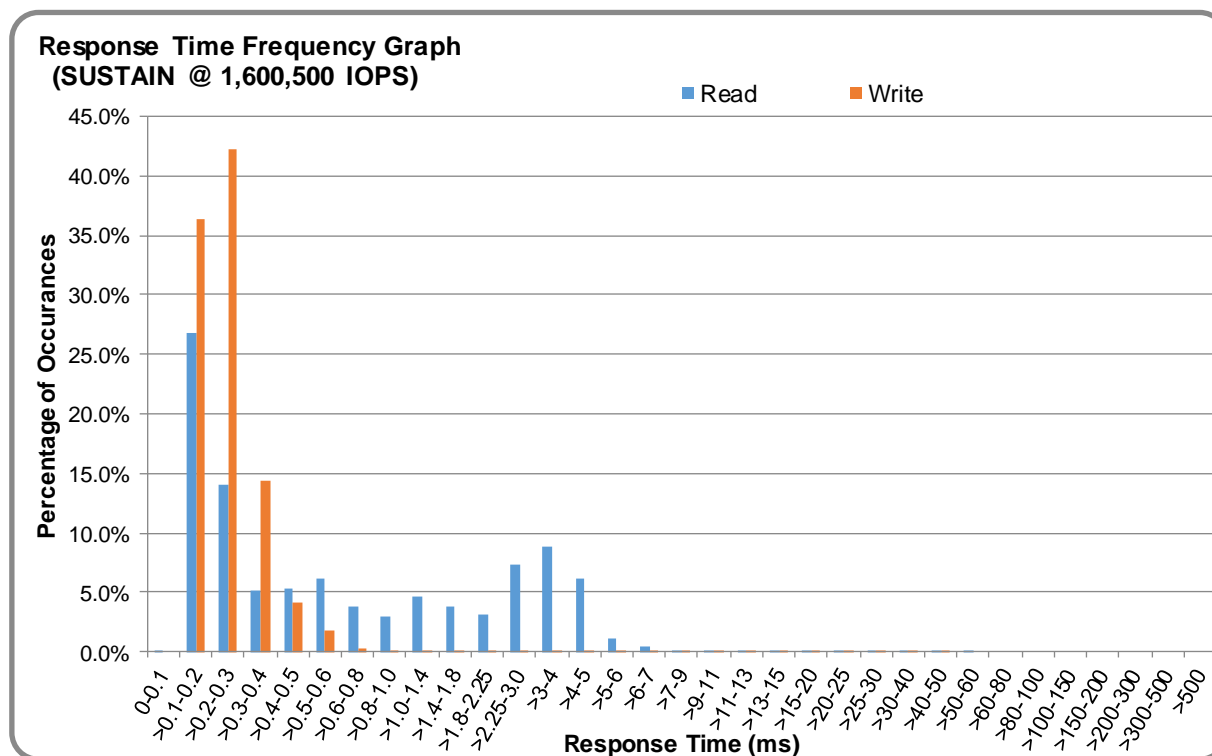

SUSTAIN – Intensity Multiplier

The following table lists the targeted intensity multiplier (Defined), the measured intensity multiplier (Measured) for each I/O stream, its coefficient of variation (Variation), and the percentage of difference (Difference) between Defined and Measured.

	ASU1-1	ASU1-2	ASU1-3	ASU1-4	ASU2-1	ASU2-2	ASU2-3	ASU3-1
Defined	0.0350	0.2810	0.0700	0.2100	0.0180	0.0700	0.0350	0.2810
Measured	0.0350	0.2810	0.0700	0.2100	0.0180	0.0700	0.0350	0.2810
Variation	0.0005	0.0002	0.0004	0.0002	0.0008	0.0004	0.0005	0.0002
Difference	0.003%	0.001%	0.003%	0.000%	0.007%	0.003%	0.004%	0.002%

RAMPD_100 Test Phase

RAMPD 100 – Results File

The results file generated during the execution of the RAMPD_100 Test Phase is included in the Supporting Files (see Appendix A) as follows:

- SPC1_METRICS_0_Raw_Results.xlsx

RAMPD 100 – Execution Times

Interval	Start Date & Time	End Date & Time	Duration
Transition Period	14-Mar-20 02:40:28	14-Mar-20 02:43:28	0:03:00
Measurement Interval	14-Mar-20 02:43:28	14-Mar-20 02:53:28	0:10:00

RAMPD 100 – Throughput Graph

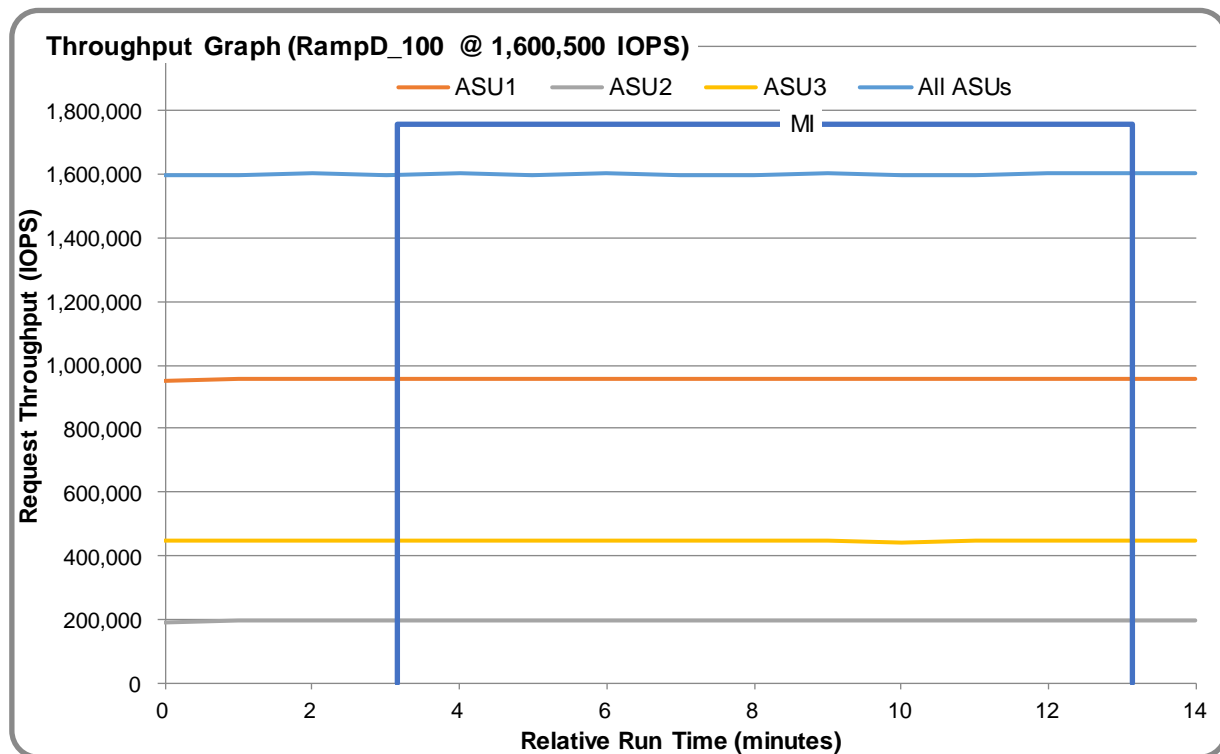

RAMPD 100 – Response Time Graph

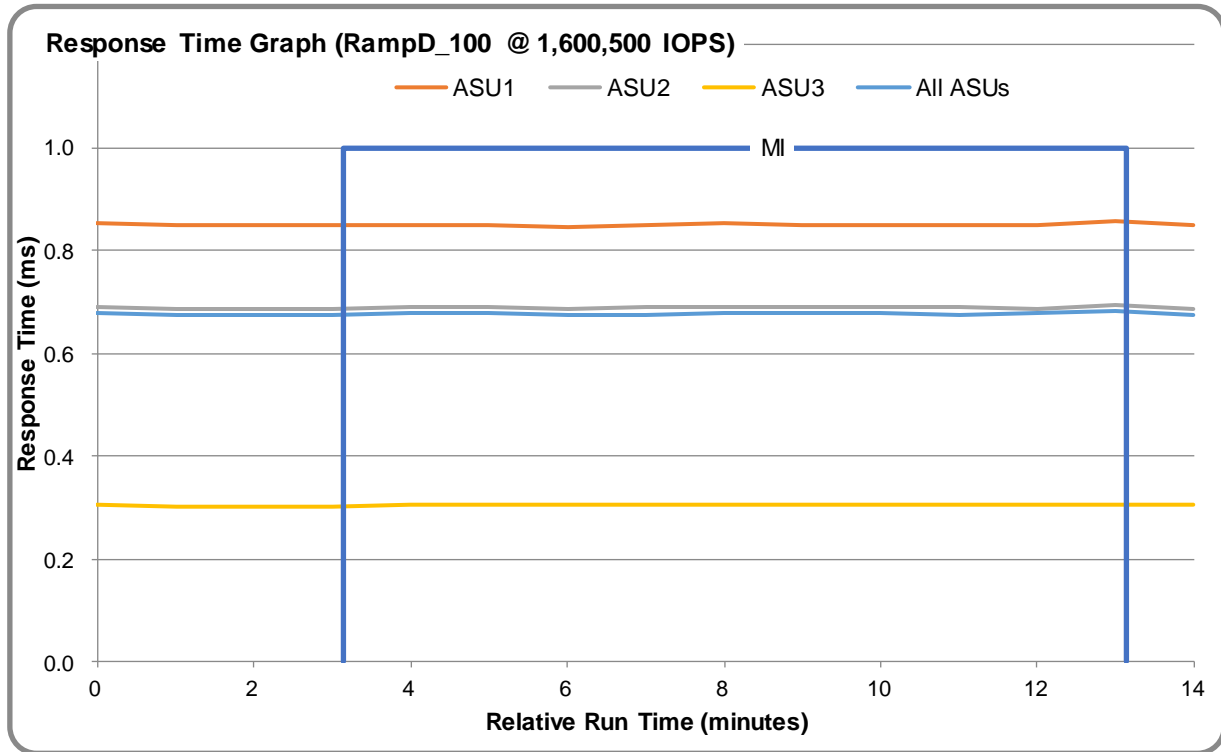

RAMPD 100 – Data Rate Graph

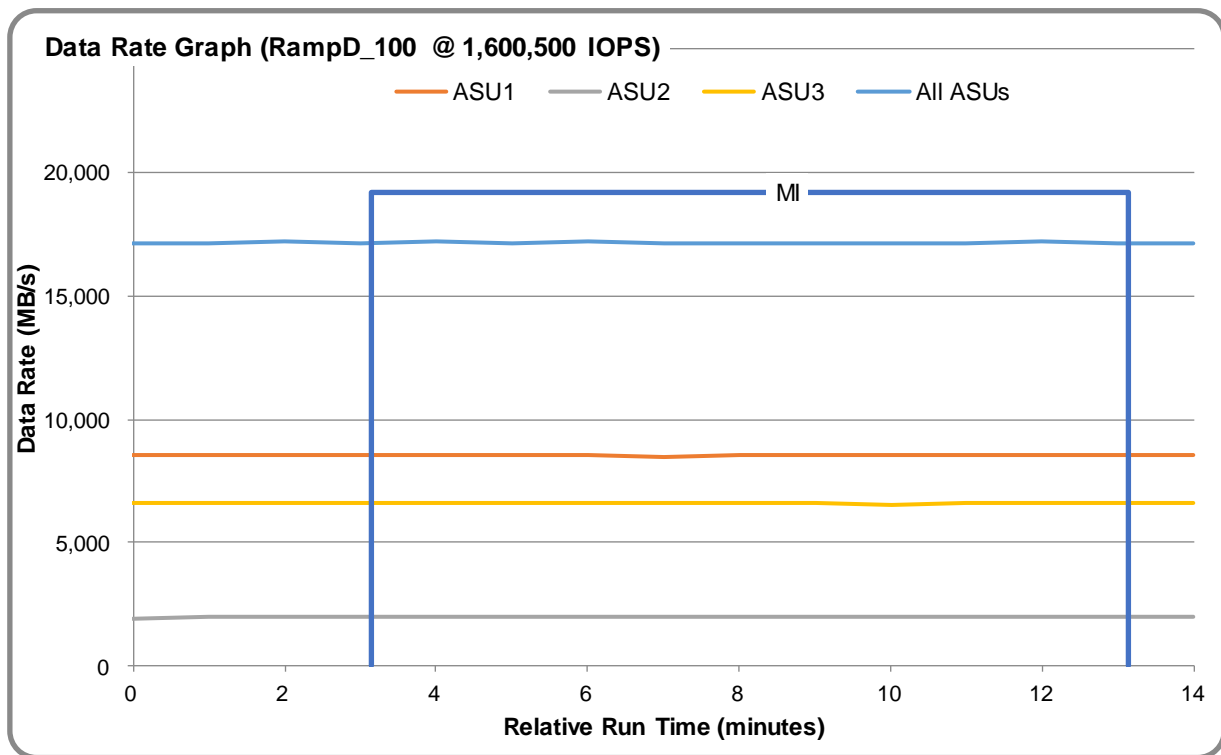

RAMPD 100 – Response Time Frequency Graph

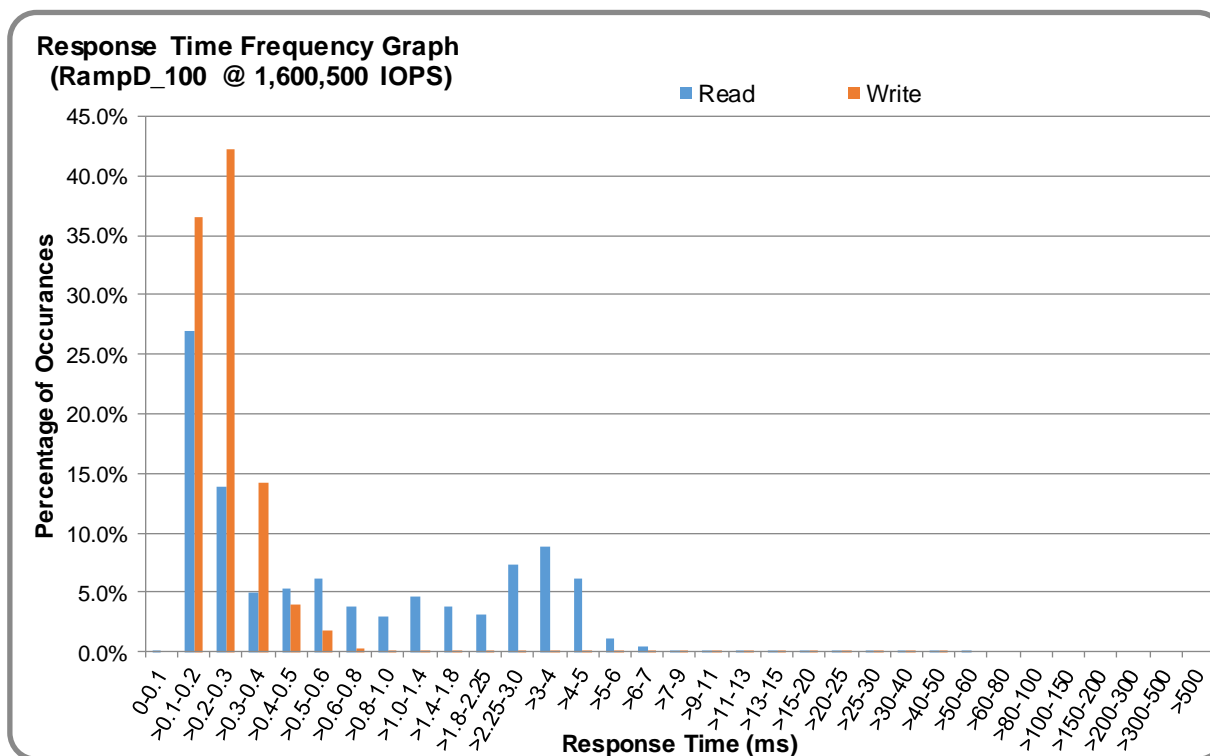

RAMPD 100 – Intensity Multiplier

The following table lists the targeted intensity multiplier (Defined), the measured intensity multiplier (Measured) for each I/O stream, its coefficient of variation (Variation), and the percentage of difference (Difference) between Defined and Measured.

	ASU1-1	ASU1-2	ASU1-3	ASU1-4	ASU2-1	ASU2-2	ASU2-3	ASU3-1
Defined	0.0350	0.2810	0.0700	0.2100	0.0180	0.0700	0.0350	0.2810
Measured	0.0350	0.2810	0.0700	0.2100	0.0180	0.0700	0.0350	0.2810
Variation	0.0006	0.0002	0.0004	0.0002	0.0006	0.0003	0.0005	0.0002
Difference	0.009%	0.003%	0.019%	0.009%	0.048%	0.007%	0.013%	0.000%

RAMPD 100 – I/O Request Summary

I/O Requests Completed in the Measurement Interval	960,383,036
I/O Requests Completed with Response Time <= 30 ms	960,377,076
I/O Requests Completed with Response Time > 30 ms	5,960

Response Time Ramp Test

Response Time Ramp Test – Results File

The results file generated during the execution of the Response Time Ramp Test is included in the Supporting Files (see Appendix A) as follows:

- **SPC1_METRICS_0_Raw_Results.xlsx**

Response Time Ramp Test – Phases

The Response Time Ramp Test is comprised of 11 Test Phases, including six Ramp-Down Phases (executed at 100%, 95%, 90%, 80%, 50%, and 10% of the Business Scaling Unit) and five Ramp-Up Phases (executed at 50%, 80%, 90%, 95%, and 100% of the Business Scaling Unit).

Response Time Ramp Test – Average Throughput Graph

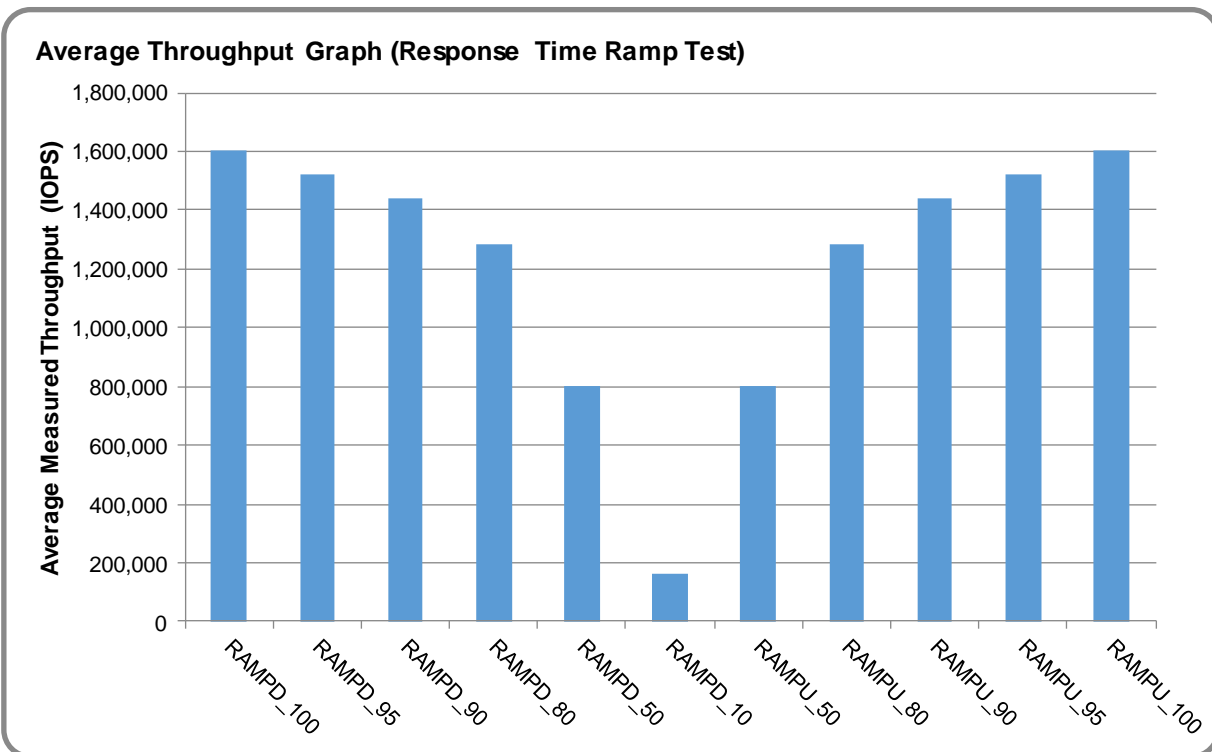

Response Time Ramp Test – Average Response Time Graph

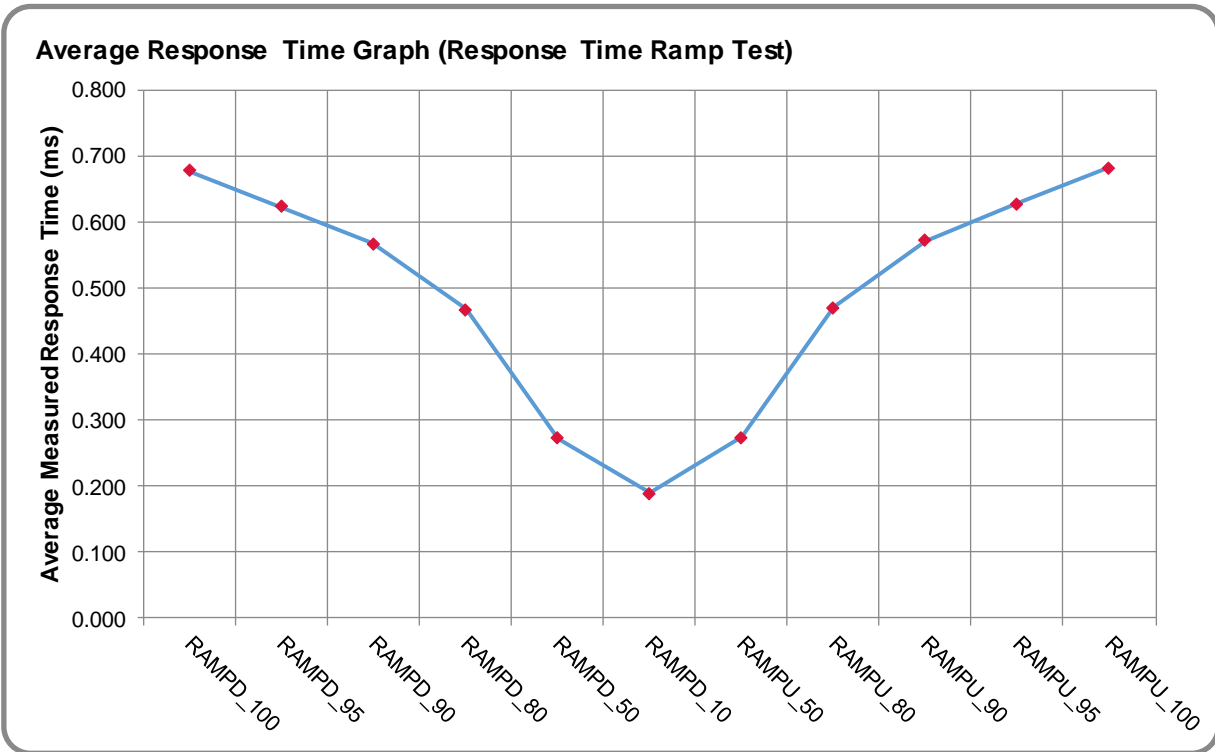

Response Time Ramp Test – RAMPD 10 Response Time Graph

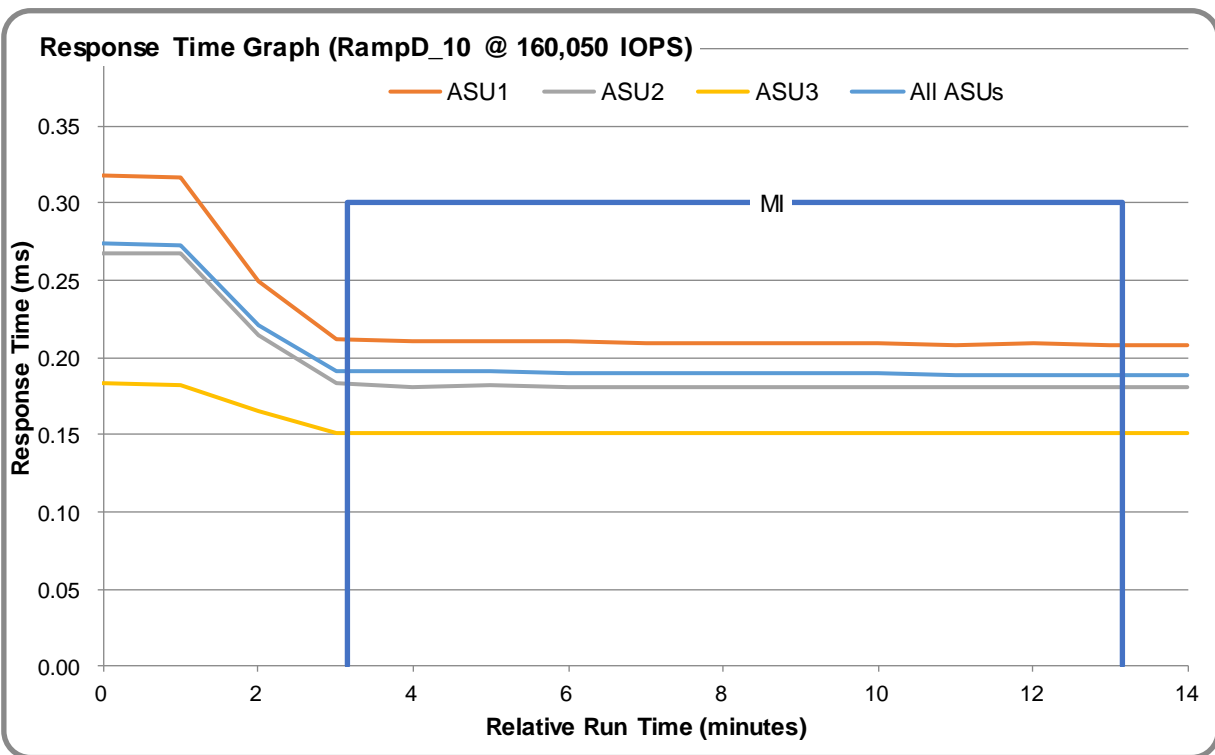

Repeatability Test

Repeatability Test Results File

The results file generated during the execution of the Repeatability Test is included in the Supporting Files (see Appendix A) as follows:

- **SPC1_METRICS_0_Raw_Results.xlsx**

Repeatability Test Results

The throughput measurements for the Response Time Ramp Test (RAMPD) and the Repeatability Test Phases (REPEAT_1 and REPEAT_2) are listed in the table below.

Test Phase	100% IOPS	10% IOPS
RAMPD	1,600,658.3	160,065.7
REPEAT_1	1,600,617.3	160,094.3
REPEAT_2	1,600,521.5	160,071.8

REPEAT 1 100 - Throughput Graph

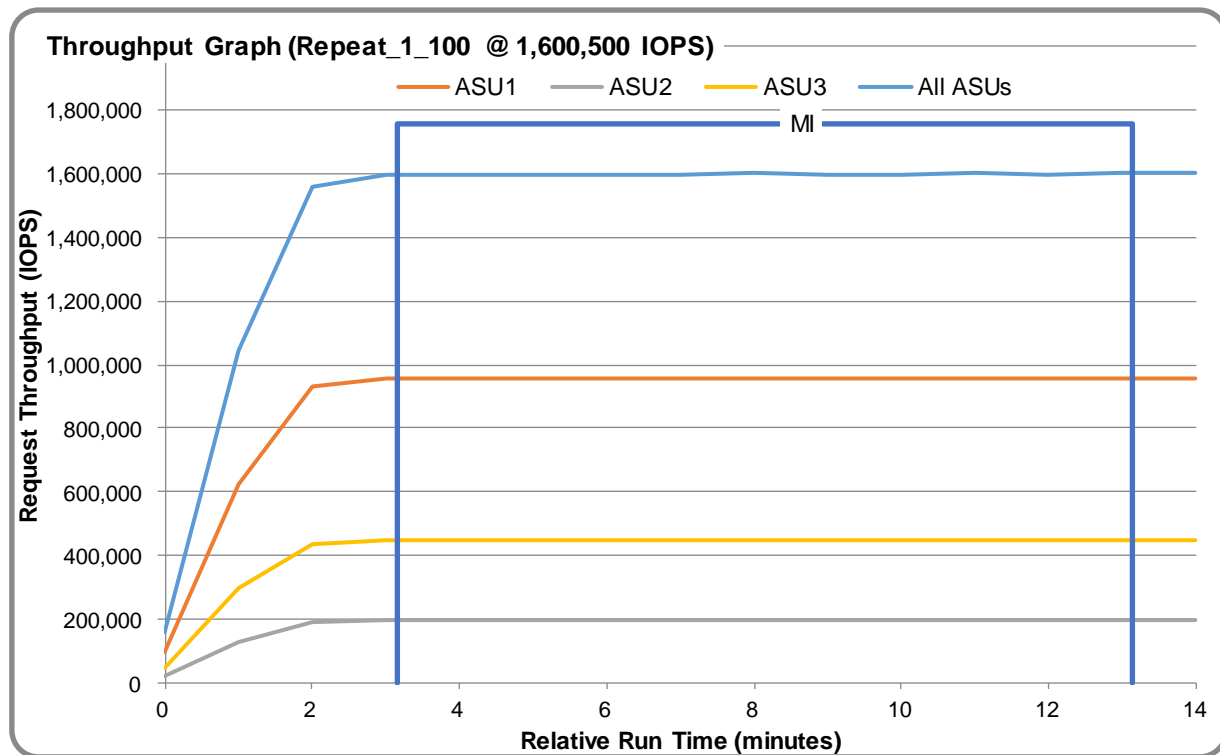

REPEAT 1 100 – Response Time Graph

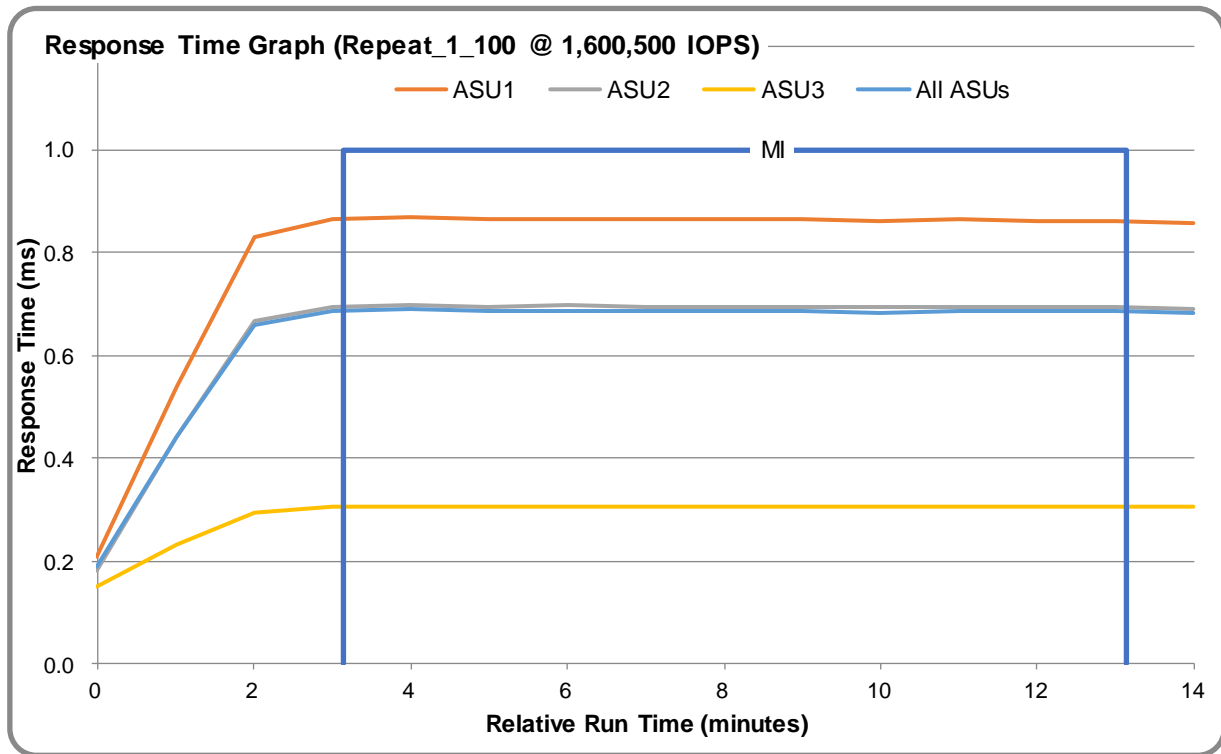

REPEAT 2 100 – Throughput Graph

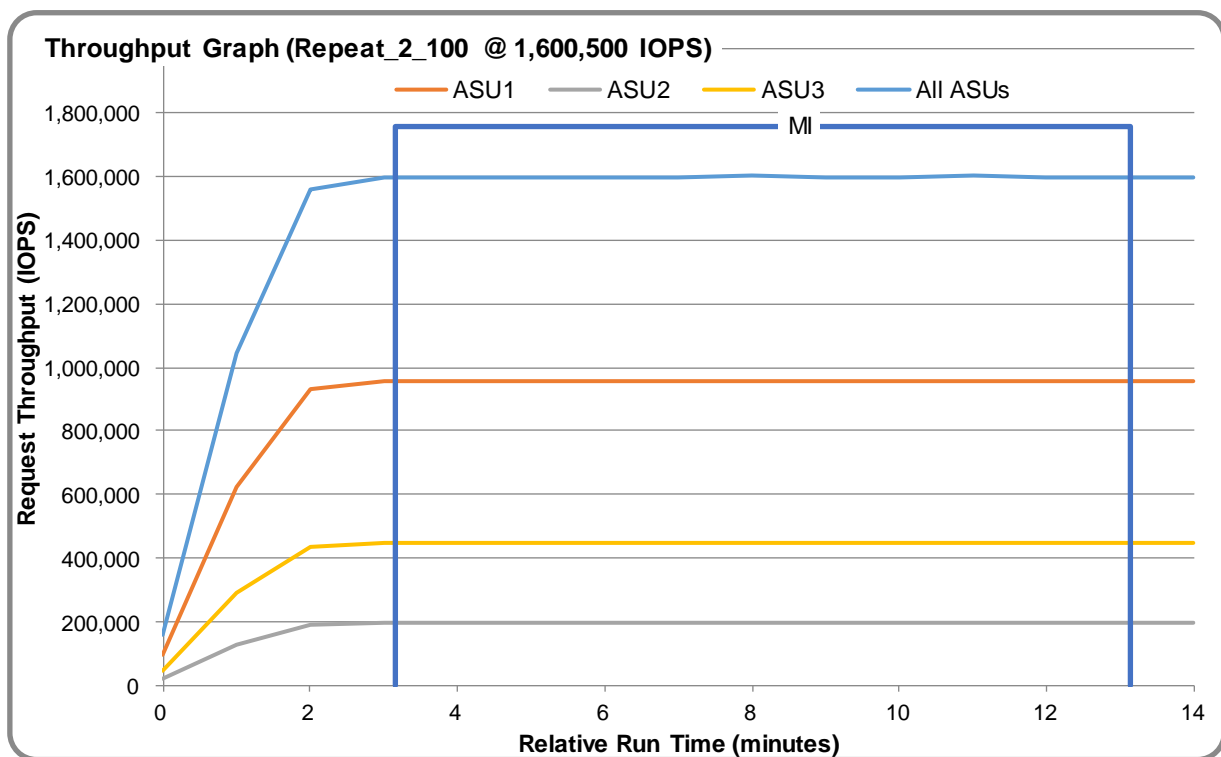

REPEAT 2 100 – Response Time Graph

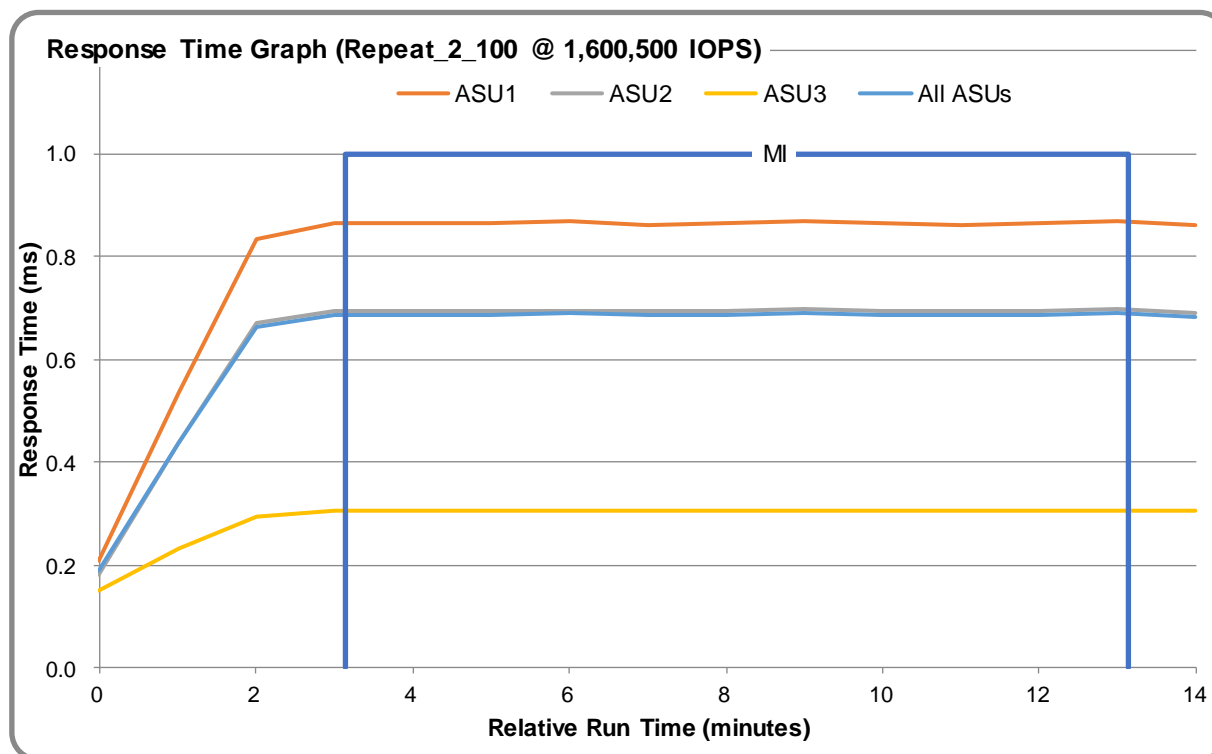

Repeatability Test – Intensity Multiplier

The following tables lists the targeted intensity multiplier (Defined), the measured intensity multiplier (Measured) for each I/O stream, its coefficient of variation (Variation), and the percent of difference (Difference) between Defined and Measured.

REPEAT_1_100 Test Phase

	ASU1-1	ASU1-2	ASU1-3	ASU1-4	ASU2-1	ASU2-2	ASU2-3	ASU3-1
Defined	0.0350	0.2810	0.0700	0.2100	0.0180	0.0700	0.0350	0.2810
Measured	0.0350	0.2810	0.0700	0.2100	0.0180	0.0700	0.0350	0.2810
Variation	0.0006	0.0002	0.0003	0.0002	0.0008	0.0005	0.0005	0.0002
Difference	0.010%	0.001%	0.010%	0.005%	0.020%	0.002%	0.015%	0.003%

REPEAT_2_100 Test Phase

	ASU1-1	ASU1-2	ASU1-3	ASU1-4	ASU2-1	ASU2-2	ASU2-3	ASU3-1
Defined	0.0350	0.2810	0.0700	0.2100	0.0180	0.0700	0.0350	0.2810
Measured	0.0350	0.2810	0.0700	0.2100	0.0180	0.0700	0.0350	0.2810
Variation	0.0005	0.0002	0.0005	0.0002	0.0006	0.0003	0.0004	0.0001
Difference	0.030%	0.000%	0.019%	0.008%	0.024%	0.009%	0.012%	0.005%

Space Optimization Techniques

Description of Utilized Techniques

The TSC did not use any space optimization techniques.

Physical Free Space Metrics

The following table lists the Physical Free Space as measured at each of the required points during test execution. If space optimization techniques were not used, "NA" is reported.

Physical Free Space Measurement	Free Space (GB)
After Logical Volume Creation	NA
After ASU Pre-Fill	NA
After Repeatability Test Phase	NA

Space Optimization Metrics

The following table lists the required space optimization metrics. If space optimization techniques were not used, "NA" is reported.

Metric	Value
SPC-1 Space Optimization Ratio	NA
SPC-1 Space Effectiveness Ratio	NA

Data Persistence Test

Data Persistence Test Results File

The results files generated during the execution of the Data Persistence Test is included in the Supporting Files (see Appendix A) as follows:

- **SPC1_PERSIST_1_0_Raw_Results.xlsx**
- **SPC1_PERSIST_2_0_Raw_Results.xlsx**

Data Persistence Test Execution

The Data Persistence Test was executed using the following sequence of steps:

- The PERSIST_1_0 Test Phase was executed to completion.
- The Benchmark Configuration was taken through an orderly shutdown process and powered off.
- The Benchmark Configuration was powered on and taken through an orderly startup process.
- The PERSIST_2_0 Test Phase was executed to completion.

Data Persistence Test Results

Data Persistence Test Phase: Persist1	
Total Number of Logical Blocks Written	328,877,441
Total Number of Logical Blocks Verified	165,943,029
Total Number of Logical Blocks Overwritten	162,934,412
Total Number of Logical Blocks that Failed Verification	0
Time Duration for Writing Test Logical Blocks (sec.)	600
Size in bytes of each Logical Block	8,192
Number of Failed I/O Requests in the process of the Test	0

Committed Data Persistence Implementation

Committed data persistence is implemented at two levels. At the drive level, data loss is prevented through the use of RAID-10 arrays. At the controller level, all caches are mirrored across controllers, where write requests are only completed once the local cache has been successfully mirrored in another controller's cache. In addition, cache content is protected from a loss of power by flushing the cache content to permanent flash memory as soon as a power loss is detected. The flushing action is powered by a battery backup located in each controller.

APPENDIX A: SUPPORTING FILES

The following table details the content of the Supporting Files provided as part of this Full Disclosure Report.

File Name	Description	Location
/SPC1_RESULTS	Data reduction worksheets	root
SPC1_INIT_0_Raw_Results.xlsx	Raw results for INIT Test Phase	/SPC1_RESULTS
SPC1_METRICS_0_Quick_Look.xlsx	Quick Look Test Run Overview	/SPC1_RESULTS
SPC1_METRICS_0_Raw_Results.xlsx	Raw results for Primary Metrics Test	/SPC1_RESULTS
SPC1_METRICS_0_Summary_Results.xlsx	Primary Metrics Summary	/SPC1_RESULTS
SPC1_PERSIST_1_0_Raw_Results.xlsx	Raw results for PERSIST1 Test Phase	/SPC1_RESULTS
SPC1_PERSIST_2_0_Raw_Results.xlsx	Raw results for PERSIST2 Test Phase	/SPC1_RESULTS
SPC1_Run_Set_Overview.xlsx	Run Set Overview Worksheet	/SPC1_RESULTS
SPC1_VERIFY_0_Raw_Results.xlsx	Raw results for first VERIFY Test Phase	/SPC1_RESULTS
SPC1_VERIFY_1_Raw_Results.xlsx	Raw results for second VERIFY Test Phase	/SPC1_RESULTS
/C_Tuning	Tuning parameters and options	root
aio-max-nr.sh	Set maximum asynchronous I/O	/C_Tuning
nr_requests.sh	Increase disk queue depth	/C_Tuning
scheduler.sh	Change the I/O scheduler	/C_Tuning
/D_Creation	Storage configuration creation	root
mklun.txt	Create the storage environment	/D_Creation
mkvolume.txt	Create the logical volumes	/D_Creation
/E_Inventory	Configuration inventory	root
profile1_storage.log	List of storage devices before INIT	/E_Inventory
profile1_volume.log	List of logical volumes before INIT	/E_Inventory
profile2_storage.log	List of storage devices after restart	/E_Inventory
profile2_volume.log	List of logical volumes after restart	/E_Inventory
/F_Generator	Workload generator	root
4host.HST	Host configuration file	/F_generator
full_run.sh	Execute all test phases	/F_generator
slave_asu.asu	Define LUNs hosting the ASUs	/F_generator

APPENDIX B: THIRD PARTY QUOTATION

All components are available directly through the Test Sponsor (Huawei Technologies Co., Ltd.).

APPENDIX C: TUNING PARAMETERS AND OPTIONS

The following scripts were used to set the tuning parameters and options.

- aio-max-nr.sh – set the maximum number of AIO operations to 10485760
- nr_requests.sh – set nr_requests to 4096 for each device
- scheduler.sh – set the I/O scheduler to noop for each device

Details are available in the Supporting Files (see Appendix A).

APPENDIX D: STORAGE CONFIGURATION CREATION

The scripts referenced in Steps 2 and 3 appear in the section, Referenced Scripts.

Step 1: Create Disk Domains, Storage Pools, LUNs, LUN Group

mklun.txt is a script including all the CLI commands to create disk domains, storage pools, LUNs and compression is disabled:

- Create 4 **disk_domain**
- Create 4 **storage_pool**
- Create 32 **lun**
- Create one **lun_group(lg0)**
- Add the 32 LUNs to **lun_group, lg0**

```
create disk_domain name=dd0 disk_list=CTE0.0-11 disk_domain_id=0
create disk_domain name=dd1 disk_list=CTE1.0-11 disk_domain_id=1
create disk_domain name=dd2 disk_list=CTE2.0-11 disk_domain_id=2
create disk_domain name=dd3 disk_list=CTE3.0-11 disk_domain_id=3
```

```
create storage_pool name=pool0 disk_type=SSD capacity=9445GB pool_id=0 raid_level=RAID10 disk_domain_id=0
stripe_depth=64KB
```

```
create storage_pool name=pool1 disk_type=SSD capacity=9445GB pool_id=1 raid_level=RAID10 disk_domain_id=1
stripe_depth=64KB
```

```
create storage_pool name=pool2 disk_type=SSD capacity=9445GB pool_id=2 raid_level=RAID10 disk_domain_id=2
stripe_depth=64KB
```

```
create storage_pool name=pool3 disk_type=SSD capacity=9445GB pool_id=3 raid_level=RAID10 disk_domain_id=3
stripe_depth=64KB
```

```
create lun name=lun1 pool_id=0 capacity=1180GB owner_controller=0A lun_id=1 lun_type=thick
create lun name=lun2 pool_id=0 capacity=1180GB owner_controller=0A lun_id=5 lun_type=thick
create lun name=lun3 pool_id=0 capacity=1180GB owner_controller=0A lun_id=9 lun_type=thick
create lun name=lun4 pool_id=0 capacity=1180GB owner_controller=0A lun_id=13 lun_type=thick
create lun name=lun5 pool_id=0 capacity=1180GB owner_controller=0B lun_id=2 lun_type=thick
create lun name=lun6 pool_id=0 capacity=1180GB owner_controller=0B lun_id=6 lun_type=thick
create lun name=lun7 pool_id=0 capacity=1180GB owner_controller=0B lun_id=10 lun_type=thick
create lun name=lun8 pool_id=0 capacity=1180GB owner_controller=0B lun_id=14 lun_type=thick
create lun name=lun9 pool_id=1 capacity=1180GB owner_controller=1A lun_id=3 lun_type=thick
create lun name=lun10 pool_id=1 capacity=1180GB owner_controller=1A lun_id=7 lun_type=thick
create lun name=lun11 pool_id=1 capacity=1180GB owner_controller=1A lun_id=11 lun_type=thick
create lun name=lun12 pool_id=1 capacity=1180GB owner_controller=1A lun_id=15 lun_type=thick
create lun name=lun13 pool_id=1 capacity=1180GB owner_controller=1B lun_id=4 lun_type=thick
create lun name=lun14 pool_id=1 capacity=1180GB owner_controller=1B lun_id=8 lun_type=thick
create lun name=lun15 pool_id=1 capacity=1180GB owner_controller=1B lun_id=12 lun_type=thick
create lun name=lun16 pool_id=1 capacity=1180GB owner_controller=1B lun_id=16 lun_type=thick
create lun name=lun17 pool_id=2 capacity=1180GB owner_controller=2A lun_id=17 lun_type=thick
create lun name=lun18 pool_id=2 capacity=1180GB owner_controller=2A lun_id=21 lun_type=thick
create lun name=lun19 pool_id=2 capacity=1180GB owner_controller=2A lun_id=25 lun_type=thick
create lun name=lun20 pool_id=2 capacity=1180GB owner_controller=2A lun_id=29 lun_type=thick
create lun name=lun21 pool_id=2 capacity=1180GB owner_controller=2B lun_id=18 lun_type=thick
```

```
create lun name=lun22 pool_id=2 capacity=1180GB owner_controller=2B lun_id=22 lun_type=thick
create lun name=lun23 pool_id=2 capacity=1180GB owner_controller=2B lun_id=26 lun_type=thick
create lun name=lun24 pool_id=2 capacity=1180GB owner_controller=2B lun_id=30 lun_type=thick
create lun name=lun25 pool_id=3 capacity=1180GB owner_controller=3A lun_id=19 lun_type=thick
create lun name=lun26 pool_id=3 capacity=1180GB owner_controller=3A lun_id=23 lun_type=thick
create lun name=lun27 pool_id=3 capacity=1180GB owner_controller=3A lun_id=27 lun_type=thick
create lun name=lun28 pool_id=3 capacity=1180GB owner_controller=3A lun_id=31 lun_type=thick
create lun name=lun29 pool_id=3 capacity=1180GB owner_controller=3B lun_id=20 lun_type=thick
create lun name=lun30 pool_id=3 capacity=1180GB owner_controller=3B lun_id=24 lun_type=thick
create lun name=lun31 pool_id=3 capacity=1180GB owner_controller=3B lun_id=28 lun_type=thick
create lun name=lun32 pool_id=3 capacity=1180GB owner_controller=3B lun_id=32 lun_type=thick
```

```
create lun_group name=lg lun_group_id=1
add lun_group lun lun_group_id=1 lun_id_list=1-32
```

Step 2: Create Mapping View, Host Group and Host

Execute the following commands using the OceanStor 5310V5 CLI from the Host System to complete the following:

- Create 4 **hosts**
- Create one **host_group (hg)**
- Add 4 **hosts** to **hg**
- Add the FC ports' WWN to 4 **hosts**
- Create one **mapping_view (mv1)**

```
create host name=h1 operating_system=Linux host_id=1
create host name=h2 operating_system=Linux host_id=2
create host name=h3 operating_system=Linux host_id=3
create host name=h4 operating_system=Linux host_id=4
```

```
add host_group host host_group_id=1 host_id_list=1,2,3,4
```

```
add host initiator host_id=1 initiator_type=FC wwn=21000024ff543bdb
add host initiator host_id=1 initiator_type=FC wwn=21000024ff76ce2f
add host initiator host_id=1 initiator_type=FC wwn=21000024ff5c3b09
add host initiator host_id=1 initiator_type=FC wwn=21000024ff2c94ed
add host initiator host_id=1 initiator_type=FC wwn=21000024ff2c94ec
add host initiator host_id=1 initiator_type=FC wwn=21000024ff543bda
add host initiator host_id=1 initiator_type=FC wwn=21000024ff543bda
add host initiator host_id=1 initiator_type=FC wwn=21000024ff5c3b08
```

```
add host initiator host_id=2 initiator_type=FC wwn=21000024ff4b82b0
add host initiator host_id=2 initiator_type=FC wwn=21000024ff4b82b1
add host initiator host_id=2 initiator_type=FC wwn=2101001b322b0a3f
add host initiator host_id=2 initiator_type=FC wwn=2100001b320b0a3f
add host initiator host_id=2 initiator_type=FC wwn=21000024ff28ea5c
add host initiator host_id=2 initiator_type=FC wwn=21000024ff28ea5d
add host initiator host_id=2 initiator_type=FC wwn=21000024ff17e0ba
```

```
add host initiator host_id=2 initiator_type=FC wwn=21000024ff17e0bb

add host initiator host_id=3 initiator_type=FC wwn=2100f4e9d4533747
add host initiator host_id=3 initiator_type=FC wwn=21000024ff369d91
add host initiator host_id=3 initiator_type=FC wwn=21000024ff2f37c3
add host initiator host_id=3 initiator_type=FC wwn=21000024ff3721c5
add host initiator host_id=3 initiator_type=FC wwn=21000024ff2f37c2
add host initiator host_id=3 initiator_type=FC wwn=21000024ff3721c4
add host initiator host_id=3 initiator_type=FC wwn=21000024ff369d90
add host initiator host_id=3 initiator_type=FC wwn=2100f4e9d4533746

add host initiator host_id=4 initiator_type=FC wwn=2100f4e9d4533c14
add host initiator host_id=4 initiator_type=FC wwn=2100f4e9d4533c15
add host initiator host_id=4 initiator_type=FC wwn=21000024ff1bea30
add host initiator host_id=4 initiator_type=FC wwn=21000024ff1bea31
add host initiator host_id=4 initiator_type=FC wwn=21000024ff8f05ee
add host initiator host_id=4 initiator_type=FC wwn=21000024ff8f05ef
add host initiator host_id=4 initiator_type=FC wwn=21000024ff4a4e24
add host initiator host_id=4 initiator_type=FC wwn=21000024ff4a4e25

create mapping_view name=mv mapping_view_id=1 lun_group_id=1 host_group_id=1
```

Step 3: Create Volumes on the Master Host System

Execute the [mkvolume.sh](#) script on the Master Host System to create 38 logical volumes as follows:

1. Create Physical Volume

Create 32 physical volumes using the **pvcreate** command.

2. Create Volumes Groups

Create one volume group (**vg1**) using the **vgcreate** command and the following 32 physical volumes:

```
/dev/sdb /dev/sdc /dev/sdd /dev/sde /dev/sdf /dev/sdg /dev/sdh /dev/sdi /dev/sdj /dev/sdk
/dev/sdl /dev/sdm /dev/sdn /dev/sdo /dev/sdp /dev/sdq /dev/sdr /dev/sds /dev/sdt /dev/sdu
/dev/sdv /dev/sdw /dev/sdx /dev/sdy /dev/sdz /dev/sdaa /dev/sdab /dev/sdac /dev/sdad
/dev/sdae /dev/sdaf /dev/sdag Create Logical Volumes
```

- Create 18 logical volumes, each with a capacity of 890 GiB, on **vg1** for ASU-1.
- Create 18 logical volumes, each with a capacity of 890GiB, on **vg1** for ASU-2.
- Create 2 logical volumes, each with a capacity of 1980 GiB, on **vg1** for ASU-3.

Step 4: Change the Scheduler on each Host System

Execute the [scheduler.sh](#) script on the Host System to change the I/O scheduler from cfq to noop on each Host System, which will result in all incoming I/O requests inserted into a simple, unordered FIFO queue.

Step 5: Change the `nr_requests` on each Host System

Execute the [nr_requests.sh](#) script on the Host System to change `nr_requests` from 128 to 4096 on each Host System for each device.

Step 6: Change the `aio-max-nr` on each Host System

Execute the [aio-max-nr.sh](#) script on the Host System to change the maximum number of AIO operations to 10485760.

Referenced Scripts

mklun.txt is a script including all the CLI commands to create disk domains, storage pools, LUNs.

mkvolume.sh is a Linux shell script, which is used to create Physical Volumes, Volume Groups, Logical Volumes.

collectinfo.sh shows profiles of the storage, including controllers, fans, powers, Disk Domains, storage pools, LUNs, mapping views and disks.

scheduler.sh is a Linux shell script, which is used to change the I/O scheduler from **cfq** to **noop** on each Host System, which will result in all incoming I/O requests inserted into a simple, unordered FIFO queue.

nr_requests.sh is a Linux shell script, which is used to change `nr_requests` from 128 to 2048 on each Host System for each device.

aio-max-nr.sh is a Linux shell script, which is used to change the maximum number of AIO operations to 10485760.

full_run.sh is a Linux shell script, executed on Master Host(host1), show profiles of the storage and volumes, run Init, Verify, Metrics, Repeat,Verify, Persist1 and Persist2 Test.

slave_asu.asu is a configuration file including all the ASU configuration.

host.HST is a configuration file including all hosts configuration.

APPENDIX E: CONFIGURATION INVENTORY

An inventory of the TSC was collected during the execution of the script `full_run.sh`. It generated the following log files.

- `profile1_storage.log` – list of configured storage before the INIT phase
- `profile1_volume.log` – list of configured volumes before the INIT phase
- `profile2_storage.log` – list of configured storage after TSC restart
- `profile2_volume.log` – list of configured volumes after TSC restart

The above log files are included in the Supporting Files (see Appendix A).

APPENDIX F: WORKLOAD GENERATOR

The ASUs accessed by the SPC-1 workload generator, are defined using the script `slave_asu.asu`.

The phases of the benchmark are executed using the script `full_run.sh`. The script pauses at the end of the `PERSIST_1` test phase. Once the TSC has been restarted, the `PERSIST_2` test phase is executed by pressing `ENTER` from the console where the script has been invoked.

The above scripts are included in the Supporting Files (see Appendix A).